



S&M
INDUSTRI SERVICE AB

Prislista 2022



Innehållsförteckning

Sid	Beskrivning
1	Omslag
2	Innehållsförteckning. Förord. Försäljningsvillkor
3	Slipprislista & materialfärgkodning
4	Precisionsbrotschar DIN 212
5	Precisionsbrotschar DIN 212 & 208 X-långa
6	Handbrotschar DIN 206
7	Maskinbrotschar DIN 208
8	Påsticksbrottsch & Dorn DIN 219 & 217
9	Koniska brotschar 1:10, 1:16, 1:20, MK DIN 204 & DIN 1895
10	Upprymmare DIN 343 & 344
11	Precisionsbrotschar HM DIN 8093
12	Brotschar m. lödda HM skär DIN 8050 & 8051
13	Brotschar m. utbytbart HM huvud "Modular"
14	Skärolja, spray & pasta. Flytande Brotschhållare o ER hylsor
15	Borrbussningar DIN 172 & 179
16	Produktöversikt
17-18	Skärdata
19	Övrigt
20	Baksida

Förord

Denna katalog innehåller ett bassortiment av de verktyg vi säljer. Vi har tillsammans med våra leverantörer möjlighet att erbjuda er många andra verktyg utöver detta sortiment. Vi specialanpassar verktyg i diameter och skaft på 1-3 dagar. Nedan ser ni loggorna för några av de leverantörer och samarbetspartners som vi jobbar mest med.



Försäljningsvillkor:

Priserna i denna katalog gäller från 2022-01-01 med reservation för eventuella ändringar i pris & sortiment. Alla angivna priser är riktpreise utan moms och frakt. Allmänna leveransbestämmelser gäller enligt NL 01.

Retur av varor:

För att en retur ska vara giltig måste varorna:

- Godkännas i skick och förpackning av Strömberg & Mulder Industriservice AB
- Vara oanvända och säljbara.
- Ingå i det aktuella sortimentet vid returtillfället.
- Skriftligt underlag med Ordernummer och/eller fakturanummer samt anledning till retur.
- Felbeställning eller ånkrat inköp debiteras med 20% eller enligt överenskommelse med Strömberg & Mulder Industriservice AB

Slipprislista & materialfärgkodning



Slippriser standard

HSS/E	DIN 212 / 208
Ø 4-23	400:- / st
Ø 24-31	500:- /st
Ø 32-40	600:- /st
Ø 41-50	750:- /st
HSS/E	DIN 206
Ø 4-13	450:- /st
Ø 14-20	550:- /st
Ø 21-30	700:- /st
Ø 31-40	850:- /st
HSS/E	DIN 219
Ø 20-40	600:- /st
Ø 41-60	750:- /st
Ø 61-80	900:- /st
HSS/E	DIN 343 / 344
Ø 5-20	450:- /st
Ø 21-30	600:- /st
Ø 31-40	750:- /st
HM	DIN 8050 / 8051 / 8093
Ø 4-13	450:- /st
Ø 14-20	500:- /st
Ø 21-30	600:- /st
Ø 31-40	750:- /st



“Verktøget rekommenderat för”
Materialrekommendation

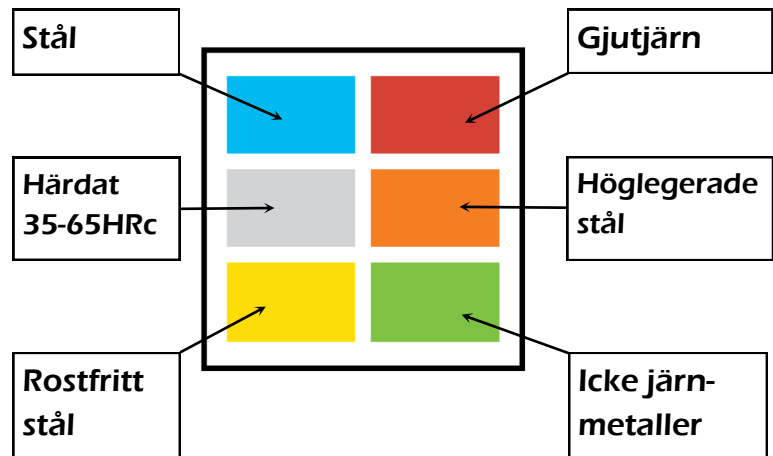

Slippriser Brotschar med utbytbart HM huvud “Modular”

Modular head Ø	Modifieringspris*	Omslipningspris*
15,0 - 19,9	600 kr	500 kr
20,0 - 24,9	750 kr	600 kr
25,0 - 29,9	950 kr	700 kr
30,0 - 34,9	1 125 kr	800 kr
35,0 - 40,0	1 250 kr	1 000 kr

*= Utan ombeläggning



Precisionsbrottsch HSSE DIN 212 Tolerans: $\varnothing + 0,003, -0,0$ & H7

För universellt bruk.

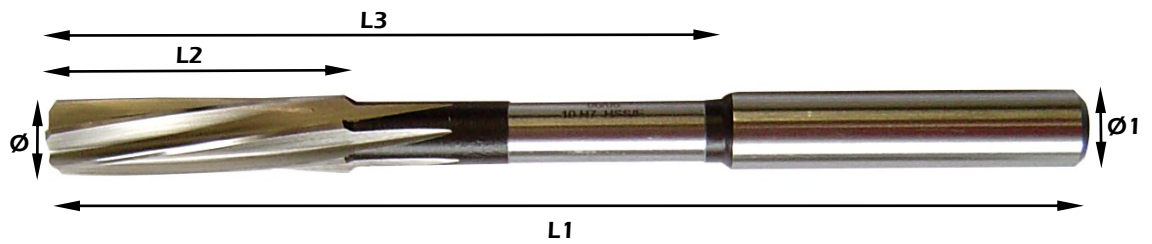

\varnothing	L2	L3	L1	$\varnothing 1$	Pris
0,70-0,79	5	15	33	\varnothing	460 kr
0,80-0,89	5	15	33	\varnothing	430 kr
0,90-1,06	5,5	15	34	1	300 kr
1,07-1,18	6,5	15,5	36	1,1	300 kr
1,19-1,32	8	16,5	38	1,2	300 kr
1,33-1,50	8	18	40	1,5	300 kr
1,51-1,70	9	20	43	1,6	280 kr
1,71-1,90	10	22	46	1,8	280 kr
1,91-2,12	11	24	49	2	280 kr
2,13-2,36	12	25	53	2,2	280 kr
2,37-2,65	14	29	57	2,5	260 kr
2,66-2,79	15	33	61	2,8	260 kr
2,80-2,89	15	33	61	2,8	260 kr
2,90-3,00	15	33	61	3	260 kr
3,01-3,35	16	37	65	3,2	260 kr
3,36-3,75	18	42	70	3,5	260 kr
3,76-4,25	19	47	75	4	250 kr
4,26-4,75	21	52	80	4,5	250 kr
4,76-5,30	23	58	86	5	250 kr
5,31-6,00	26	57	93	5,6	260 kr
6,01-6,70	28	65	101	6,3	270 kr
6,71-7,50	31	73	109	7,1	280 kr
7,51-8,50	33	81	117	8	320 kr
8,51-9,50	36	85	125	9	360 kr
9,51-10,60	38	93	133	10	400 kr
10,61-11,80	41	102	142	10	440 kr
11,81-12,25	44	111	151	10	500 kr
12,26-13,20	44	111	151	10	520 kr

\varnothing H7	L2	L3	L1	$\varnothing 1$	Pris
1.0	5.5	15	34	1.0	300 kr
1.5	8	18	40	1.5	260 kr
2.0	11	24	49	2.0	240 kr
2.5	14	29	57	2.5	240 kr
3.0	15	33	61	3.0	230 kr
3.5	18	42	70	3.5	260 kr
4.0	19	47	75	4.0	230 kr
4.5	21	52	80	4.5	240 kr
5.0	23	58	86	5.0	230 kr
5.5	26	57	93	5.6	260 kr
6.0	26	57	93	5.6	250 kr
6.5	28	65	101	6.3	280 kr
7.0	31	73	109	7.1	290 kr
7.5	33	73	109	7.1	300 kr
8.0	33	81	117	8.0	290 kr
8.5	36	81	117	8.0	350 kr
9.0	36	85	125	9.0	350 kr
9.5	38	93	133	9.0	360 kr
10.0	38	93	133	10.0	360 kr
10.5	38	93	133	10.0	440 kr
11.0	41	102	142	10.0	440 kr
11.5	41	102	142	10.0	500 kr
12.0	44	111	151	10.0	500 kr
13.0	44	111	151	10.0	560 kr
14.0	47	115	160	12.5	600 kr
15.0	50	117	162	12.5	650 kr
16.0	52	125	170	12.5	680 kr
17.0	54	130	175	14.0	780 kr
18.0	56	137	182	14.0	820 kr
19.0	58	141	189	16.0	940 kr
20.0	60	147	195	16.0	920 kr

Precisionsbrottsch HSSE DIN 212 & 208 H7 X-lång

För universellt bruk.

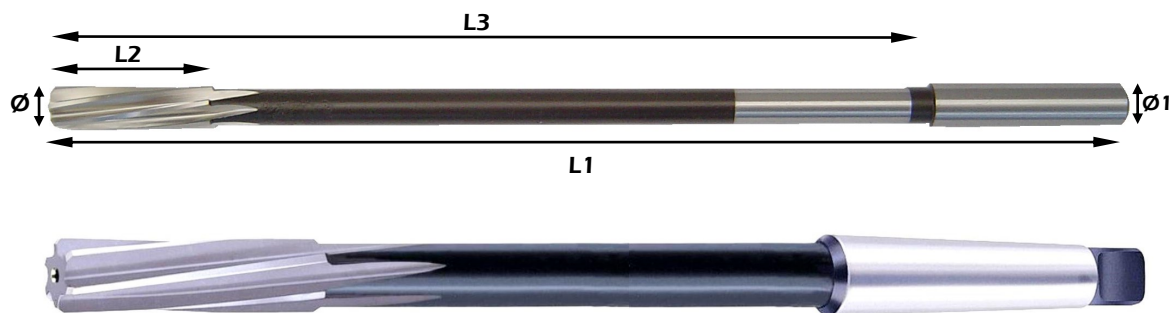

DIN 212 X-lång					
Ø H7	L2	L3	L1	Ø1	Pris
2.0	11	45	65	2.0	850 kr
2.5	14	55	75	2.5	850 kr
3.0	15	65	90	3.0	640 kr
3.5	18	65	90	3.5	930 kr
4.0	19	70	105	4.0	640 kr
4.5	21	70	105	4.5	990 kr
5.0	23	80	115	5.0	690 kr
5.5	26	80	115	5.5	1 050 kr
6.0	26	90	130	6.0	700 kr
6.0	26	210	250	6.0	1 600 kr
6.5	28	90	130	6.0	1 100 kr
7.0	31	95	140	7.0	750 kr
7.5	31	95	140	7.0	1 100 kr
8.0	33	115	160	8.0	750 kr
8.0	33	205	250	8.0	1 650 kr
8.5	33	115	160	8.0	1 150 kr
9.0	36	130	175	9.0	850 kr
10.0	38	140	190	10.0	850 kr
10.0	38	200	250	10.0	1 650 kr
11.0	41	150	200	10.0	950 kr
11.0	41	200	250	10.0	2 300 kr
12.0	44	160	210	12.0	950 kr
12.0	44	200	250	10.0	2 300 kr
13.0	44	200	250	10.0	2 300 kr
14.0	47	200	250	14.0	2 400 kr

DIN 208 X-lång					
Ø H7	L2	L3	L1	MK	Pris
12.0	44	245	315	1	2 100 kr
13.0	44	180	245	1	1 100 kr
14.0	47	180	245	1	1 100 kr
15.0	50	180	260	2	1 200 kr
16.0	52	180	260	2	1 250 kr
16.0	52	270	350	2	3 650 kr
18.0	56	180	260	2	1 350 kr
18.0	56	270	350	2	3 800 kr
20.0	60	190	270	2	1 400 kr
20.0	60	270	350	2	4 100 kr
22.0	64	200	280	2	1 700 kr
24.0	68	220	300	3	2 100 kr
25.0	68	220	320	3	2 600 kr
26.0	70	230	330	3	3 000 kr
28.0	71	210	310	3	3 100 kr
30.0	73	250	350	3	3 200 kr

Handbrotschar, cylindriskt skaft med 4-kant, HSS DIN 206 H7

För universellt bruk.

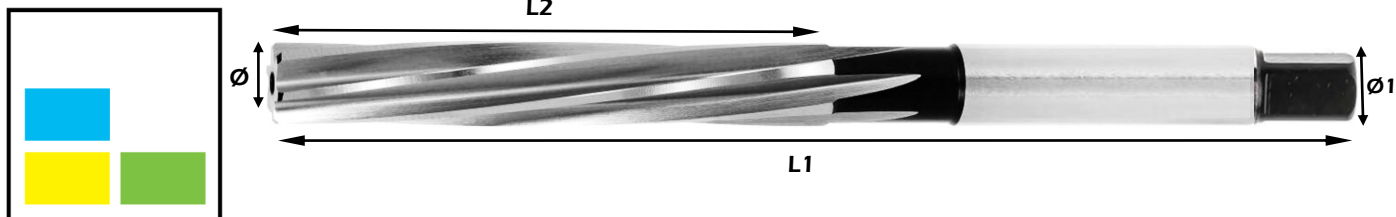

Ø H7	L2	L1	Ø1 e9	Fyrkant	Pris
2.0	25	50	2.0	1,6	280 kr
2.5	29	58	2.5	2,0	280 kr
3.0	31	62	3.0	2,24	280 kr
3.5	35	71	3.5	2,8	330 kr
4.0	38	76	4.0	3,15	270 kr
4.5	41	81	4.5	3,55	330 kr
5.0	44	87	5.0	4	310 kr
5.5	47	93	6.0	4,5	350 kr
6.0	47	93	6.0	4,5	320 kr
6.5	50	100	6.5	5	380 kr
7.0	54	107	7.0	5,6	320 kr
8.0	58	115	8.0	6,3	330 kr
9.0	62	124	9.0	7,1	370 kr
10.0	66	133	10.0	8	370 kr
11.0	71	142	11.0	9	420 kr
12.0	76	152	12.0	10	460 kr
13.0	76	152	13.0	10	650 kr
14.0	81	163	14.0	11,2	710 kr
15.0	81	163	15.0	11,2	760 kr
16.0	87	175	16.0	12,5	800 kr
17.0	87	175	17.0	12,5	870 kr
18.0	93	188	18.0	14	900 kr
19.0	93	188	19.0	14	980 kr
20.0	100	201	20.0	16	980 kr
21.0	100	201	21.0	16	1 230 kr
22.0	107	215	22.0	18	1 120 kr
23.0	107	215	23.0	18	1 400 kr
24.0	115	231	24.0	20	1 400 kr
25.0	115	231	25.0	20	1 400 kr
30.0	124	247	30.0	22,4	1 900 kr
35.0	142	284	35.0	28	2 600 kr
40.0	152	305	40.0	31,5	3 600 kr

Maskinbrottsch HSSE DIN 208

För universellt bruk.



Ø H7	L3	L2	L1	MK	Pris
4	60	19	125	1	560 kr
5	68	23	133	1	560 kr
6	73	26	138	1	560 kr
7	85	31	150	1	595 kr
8	91	33	156	1	595 kr
9	97	36	162	1	683 kr
10	102	38	168	1	504 kr
11	110	41	175	1	562 kr
12	116	44	182	1	562 kr
13	116	44	182	1	605 kr
14	123	47	189	1	607 kr
15	124	50	204	2	720 kr
16	130	52	210	2	731 kr
17	134	54	214	2	776 kr
18	139	56	219	2	802 kr
19	143	58	223	2	848 kr
20	148	60	228	2	848 kr
21	152	62	232	2	965 kr
22	157	64	237	2	962 kr
23	161	66	241	2	1 117 kr
24	169	68	268	3	1 122 kr
25	169	68	268	3	1 170 kr
26	174	70	273	3	1 264 kr
27	178	71	277	3	1 394 kr
28	178	71	277	3	1 396 kr
29	182	73	281	3	1 650 kr
30	182	73	281	3	1 439 kr
31	186	75	285	3	2 050 kr
32	193	77	317	4	1 890 kr
33	193	77	317	4	2 300 kr
34	197	78	321	4	2 300 kr
35	197	78	321	4	2 200 kr
36	201	79	325	4	2 500 kr
37	201	79	325	4	2 950 kr
38	205	81	329	4	2 700 kr
39	205	81	329	4	3 400 kr
40	205	81	329	4	2 800 kr

Ø H7	L3	L2	L1	MK	Pris
41	209	82	333	4	3 500 kr
42	209	82	333	4	3 100 kr
43	212	83	336	4	3 800 kr
44	212	83	336	4	3 600 kr
45	212	83	336	4	3 600 kr
46	216	84	340	4	4 200 kr
47	216	84	340	4	4 300 kr
48	220	86	344	4	4 300 kr
49	220	86	344	4	4 800 kr
50	220	86	344	4	4 400 kr
52	236	90	360	4	7 500 kr
53	236	90	360	4	8 200 kr
55	236	90	360	4	8 600 kr
56	236	90	360	4	8 600 kr
58	234	90	390	5	8 900 kr
60	234	90	390	5	8 900 kr

Dorn DIN 217 & Påsticksbrosch HSSE DIN 219 H7

För universellt bruk.

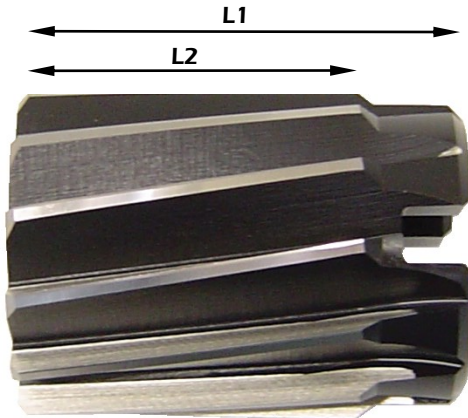

Ø	MK	Område DIN219	Totalängd	Pris
10	2	20-24	216	1 600 kr
13	3	25-30	250	1 800 kr
16	3	31-35	261	2 150 kr
19	4	36-42	298	2 400 kr
22	4	43-50	312	2 650 kr
27	4	51-60	359	3 000 kr
32	4	61-71	345	3 300 kr
40	5	72-85	396	4 600 kr
50	5	86-100	416	9 300 kr

Ø H7	L2	L1	Hål Ø	Pris
20	28	40	10	1 300 kr
21	28	40	10	1 300 kr
22	28	40	10	1 300 kr
23	28	40	10	1 300 kr
24	32	45	13	1 400 kr
25	32	45	13	1 600 kr
26	32	45	13	1 700 kr
27	32	45	13	2 000 kr
28	32	45	13	1 700 kr
29	32	45	13	2 100 kr
30	32	45	13	1 700 kr
31	36	50	16	2 150 kr
32	36	50	16	1 900 kr
33	36	50	16	2 050 kr
34	36	50	16	2 050 kr
35	36	50	16	2 050 kr
36	40	56	19	2 150 kr
37	40	56	19	2 500 kr
38	40	56	19	2 200 kr
39	40	56	19	2 800 kr
40	40	56	19	2 050 kr
41	40	56	19	2 600 kr
42	40	56	19	2 150 kr
43	45	63	22	3 500 kr
44	45	63	22	2 900 kr
45	45	63	22	2 900 kr

Ø H7	L2	L1	Hål Ø	Pris
46	45	63	22	2 900 kr
47	45	63	22	2 900 kr
48	45	63	22	2 800 kr
50	45	63	22	2 750 kr
52	50	71	27	3 700 kr
55	50	71	27	3 600 kr
56	50	71	27	5 100 kr
58	50	71	27	3 800 kr
60	50	71	27	3 800 kr
62	56	80	32	5 100 kr
65	56	80	32	5 200 kr
68	56	80	32	6 100 kr
70	56	80	32	5 800 kr
72	63	90	40	7 700 kr
75	63	90	40	7 700 kr
78	63	90	40	8 700 kr
80	63	90	40	8 800 kr
82	63	90	40	10 600 kr
85	63	90	40	10 600 kr
88	71	100	50	11 000 kr
90	71	100	50	11 000 kr
92	71	100	50	14 000 kr
95	71	100	50	14 000 kr
98	71	100	50	15 000 kr
100	71	100	50	15 000 kr

Koniska brotschar HSS

För universellt bruk.



1:10					
Diam Ø	Min Ø	Max Ø	L2	L1	Pris
3 x 10	3	10	70	100	800 kr
5 x 15	5	15	100	140	1 100 kr
10 x 25	10	25	150	195	2 200 kr
15 x 35	15	35	200	250	4 100 kr
23 x 45	23	45	220	275	5 300 kr
30 x 55	30	55	250	310	8 400 kr

1:20					
Ø	Min Ø	Max Ø	L2	L1	Pris
2 x 5	2.0	5.0	60	85	820 kr
2.5 x 5.5	2.5	5.5	60	85	850 kr
3 x 7	3.0	7.0	80	110	1 000 kr
3.5 x 7.5	3.5	7.5	80	110	1 000 kr
4 x 8	4.0	8.0	80	120	1 050 kr
4.5 x 9	4.5	9.0	90	130	1 100 kr
5 x 9.5	5.0	9.5	90	130	1 300 kr
5.5 x 10	5.5	10.0	90	130	1 400 kr
6 x 11	6.0	11.0	100	140	1 550 kr
7 x 12	7.0	12.0	100	140	1 600 kr
8 x 14	8.0	14.0	125	165	1 800 kr
9 x 15	9.0	15.0	125	165	2 100 kr
10 x 16	10.0	16.0	125	165	2 800 kr



DIN 9 1:50					
Ø	Min Ø	Max Ø	L2	L1	Pris
2	1.9	2.86	48	68	440 kr
3	2.9	4.06	58	80	400 kr
4	3.9	5.25	68	93	430 kr
5	4.9	6.36	73	100	470 kr
6	5.9	8.00	105	135	580 kr
7	6.9	9.72	141	177	850 kr
8	7.9	10.80	145	180	850 kr
9	8.9	12.16	163	205	1 180 kr
10	9.9	13.40	175	215	1 180 kr
12	11.8	16.00	210	255	1 450 kr
16	15.8	20.40	230	280	1 900 kr
20	19.8	24.80	250	310	2 600 kr
25	24.7	30.70	300	370	4 300 kr
30	29.7	36.10	320	400	5 600 kr



DIN 204					
MK	Min	Max	L2	L1	Pris
0	6.547	9.722	61	93	690 kr
1	9.571	12.863	66	102	790 kr
2	14.733	18.679	79	121	990 kr
3	20.010	24.829	96	146	1 450 kr
4	26.229	32.410	119	179	2 400 kr
5	37.873	45.767	150	222	5 000 kr
6	54.172	65.016	208	300	12 000 kr



DIN 1895					
2	14.733	18.679	79	173	2 185 kr
3	20.010	24.829	96	212	2 645 kr
4	26.229	32.410	119	263	3 105 kr

1:16 (Nr 1)					
Dim	Min Ø	Max Ø	L2	L1	Pris
1/16"	5.935	6.998	17	70	1 600 kr
1/8"	8.042	9.105	17	70	1 750 kr
1/4"	10.308	11.996	27	80	2 000 kr
3/8"	13.728	15.416	27	85	2 300 kr
1/2"	16.938	19.126	35	95	3 100 kr
3/4"	22.253	24.411	35	105	3 600 kr
1"	27.996	30.684	43	130	4 800 kr



MK = MK
(Gäller DIN 1895)

Upprymmare HSS DIN 344 & DIN 343

För universellt bruk.

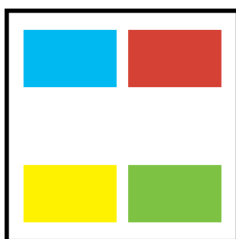

MK DIN 343				
Ø h8	L2	L1	MK	Pris
7.8	75	156	1	700 kr
8.0	75	156	1	700 kr
8.8	81	162	1	740 kr
9.0	81	162	1	740 kr
9.8	87	168	1	740 kr
10.0	87	168	1	740 kr
10.75	94	175	1	740 kr
11.0	94	175	1	740 kr
11.75	94	175	1	740 kr
12.0	101	182	1	740 kr
12.75	101	182	1	820 kr
13.0	101	182	1	820 kr
13.75	108	189	1	850 kr
14.0	108	189	1	850 kr
14.75	114	212	2	900 kr
15.0	114	212	2	900 kr
15.75	120	218	2	930 kr
16.0	120	218	2	930 kr
16.75	125	223	2	980 kr
17.0	125	223	2	980 kr
17.75	130	228	2	1 070 kr
18.0	130	228	2	1 070 kr
18.7	135	233	2	1 150 kr
19.0	135	233	2	1 150 kr
19.7	140	238	2	1 150 kr
20.0	140	238	2	1 150 kr
20.7	145	243	2	1 300 kr
21.0	145	243	2	1 300 kr
21.7	150	248	2	1 400 kr
22.0	150	248	2	1 400 kr
22.7	155	253	2	1 500 kr
23.0	155	253	2	1 500 kr
23.7	160	281	3	1 550 kr
24.0	160	281	3	1 550 kr
24.7	160	281	3	1 700 kr
25.0	160	281	3	1 700 kr
25.7	165	286	3	1 750 kr
26.0	165	286	3	1 750 kr
26.7	170	291	3	2 000 kr
27.0	170	291	3	2 000 kr
27.7	170	291	3	2 050 kr
28.0	170	291	3	2 050 kr
28.7	175	296	3	2 250 kr
29.0	175	296	3	2 250 kr

MK DIN 343				
Ø h8	L2	L1	MK	Pris
29.7	175	296	3	2 300 kr
30.0	175	296	3	2 300 kr
30.6	180	301	3	2 750 kr
31.0	180	301	3	2 750 kr
31.6	185	334	4	2 950 kr
32.0	185	334	4	2 950 kr
32.6	185	334	4	3 150 kr
33.0	185	334	4	3 150 kr
33.6	190	339	4	3 300 kr
34.0	190	339	4	3 300 kr
34.6	190	339	4	3 500 kr
35.0	190	339	4	3 500 kr
36.0	195	344	4	3 700 kr
37.0	195	344	4	3 900 kr
38.0	200	349	4	4 000 kr
39.0	200	349	4	4 200 kr
40.0	200	349	4	4 300 kr

Cylindrisk DIN 344			
Ø h8	L2	L1	Pris
3.0	55	84	850 kr
4.0	64	96	850 kr
4.8	74	108	440 kr
5.0	74	108	440 kr
5.8	80	116	440 kr
6.0	80	116	440 kr
6.8	93	133	450 kr
7.0	93	133	450 kr
7.8	100	142	500 kr
8.0	100	142	500 kr
8.8	107	151	580 kr
9.0	107	151	580 kr
9.8	116	162	600 kr
10.0	116	162	600 kr
10.75	125	173	770 kr
11.0	125	173	770 kr
11.75	134	184	770 kr
12.0	134	184	770 kr
12.75	134	184	880 kr
13.0	134	184	880 kr
13.75	142	194	1 000 kr
14.0	142	194	1 000 kr

Precisionsbrotsch HM DIN 8093

För universellt bruk.

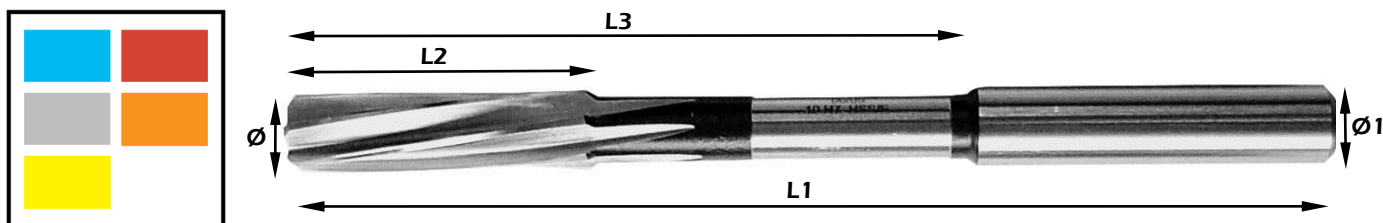

Ø	L2	L3	L1	Ø1 h6	Pris
0.90-1.30	6	20	34	1.0	430 kr
1.31-1.50	8	24	40	2.0	430 kr
1.51-1.70	9	25	43	2.0	430 kr
1.71-1.90	10	28	46	2.0	430 kr
1.91-2.12	11	29	49	2.0	430 kr
2.13-2.36	12	32	53	3.0	430 kr
2.37-2.65	14	34	57	3.0	430 kr
2.66-3.09	15	41	61	3.0	430 kr
3.10-3.35	16	41	65	4.0	460 kr
3.36-3.75	18	43	70	4.0	460 kr
3.76-4.10	19	43	75	4.0	510 kr
4.11-4.25	21	47	80	4.0	580 kr
4.26-4.75	21	47	80	5.0	620 kr
4.76-5.20	23	52	86	5.0	590 kr
5.21-6.00	26	57	93	6.0	620 kr
6.01-6.60	28	63	101	6.0	690 kr
6.61-6.70	31	69	109	6.0	750 kr
6.71-7.50	31	69	109	8.0	820 kr
7.51-8.50	33	75	117	8.0	880 kr
8.51-9.50	36	81	125	10.0	1 050 kr
9.51-10.60	38	87	133	10.0	1 150 kr
10.61-11.80	41	96	142	10.0	1 350 kr
11.81-12.25	44	105	151	10.0	1 400 kr
12.26-13.20	44	105	151	10.0	1 700 kr

Ø H7	L2	L3	L1	Ø1 h6	Pris
1.0	6	20	34	1.0	370 kr
1.5	8	24	40	2.0	370 kr
2.0	11	29	49	2.0	370 kr
2.5	14	34	57	3.0	370 kr
3.0	15	41	61	3.0	390 kr
3.5	18	43	70	4.0	430 kr
4.0	19	43	75	4.0	440 kr
4.5	21	47	80	5.0	510 kr
5.0	23	52	86	5.0	510 kr
5.5	26	57	93	6.0	630 kr
6.0	26	57	93	6.0	580 kr
6.5	28	63	101	6.0	740 kr
7.0	31	69	109	8.0	780 kr
7.5	33	75	117	8.0	850 kr
8.0	33	75	117	8.0	830 kr
8.5	36	81	125	10.0	900 kr
9.0	36	81	125	10.0	950 kr
9.5	38	87	133	10.0	1 080 kr
10.0	38	87	133	10.0	1 100 kr
10.5	41	96	142	10.0	1 200 kr
11.0	41	96	142	10.0	1 350 kr
11.5	44	105	151	10.0	1 650 kr
12.0	44	105	151	10.0	1 400 kr
13.0	44	105	151	10.0	1 700 kr
14.0	47	110	160	14.0	1 800 kr
15.0	50	112	162	14.0	2 050 kr
16.0	52	120	170	14.0	2 100 kr
17.0	54	123	175	14.0	2 400 kr
18.0	56	130	182	14.0	2 600 kr
19.0	58	131	189	16.0	3 000 kr
20.0	60	137	195	16.0	3 250 kr

Brotsch med Hårdmetallskär DIN 8050 & DIN 8051

För universellt bruk.



DIN 8050 Cyl. skaft

Ø H7	L2	L1	Skaft	Pris
5.0	12	90	5	650 kr
6.0	12	93	5.6	650 kr
7.0	16	109	7.1	700 kr
8.0	16	117	8	700 kr
9.0	19	125	9	750 kr
10.0	19	133	10	800 kr
11.0	19	142	10	1 100 kr
12.0	19	151	10	1 150 kr
13.0	19	151	10	1 200 kr

DIN 8051 MK skaft

Ø H7	L2	L3	L1	MK	Pris
8	16	91	156	1	1 000 kr
9	19	97	162	1	1 100 kr
10	19	102	168	1	950 kr
11	19	110	175	1	1 250 kr
12	19	116	182	1	1 100 kr
13	19	116	182	1	1 200 kr
14	19	123	189	1	1 200 kr
15	19	124	204	2	1 300 kr
16	22	130	210	2	1 200 kr
17	22	134	214	2	1 250 kr
18	22	139	219	2	1 200 kr
19	22	143	223	2	1 300 kr
20	22	148	228	2	1 250 kr
21	25	152	232	2	1 350 kr
22	25	157	237	2	1 350 kr
23	25	161	241	2	1 700 kr
24	25	169	268	3	1 750 kr
25	25	169	268	3	1 750 kr
26	25	174	273	3	1 850 kr
27	30	178	277	3	2 200 kr
28	30	178	277	3	2 100 kr
29	30	182	281	3	2 200 kr
30	30	182	281	3	2 200 kr
31	30	186	285	3	2 400 kr
32	30	193	317	4	2 400 kr
34	30	197	321	4	2 900 kr
35	30	197	321	4	2 900 kr
40	30	205	329	4	3 400 kr

Brotsch med utbytbart HM huvud "Modular"

För universellt bruk.

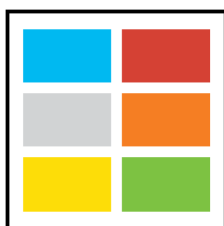

Huvud Ø H7	S	Z	pris
15	12	6	1 232 kr
15,5	12	6	1 232 kr
16	12	6	1 232 kr
16,5	12	6	1 232 kr
17	12	6	1 232 kr
17,5	13	6	1 680 kr
18,0	13	6	1 680 kr
18,5	13	6	1 680 kr
19,0	13	6	1 680 kr
19,5	13	6	1 680 kr
20,0	15	8	2 324 kr
20,5	15	8	2 324 kr
21	15	8	2 324 kr
21,5	15	8	2 324 kr
22,0	15	8	2 324 kr
22,5	17	8	2 940 kr
23,0	17	8	2 940 kr
23,5	17	8	2 940 kr
24,0	17	8	2 940 kr
24,5	17	8	2 940 kr
25,0	18	10	3 696 kr
25,5	18	10	3 696 kr
26,0	18	10	3 696 kr



Huvud Ø H7	S	Z	pris
26,5	18	10	3 696 kr
27	18	10	3 696 kr
27,5	18	10	4 680 kr
28,0	20	10	4 680 kr
28,5	20	10	4 680 kr
29,0	20	10	4 680 kr
29,5	20	10	4 680 kr
30,0	22	10	5 462 kr
30,5	22	10	5 462 kr
31,0	22	10	5 462 kr
31,5	22	10	5 462 kr
32,0	22	10	5 462 kr
32,5	24	10	6 864 kr
33	24	10	6 864 kr
33,5	24	10	6 864 kr
34,0	24	10	6 864 kr
34,5	24	10	6 864 kr
35,0	25	12	8 396 kr
35,5	25	12	8 396 kr
36,0	25	12	8 396 kr
36,5	25	12	8 396 kr
37,0	25	12	8 396 kr
37,5	27	12	9 980 kr
38,0	27	12	9 980 kr
38,5	27	12	9 980 kr
39	27	12	9 980 kr
39,5	27	12	9 980 kr
40,0	27	12	9 980 kr

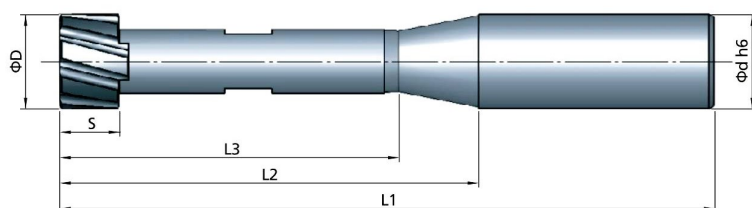

Skafst för Ø	L1	L2	L3	Ød h6	Pris
15-17,4	153	103	92	20	2 442 kr
17,5-19,9	169	119	105	20	2 442 kr
20-22,4	185	135	118	20	2 442 kr
22,5-24,9	209	153	131	25	2 755 kr
25-27,4	221	165	145	25	2 755 kr
27,5-29,9	245	185	158	32	3 270 kr
30-32,4	257	197	170	32	3 980 kr
32,5-34,9	270	210	183	32	3 980 kr
35-37,4	300	230	195	40	4 643 kr
37,5-40	313	243	208	40	4 643 kr

Skärolja, Spray & Pasta för skärande/formande bearbetning

För universellt bruk.

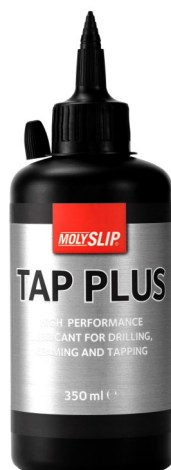

Artikelkod	Benämning	Pris
51191612	Skäroljespray TAP Plus 400ml	305 kr
51191614	Skärolja TAP Plus 350ml	326 kr
51191616	Skärpasta TAP Plus 0,45kg	360 kr

Flytande brotschhållare och ER hylsor

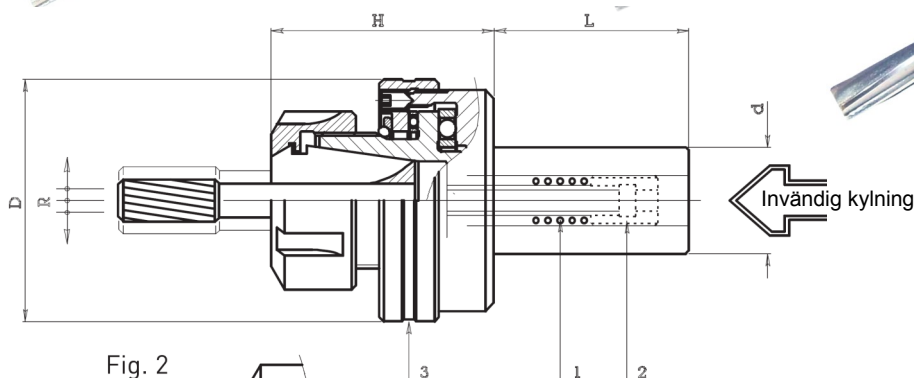
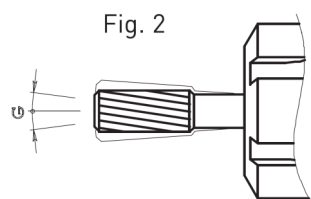

Fig. 2



Nr	Beskrivning
1	Fjäder som centrerar verktyget
2	Skruv för justering av "floating" nivå
3	Mutter som styr om chucken ska flyta enl Fig. 2

Art.nummer ER 20	d	pris
5203ER2001	1	224 kr
5203ER2002	2	224 kr
5203ER2003	3	224 kr
5203ER2004	4	224 kr
5203ER2005	5	224 kr
5203ER2006	6	224 kr
5203ER2007	7	224 kr
5203ER2008	8	224 kr
5203ER2009	9	224 kr
5203ER2010	10	224 kr
5203ER2011	11	224 kr
5203ER2012	12	224 kr
5203ER2013	13	224 kr
5203ER20SET	1-13	2 714 kr

Art Nr	d	D	H	L	R	Hylsa	Pris
5211.155.102	MK 2	50	50	69	1	ER 20	4 862 kr
5211.155.120	20	50	50	46	1	ER20	3 967 kr

Borrbussningar DIN 179 (SMS 718) & DIN 172 (SMS 719)

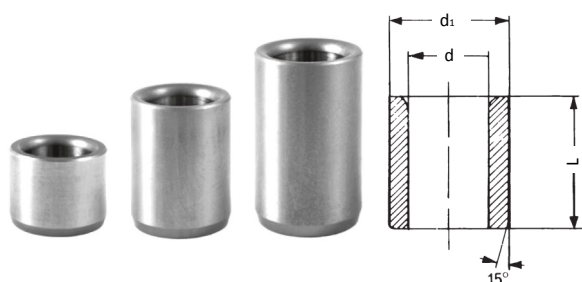

d F7	d1 n6	L	Pris	L	Pris	L	Pris
0.5	3	6	200 kr	9	255 kr		
0.6	3	6	110 kr	9	255 kr		
0.7	3	6	81 kr	9	255 kr		
0.8	3	6	81 kr	9	121 kr		
0.9-1.0	3	6	58 kr	9	71 kr		
1.1-1.8	4	6	39 kr	9	44 kr		
1.9-2.6	5	6	28 kr	9	32 kr		
2.7-3.3	6	8	31 kr	12	32 kr	16	52 kr
3.4-4.0	7	8	31 kr	12	33 kr	16	51 kr
4.1-5.0	8	8	33 kr	12	37 kr	16	52 kr
5.1-6.0	10	10	33 kr	16	40 kr	20	58 kr
6.1-8.0	12	10	39 kr	16	44 kr	20	64 kr
8.1-10.0	15	12	44 kr	20	49 kr	25	71 kr
10.1-12	18	12	49 kr	20	56 kr	25	79 kr
12.1-15	22	16	51 kr	28	70 kr	36	95 kr
15.1-18	26	16	103 kr	28	130 kr	36	164 kr
18.1-22	30	20	130 kr	36	164 kr	45	233 kr
22.1-26	35	20	152 kr	36	192 kr	45	245 kr
26.5-30	42	25	188 kr	45	214 kr	56	270 kr
30.5-35	48	25	197 kr	45	255 kr	56	
36-42	55	30	313 kr	56	454 kr	67	
43-48	62	30		56			
49-55	70	30		56			
56-62	78	35		67			

d F7	d1 n6	d3	L1	L	Pris	L	Pris	L	Pris
0.5	3	6	2	6	255 kr				
0.6	3	6	2	6	255 kr				
0.7	3	6	2	6	190 kr				
0.8	3	6	2	6	102 kr				
0.9-1.0	3	6	2	6	82 kr	9	91 kr		
1.1-1.8	4	7	2	6	52 kr	9	58 kr		
1.9-2.6	5	8	2	6	40 kr	9	44 kr		
2.7-3.3	6	9	2.5	8	42 kr	12	44 kr	16	80 kr
3.4-4.0	7	10	2.5	8	44 kr	12	46 kr	16	78 kr
4.1-5.0	8	11	2.5	8	44 kr	12	46 kr	16	80 kr
5.1-6.0	10	13	3	10	45 kr	16	50 kr	20	84 kr
6.1-8.0	12	15	3	10	51 kr	16	56 kr	20	86 kr
8.1-10.0	15	18	3	12	56 kr	20	59 kr	25	96 kr
10.1-12	18	22	4	12	59 kr	20	68 kr	25	110 kr
12.1-15	22	26	4	16	71 kr	28	93 kr	36	141 kr
15.1-18	26	30	4	16	130 kr	28	175 kr	36	200 kr
18.1-22	30	34	5	20	175 kr	36	233 kr	45	272 kr
22.1-26	35	39	5	20	217 kr	36	281 kr	45	325 kr
26.5-30	42	46	5	25	255 kr	45	298 kr	56	390 kr
30.5-35	48	52	5	25	289 kr	45	364 kr	56	
36-42	55	59	5	30	427 kr	56	562 kr	67	
43-48	62	66	6	30		56			
49-55	70	74	6	30		56			
56-62	78	82	6	35		67			

Produkter vi kan leverera med kort leveranstid

Vissa dimensioner har vi på lager.

Toolwork brotschar



CPK pinnar



Passbult



Stans DIN 9861 HSS Form D

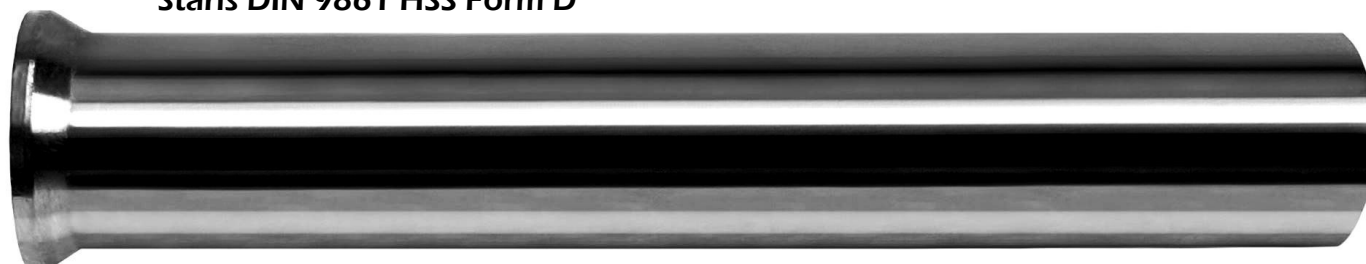

Skärdata

Material group	Nr	V _C (m/min) f _R a _R	HSS reamer	HSS coated reamer	HM reamer	HM coated reamer	Cermet reamer	PCD/PCB reamer
Soft plastics	0	V _C f _R a _R	12-14 1 2		20-30 2 2			
Hard plastics	1	V _C f _R a _R	8-12 3 3		10-15 2 2	20-60 2 1		80-160 8 1
Machining steel	2	V _C f _R a _R	10-15 4 2	10-15 4 2	15-20 4 2	20-30 4 2	40-75 4 2	
Constructional steel	3	V _C f _R a _R	12-18 3 3	14-20 3 3	20-25 3 2	25-40 4 2	50-80 4 2	
Low-alloy steels	4	V _C f _R a _R	10-15 4 2	12-16 4 2	15-20 4 2	20-30 4 2	40-75 4 2	
Tempering steel	5	V _C f _R a _R	8-12 4 2	8-12 4 2	15-20 5 2	20-30 5 2	30-40 4 2	75-200 2 4
Tool steel	6	V _C f _R a _R	4-6 5 1	4-6 5 1	12-15 5 1	15-25 5 2	25-35 4 4	80-150 4 4
High tensile steels	7	V _C f _R a _R			8-12 6 1	10-15 6 1	15-25 4 4	80-150 4 4
Stainless steel	8	V _C f _R a _R			10-15 4 1	15-40 4 1	30-40 4 1	
Ditto with Mo-content	9	V _C f _R a _R			8-12 4 1	12-30 4 1	25-35 4 1	
Ditto austenitic	10	V _C f _R a _R			8-12 4 1	12-30 4 1	15-25 4 1	
Low-hardness cast iron	11	V _C f _R a _R	10-14 1 2	10-14 1 2	15-18 1 2	30-120 3 1	60-120 3 1	90-180 8 4
Low-alloy cast iron	12	V _C f _R a _R	8-12 3 2	8-12 3 2	12-15 3 2	30-120 3 1	60-120 3 1	90-180 8 4
Alloyed cast iron, medium hardness	13	V _C f _R a _R	4-6 5 2	4-6 5 2	8-12 5 2	20-80 3 1	30-80 3 1	90-180 8 4
High-alloy cast iron	14	V _C f _R a _R			6-10 5 2	15-30 5 2	20-40 5 2	90-180 8 4
Al, Mg, Zn	15	V _C f _R a _R	14-20 3 3		30-60 3 3		100-200 3 3	100-300 8 1
Al, Cu, Bronze	16	V _C f _R a _R			25-40 3 3		50-150 3 3	100-300 8 1
Inconel, Monel <30 HRC	17	V _C f _R a _R	6-8 4 2		8-12 4 2	15-18 4 2	15-18 4 2	
Inconel, Monel >30 HRC	18	V _C f _R a _R	4-6 4 2		5-8 4 2	10-15 4 2	10-15 4 2	
Ti, Ti-alloys	19	V _C f _R a _R	4-6 5 1		8-12 3 1	15-30 3 1		

V_C - cutting speed (m/min)

f_R, a_R - see Tables of feeds and over-measures

Skärdata och borrekommendationer

Series of feeds f_R	Feed f (mm/U) for drilling diameter:								
	Diameter (mm)								
	<5	5	8	10	15	20	30	40	50
1	0,2	0,2	0,25	0,3	0,35	0,4	0,5	0,6	0,7
2	0,3	0,3	0,35	0,35	0,4	0,45	0,55	0,6	0,7
3	0,15	0,2	0,25	0,25	0,3	0,35	0,45	0,5	0,6
4	0,1	0,15	0,2	0,2	0,25	0,3	0,4	0,45	0,5
5	0,08	0,1	0,12	0,15	0,2	0,25	0,3	0,35	0,4
6	0,08	0,1	0,12	0,15	0,18	0,2	0,25	0,3	0,35
7	0,05	0,06	0,08	0,12	0,15	0,18	0,3	0,32	0,35
8			0,3	0,4	0,6	0,8	1,2		

Series of over-measures a_R	Dimension a (mm) in drill hole with hole diameter:								
	Diameter (mm)								
	<5	5	8	10	15	20	30	40	50
1	0,1	0,1	0,15	0,2	0,25	0,25	0,3	0,3	0,4
2	0,15	0,15	0,2	0,25	0,25	0,3	0,35	0,4	0,45
3	0,15	0,2	0,25	0,25	0,3	0,35	0,4	0,45	0,5
4	0,08	0,1	0,12	0,15	0,2	0,25	0,25	0,3	0,35

Vi kan special vi modifierar standardbroschar i diameter & skaft i egen verkstad. Specialbroschar efter ritning från vår fabrik i Tyskland. Förlängning av skärande verktyg.

Förlängning av brotschar och andra skärande verktyg. Leveranstid från 1-2 veckor.



Förlängd brotsch innan inslipning av mått



Special brotsch x-kort med bitsfäste



Special konisk brotsch x-kort



Vi hjälper företag från ett tidigt stadie oftast som idé. Med våra 8st 3-D printers kan vi ta fram allt från demo detaljer till färdiga produkter. Vi ritat även upp produkten i 3D-CAD

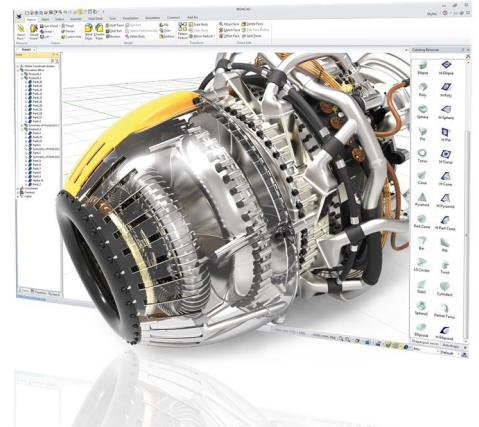

Bolag som ingår i vår verksamhet

CUTTING EDGE
abce.se

aim
Air Tool Matic AB



S&M INDUSTRISERVICE AB



Magnus Kuritzén Tekniker, administration	Kontor: 08-87 12 10 el 09 Mobil: 0708-87 12 10 info@smindustriservice.se
Henry Mulder Tekniker, marknadsansvarig	Kontor: 08-87 12 10 el 09 info@smindustriservice.se
Jonas Ivarsson Tekniker, marknadsansvarig specialverktyg	Mobil: 0708-87 12 60 jonas@abce.se jonas@smindustriservice.se
Morgan Fredriksson Regionschef	Mobil: 073-955 71 97 morgan@smindustriservice.se
Marie Kuritzén Ekonomiansvarig	Kontor: 08-87 12 10 el 09 info@smindustriservice.se

Strömberg & Mulder Industriservice AB

Produktion: Östra Ingelstad 7902, 273 94 Tomelilla

Administration: Sadelmakarvägen 6 / Box 552, 146 33 Tullinge

Telefon: 08-659 00 30 el 32

Info@smindustriservice.se

www.smindustriservice.se