

## BOX HBF F400



### AXIAL FAN IN SOUNDPROOF CABINET 400°C/2H

#### MANUFACTURING FEATURES

- BOX: Manufactured in galvanised steel sheet with thermalproofing. Soundproofing cabinets with thermo-acoustic insulation, Bs1d0 fire class. Removable panels for easy motor access and fan maintenance.
- Internal fan: HBF F400 Axial fan, circular reinforced frame from size 45 to 80. For larger sizes uses from 90 to 125 we use model HCF F400. Motor-impeller assembly through a modular system. Cast aluminium impeller. Polyester powder finishing coat to protect against corrosion.
- Standard asynchronous squirrel-cage motor with IP-55 protection and Class H insulation certified 400°C/2H. Manufactured with standard voltages: 230/400V 50Hz in three phase motors up to 3kW and 400V 50Hz for higher powers and 2 speed motors. IE3 efficiency motor from 0,75kW up to 45kW in single speed

#### APPLICATIONS

- Designed for wall or duct installation, they are suitable for:
- Smoke emergency exhaust with motor inside the hazardous area.
  - Cabinet design simplifies installation in rectangular duct systems.
  - Maximum working temperature: 60°C.

## Accessories



#### UNDER REQUEST

- Supply 100% reversible impeller.

Official homologation by the European laboratory APPLUS according to EN 12101-3:2015  
 Certification Nr: 0370-CPR-0913

## Technical data

### Three-phase motor / 4 poles

Code	Model	Angle	Min. Rated power kW	Max. Rated power kW	Max. Airflow m <sup>3</sup> /h	Sound db (A)**	Weight t*	Connect. diagram
-	BOX HBF 45 T4 (A5:6) F400	20° - 45°	0,75	0,75	6.170	51	58,10	1
-	BOX HBF 50 T4 (A5:6) F400	20° - 45°	0,75	0,75	10.210	52	62,60	1
-	BOX HBF 56 T4 (A5:6) F400	20° - 45°	0,75	1,50	14.480	67	79,60	1
-	BOX HBF 63 T4 (A5:6) F400	20° - 45°	0,75	2,20	20.110	71	83,90	1
-	BOX HBF 71 T4 (A5:6) F400	20° - 45°	0,75	3	27.220	76	107,20	1
-	BOX HBF 80 T4 (A5:6) F400	20° - 45°	2,20	4	37.370	73	113,20	1
-	BOX HBF 90 T4 (A3:4) F400	20° - 42°	3	15	48.110	70	178,10	1
-	BOX HBF 90 T4 (A3:8) F400	20° - 42°	3	15	54.810	75	183,20	1
-	BOX HBF 100 T4 (A3:4) F400	20° - 42°	5,50	22	67.210	69	192,20	1
-	BOX HBF 100 T4 (A3:8) F400	20° - 42°	5,50	22	77.810	78	197,80	1
-	BOX HBF 112 T4 (A3:4) F400	20° - 42°	7,50	37	92.110	73	255,60	1
-	BOX HBF 112 T4 (A3:8) F400	20° - 42°	7,50	37	104.010	80	261,70	1
-	BOX HBF 125 T4 (A3:4) F400	20° - 42°	11	45	124.010	80	266,80	1
-	BOX HBF 125 T4 (A3:8) F400	20° - 42°	11	45	141.010	86	273,40	1

### Three-phase motor / 6 poles

Code	Model	Angle	Min. Rated power kW	Max. Rated power kW	Max. Airflow m <sup>3</sup> /h	Sound db (A)**	Weight t*	Connect. diagram
-	BOX HBF 45 T6 (A5:6) F400	25° - 45°	0,75	0,75	4.060	42	58,10	1
-	BOX HBF 50 T6 (A5:6) F400	25° - 45°	0,75	0,75	5.950	46	62,60	1
-	BOX HBF 56 T6 (A5:6) F400	20° - 45°	0,75	0,75	9.660	64	79,60	1
-	BOX HBF 63 T6 (A5:6) F400	20° - 45°	0,75	0,75	13.410	68	83,90	1
-	BOX HBF 71 T6 (A5:6) F400	20° - 45°	0,75	0,75	18.150	73	107,20	1
-	BOX HBF 80 T6 (A5:6) F400	20° - 45°	0,75	2,20	24.910	69	113,20	1
-	BOX HBF 90 T6 (A3:4) F400	20° - 42°	1,50	5,50	31.210	60	178,10	1
-	BOX HBF 90 T6 (A3:8) F400	20° - 42°	1,50	5,50	35.510	65	183,20	1
-	BOX HBF 100 T6 (A3:4) F400	20° - 42°	1,50	7,50	43.610	60	192,20	1
-	BOX HBF 100 T6 (A3:8) F400	20° - 42°	1,50	7,50	50.410	68	197,80	1
-	BOX HBF 112 T6 (A3:4) F400	20° - 42°	2,20	11	59.710	63	255,60	1
-	BOX HBF 112 T6 (A3:8) F400	20° - 42°	2,20	11	67.610	70	261,70	1

Code	Model	Angle	Min. Rated power kW	Max. Rated power kW	Max. Airflow w m3/h	Sound db (A)**	Weigh t*	Connect. diagram
-	BOX HBF 125 T6 (A3:4) F400	20° - 42°	3	15	80.610	70	266,80	1
-	BOX HBF 125 T6 (A3:8) F400	20° - 42°	3	15	91.410	77	273,40	1

## 2 SPEED MOTOR / 4/8 poles

Code	Model	Angle	Min. Rated power kW	Max. Rated power kW	Max. Airflow w m3/h	Sound db (A)**	Weigh t*	Connect. diagram
-	BOX HBF 45 T4/T8 (A5:6) F400	20° - 45°	0,60	1,60	7.310	48	58,10	1
-	BOX HBF 50 T4/T8 (A5:6) F400	20° - 45°	0,60	1,60	10.210	52	62,60	1
-	BOX HBF 56 T4/T8 (A5:6) F400	20° - 45°	0,60	2,80	14.480	67	79,60	2
-	BOX HBF 63 T4/T8 (A5:6) F400	20° - 45°	0,60	2,80	20.110	71	83,90	2
-	BOX HBF 71 T4/T8 (A5:6) F400	20° - 45°	0,60	4	27.220	76	107,20	2
-	BOX HBF 80 T4/T8 (A5:6) F400	20° - 45°	1,20	7,50	37.370	73	113,20	2
-	BOX HBF 90 T4/T8 (A3:4) F400	20° - 42°	2,80	17	48.110	70	178,10	2
-	BOX HBF 90 T4/T8 (A3:8) F400	20° - 42°	5,50	17	54.810	75	183,20	2
-	BOX HBF 100 T4/T8 (A3:4) F400	20° - 42°	5,50	20	67.210	69	192,20	2
-	BOX HBF 100 T4/T8 (A3:8) F400	20° - 42°	5,50	20	77.810	78	197,80	2
-	BOX HBF 112 T4/T8 (A3:4) F400	20° - 42°	5,50	37	92.110	73	255,60	2
-	BOX HBF 112 T4/T8 (A3:8) F400	20° - 42°	5,50	37	104.010	80	261,70	2
-	BOX HBF 125 T4/T8 (A3:4) F400	20° - 42°	7,50	44	124.010	80	266,80	2
-	BOX HBF 125 T4/T8 (A3:8) F400	20° - 42°	7,50	44	141.010	86	273,40	2

**Notes:**

\* The motor is not included in fan weight

\*\* Total sound pressure level at the point of maximum flow measured in dB(A) in the suction measured in free field at a distance of 6m from the source

## Dimensions

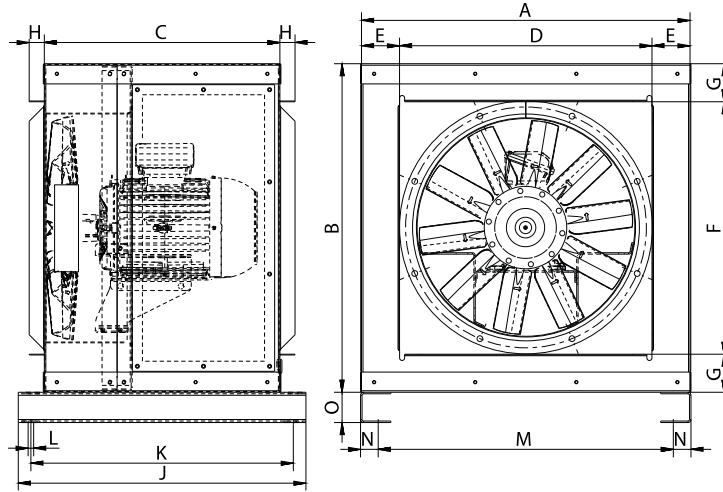

Model	A	B	C	D	E	F	G	H	J
BOX HBF 45 T4 (A5:6) F400	651	651	467	500	75	500	75	30	570
BOX HBF 45 T6 (A5:6) F400	651	651	467	500	75	500	75	30	570
BOX HBF 45 T4/T8 (A5:6) F400	651	651	467	500	75	500	75	30	570
BOX HBF 50 T4 (A5:6) F400	651	651	467	500	75	500	75	30	570
BOX HBF 50 T6 (A5:6) F400	651	651	467	500	75	500	75	30	570
BOX HBF 50 T4/T8 (A5:6) F400	651	651	467	500	75	500	75	30	570
BOX HBF 56 T4 (A5:6) F400	781.5	781.5	542	630	76	630	76	30	665
BOX HBF 56 T6 (A5:6) F400	781.5	781.5	542	630	76	630	76	30	665
BOX HBF 56 T4/T8 (A5:6) F400	781.5	781.5	542	630	76	630	76	30	665
BOX HBF 63 T4 (A5:6) F400	781.5	781.5	542	630	76	630	76	30	665
BOX HBF 63 T6 (A5:6) F400	781.5	781.5	542	630	76	630	76	30	665
BOX HBF 63 T4/T8 (A5:6) F400	781.5	781.5	542	630	76	630	76	30	665
BOX HBF 71 T4 (A5:6) F400	951.5	951.5	597	800	76	800	76	30	705
BOX HBF 71 T6 (A5:6) F400	951.5	951.5	597	800	76	800	76	30	705
BOX HBF 71 T4/T8 (A5:6) F400	951.5	951.5	597	800	76	800	76	30	705
BOX HBF 80 T4 (A5:6) F400	951.5	951.5	597	800	76	800	76	30	705
BOX HBF 80 T6 (A5:6) F400	951.5	951.5	597	800	76	800	76	30	705
BOX HBF 80 T4/T8 (A5:6) F400	951.5	951.5	597	800	76	800	76	30	705
BOX HBF 90 T4 (A3:4) F400	1176.5	1176.5	857	1000	88	1000	88	30	965
BOX HBF 90 T4 (A3:8) F400	1176.5	1176.5	857	1000	88	1000	88	30	965
BOX HBF 90 T6 (A3:4) F400	1176.5	1176.5	857	1000	88	1000	88	30	965
BOX HBF 90 T6 (A3:8) F400	1176.5	1176.5	857	1000	88	1000	88	30	965
BOX HBF 90 T4/T8 (A3:4) F400	1176.5	1176.5	857	1000	88	1000	88	30	965
BOX HBF 90 T4/T8 (A3:8) F400	1176.5	1176.5	857	1000	88	1000	88	30	965
BOX HBF 100 T4 (A3:4) F400	1176.5	1176.5	857	1000	88	1000	88	30	965

Model	A	B	C	D	E	F	G	H	J
BOX HBF 100 T4 (A3:8) F400	1176.5	1176.5	857	1000	88	1000	88	30	965
BOX HBF 100 T6 (A3:4) F400	1176.5	1176.5	857	1000	88	1000	88	30	965
BOX HBF 100 T6 (A3:8) F400	1176.5	1176.5	857	1000	88	1000	88	30	965
BOX HBF 100 T4/T8 (A3:4) F400	1176.5	1176.5	857	1000	88	1000	88	30	965
BOX HBF 100 T4/T8 (A3:8) F400	1176.5	1176.5	857	1000	88	1000	88	30	965
BOX HBF 112 T4 (A3:4) F400	1416.5	1416.5	1019	1250	83	1250	82	30	1125
BOX HBF 112 T4 (A3:8) F400	1416.5	1416.5	1019	1250	83	1250	82	30	1125
BOX HBF 112 T6 (A3:4) F400	1416.5	1416.5	1019	1250	83	1250	82	30	1125
BOX HBF 112 T6 (A3:8) F400	1416.5	1416.5	1019	1250	83	1250	82	30	1125
BOX HBF 112 T4/T8 (A3:4) F400	1416.5	1416.5	1019	1250	83	1250	82	30	1125
BOX HBF 112 T4/T8 (A3:8) F400	1416.5	1416.5	1019	1250	83	1250	82	30	1125
BOX HBF 125 T4 (A3:4) F400	1416.5	1416.5	1019	1250	83	1250	82	30	1125
BOX HBF 125 T4 (A3:8) F400	1416.5	1416.5	1019	1250	83	1250	82	30	1125
BOX HBF 125 T6 (A3:4) F400	1416.5	1416.5	1019	1250	83	1250	82	30	1125
BOX HBF 125 T6 (A3:8) F400	1416.5	1416.5	1019	1250	83	1250	82	30	1125
BOX HBF 125 T4/T8 (A3:4) F400	1416.5	1416.5	1019	1250	83	1250	82	30	1125
BOX HBF 125 T4/T8 (A3:8) F400	1416.5	1416.5	1019	1250	83	1250	82	30	1125

Model	K	L	M	N	O
BOX HBF 45 T4 (A5:6) F400	520	11	585	35	60
BOX HBF 45 T6 (A5:6) F400	520	11	585	35	60
BOX HBF 45 T4/T8 (A5:6) F400	520	11	585	35	60
BOX HBF 50 T4 (A5:6) F400	520	11	585	35	60
BOX HBF 50 T6 (A5:6) F400	520	11	585	35	60
BOX HBF 50 T4/T8 (A5:6) F400	520	11	585	35	60
BOX HBF 56 T4 (A5:6) F400	610	11	715	35	60
BOX HBF 56 T6 (A5:6) F400	610	11	715	35	60
BOX HBF 56 T4/T8 (A5:6) F400	610	11	715	35	60
BOX HBF 63 T4 (A5:6) F400	610	11	715	35	60
BOX HBF 63 T6 (A5:6) F400	610	11	715	35	60
BOX HBF 63 T4/T8 (A5:6) F400	610	11	715	35	60
BOX HBF 71 T4 (A5:6) F400	650	11	885	35	60
BOX HBF 71 T6 (A5:6) F400	650	11	885	35	60
BOX HBF 71 T4/T8 (A5:6) F400	650	11	885	35	60
BOX HBF 80 T4 (A5:6) F400	650	11	885	35	60
BOX HBF 80 T6 (A5:6) F400	650	11	885	35	60
BOX HBF 80 T4/T8 (A5:6) F400	650	11	885	35	60
BOX HBF 90 T4 (A3:4) F400	915	11	1110	35	90
BOX HBF 90 T4 (A3:8) F400	915	11	1110	35	90
BOX HBF 90 T6 (A3:4) F400	915	11	1110	35	90

Model	K	L	M	N	O
BOX HBF 90 T6 (A3:8) F400	915	11	1110	35	90
BOX HBF 90 T4/T8 (A3:4) F400	915	11	1110	35	90
BOX HBF 90 T4/T8 (A3:8) F400	915	11	1110	35	90
BOX HBF 100 T4 (A3:4) F400	915	11	1110	35	90
BOX HBF 100 T4 (A3:8) F400	915	11	1110	35	90
BOX HBF 100 T6 (A3:4) F400	915	11	1110	35	90
BOX HBF 100 T6 (A3:8) F400	915	11	1110	35	90
BOX HBF 100 T4/T8 (A3:4) F400	915	11	1110	35	90
BOX HBF 100 T4/T8 (A3:8) F400	915	11	1110	35	90
BOX HBF 112 T4 (A3:4) F400	1075	11	1350	35	90
BOX HBF 112 T4 (A3:8) F400	1075	11	1350	35	90
BOX HBF 112 T6 (A3:4) F400	1075	11	1350	35	90
BOX HBF 112 T6 (A3:8) F400	1075	11	1350	35	90
BOX HBF 112 T4/T8 (A3:4) F400	1075	11	1350	35	90
BOX HBF 112 T4/T8 (A3:8) F400	1075	11	1350	35	90
BOX HBF 125 T4 (A3:4) F400	1075	11	1350	35	90
BOX HBF 125 T4 (A3:8) F400	1075	11	1350	35	90
BOX HBF 125 T6 (A3:4) F400	1075	11	1350	35	90
BOX HBF 125 T6 (A3:8) F400	1075	11	1350	35	90
BOX HBF 125 T4/T8 (A3:4) F400	1075	11	1350	35	90
BOX HBF 125 T4/T8 (A3:8) F400	1075	11	1350	35	90

# Wiring diagram

DIAGRAM N° 1

230/400V

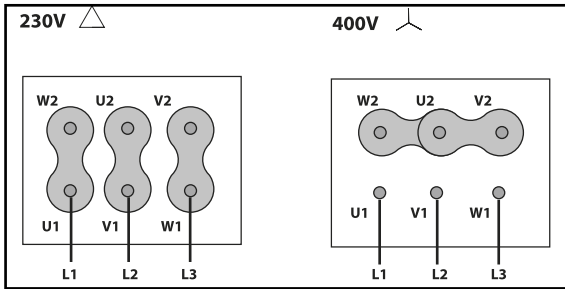

400/690V

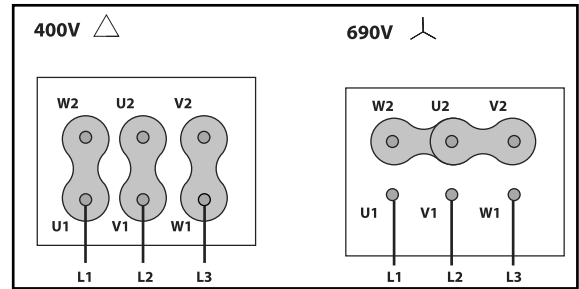
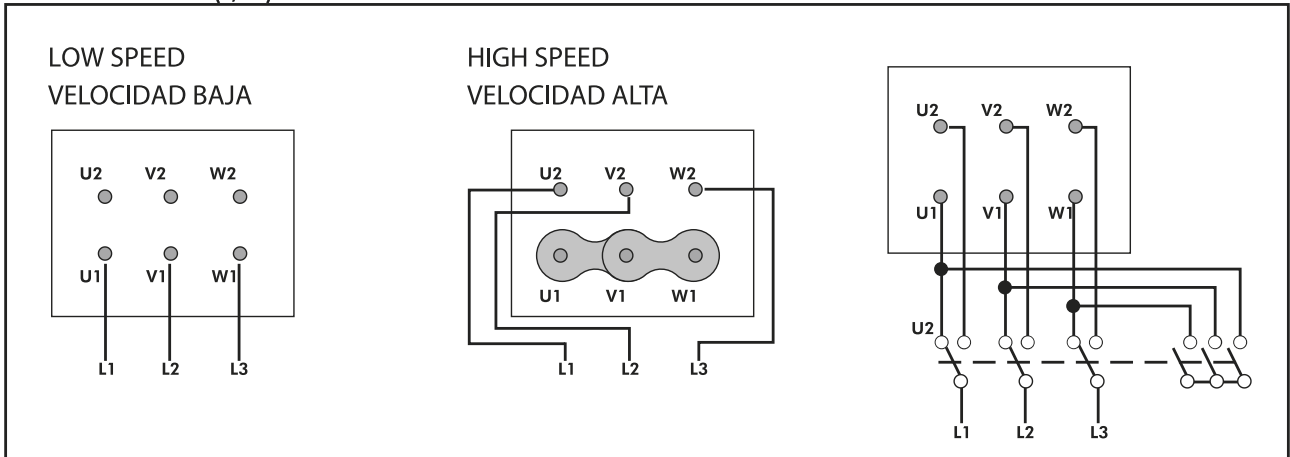

DIAGRAM N° 2

400V DAHLANDER (Y,YY)



# CHARACTERISTIC CURVE

BOX HBF 45 T4 (A5:6) F400

## AIR FLOW - PRESSURE

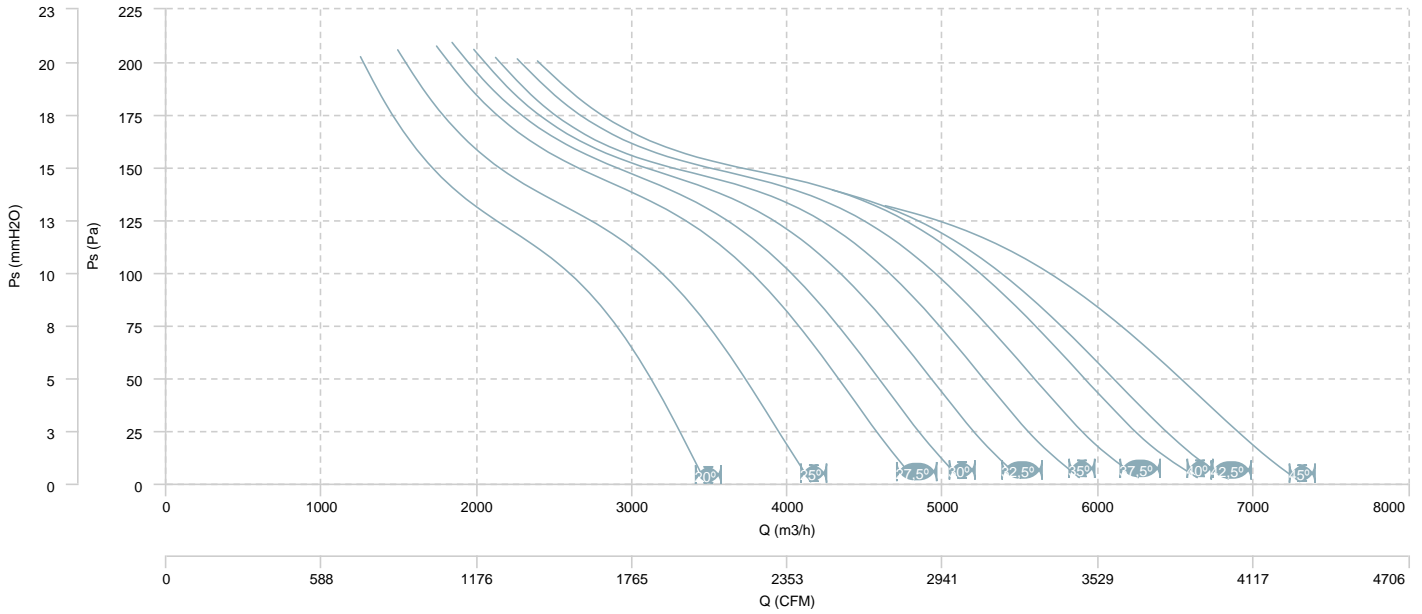

## AIR FLOW - MECHANICAL POWER

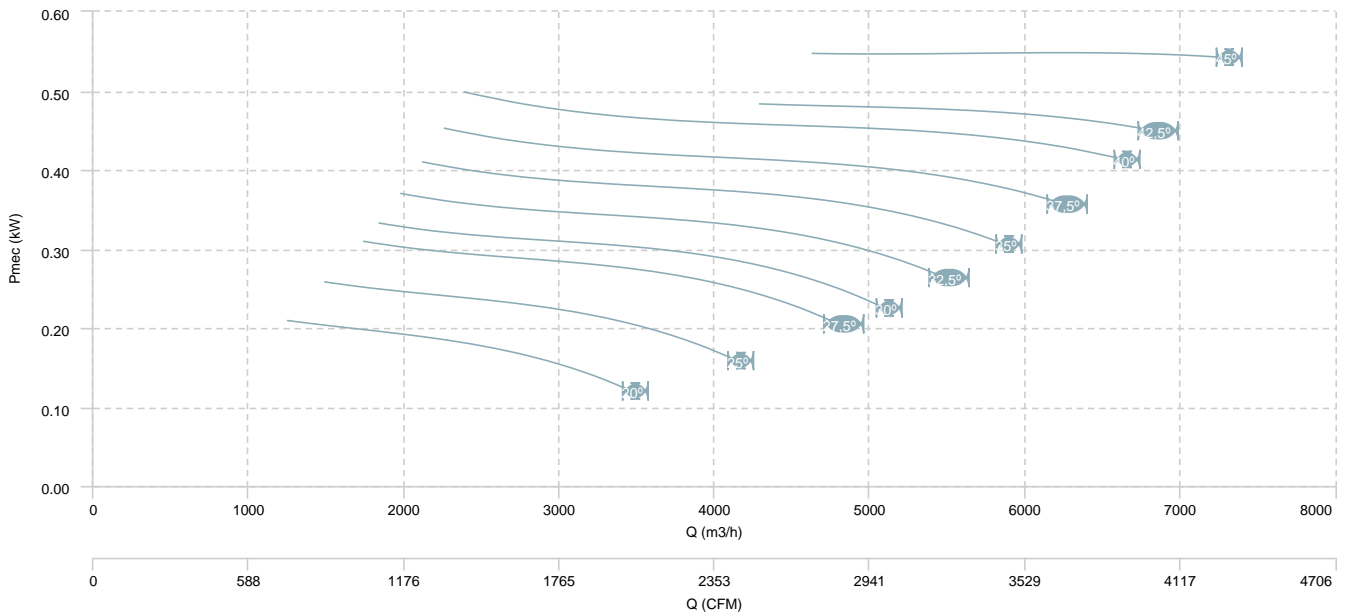



BOX HBF 45 T6 (A5:6) F400

AIR FLOW - PRESSURE

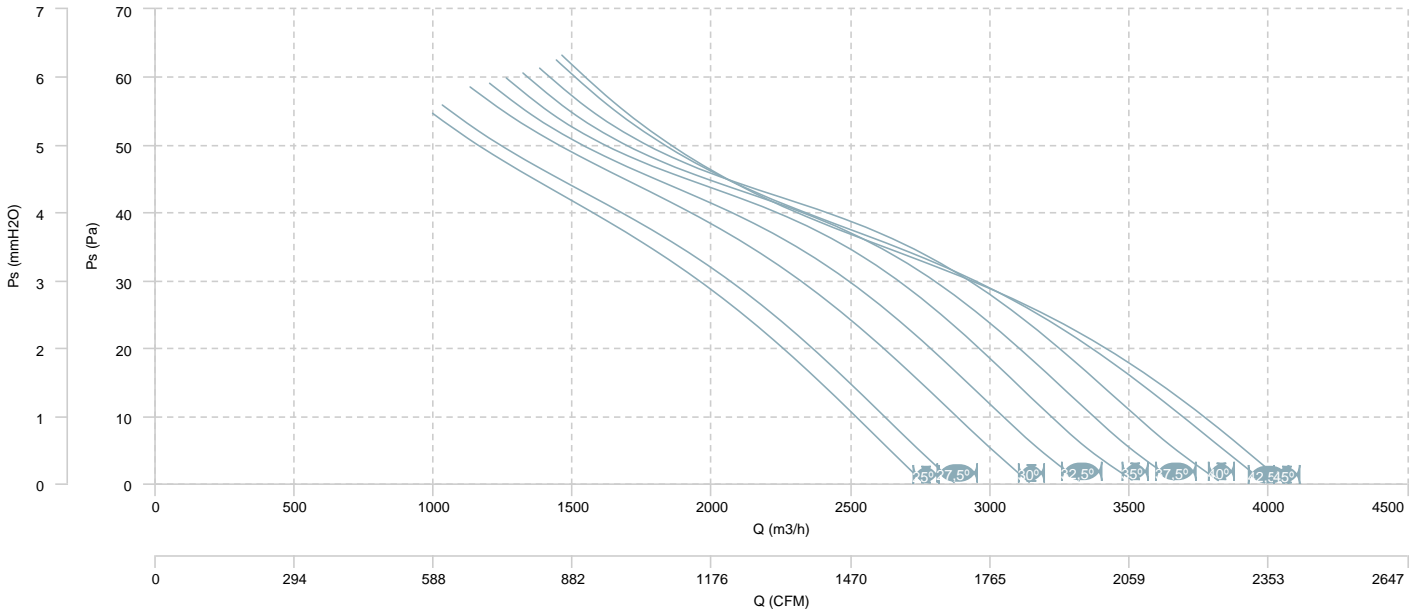

AIR FLOW - MECHANICAL POWER

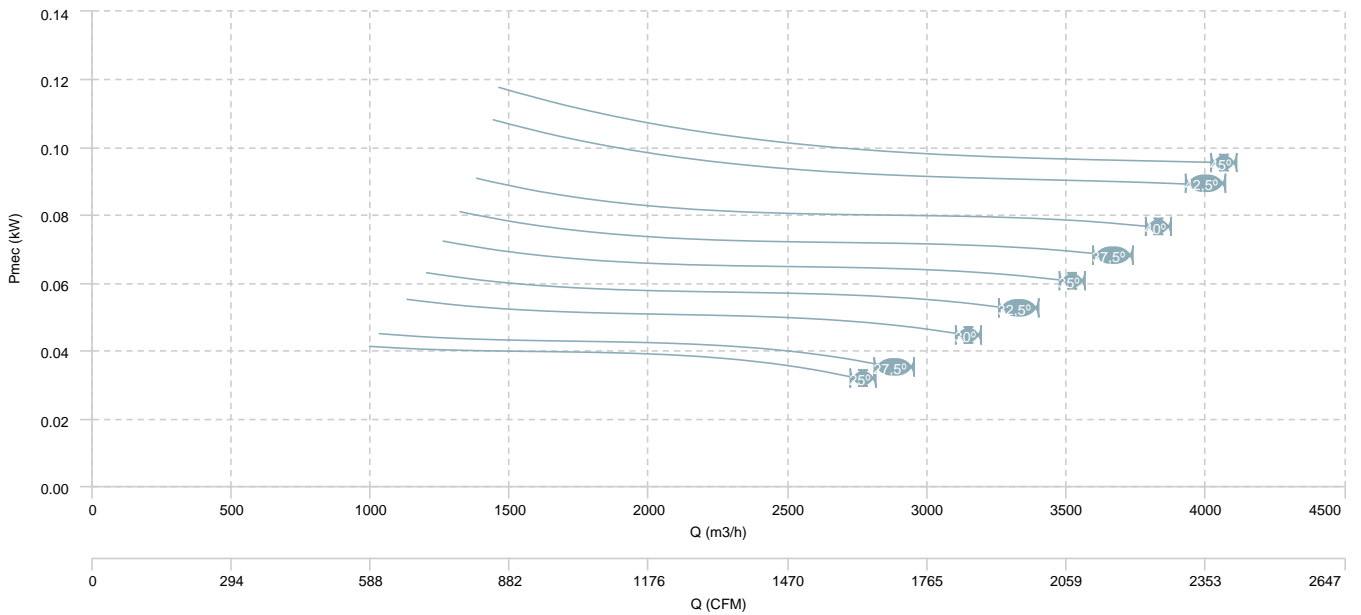

BOX HBF 45 T4/T8 (A5:6) F400

AIR FLOW - PRESSURE (4 poles)

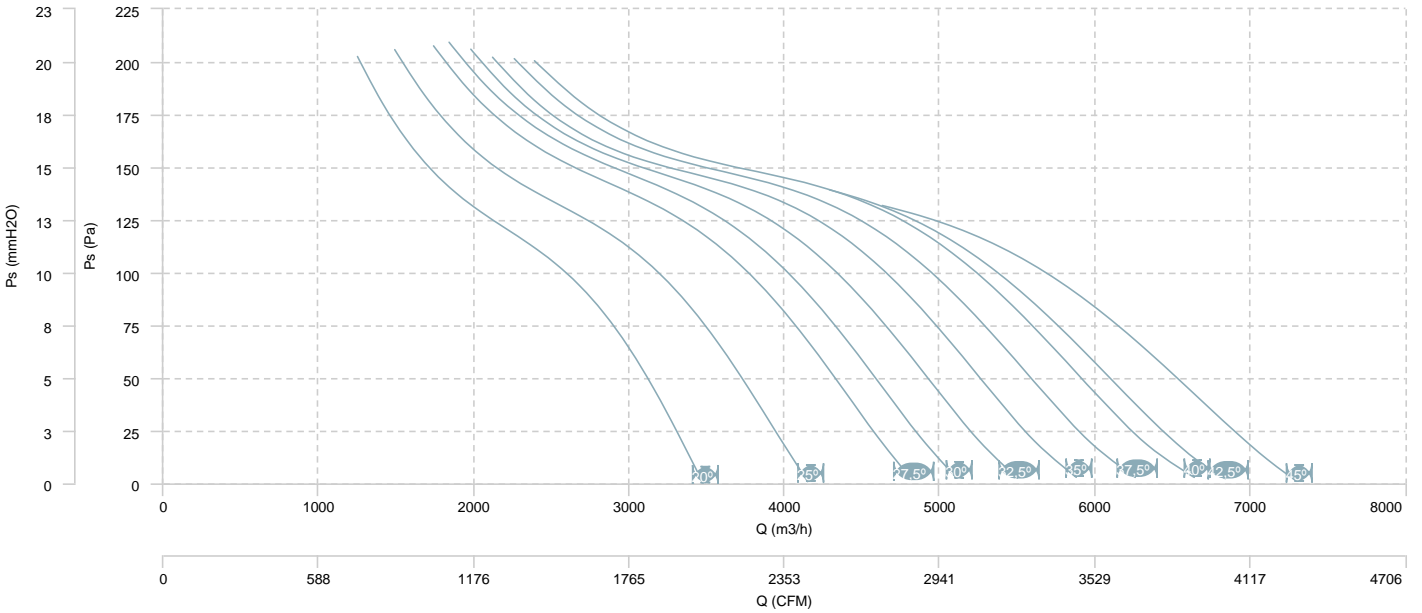

AIR FLOW - MECHANICAL POWER (4 poles)

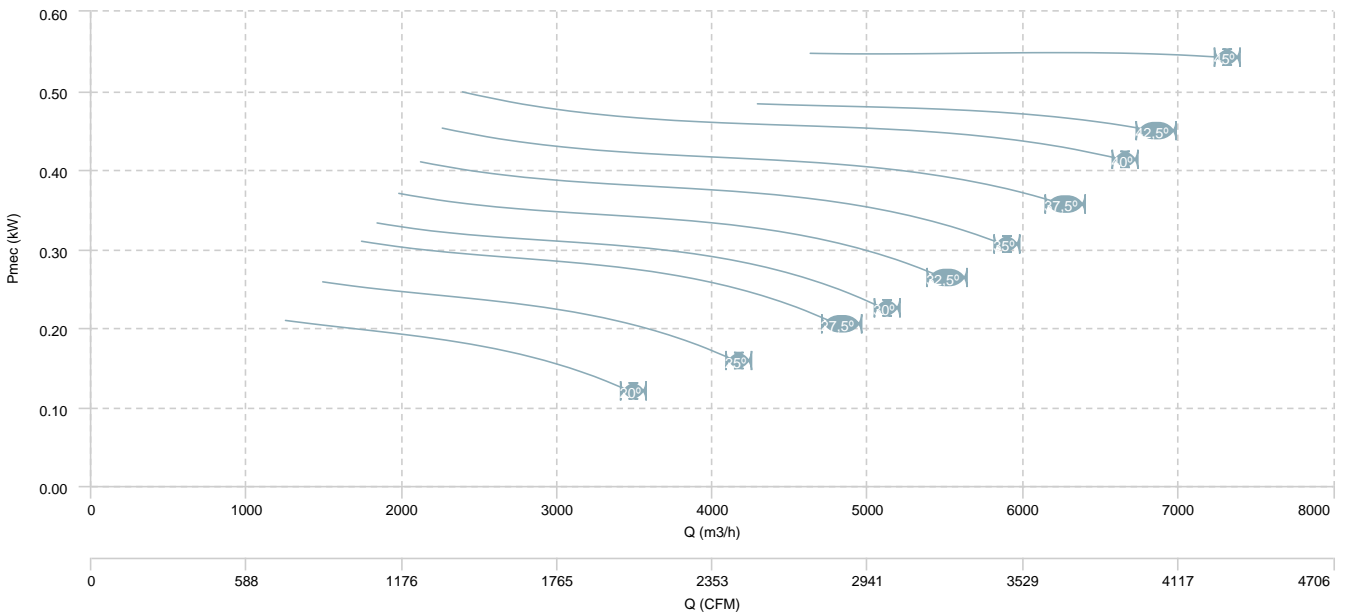

BOX HBF 45 T4/T8 (A5:6) F400

AIR FLOW - PRESSURE (8 poles)

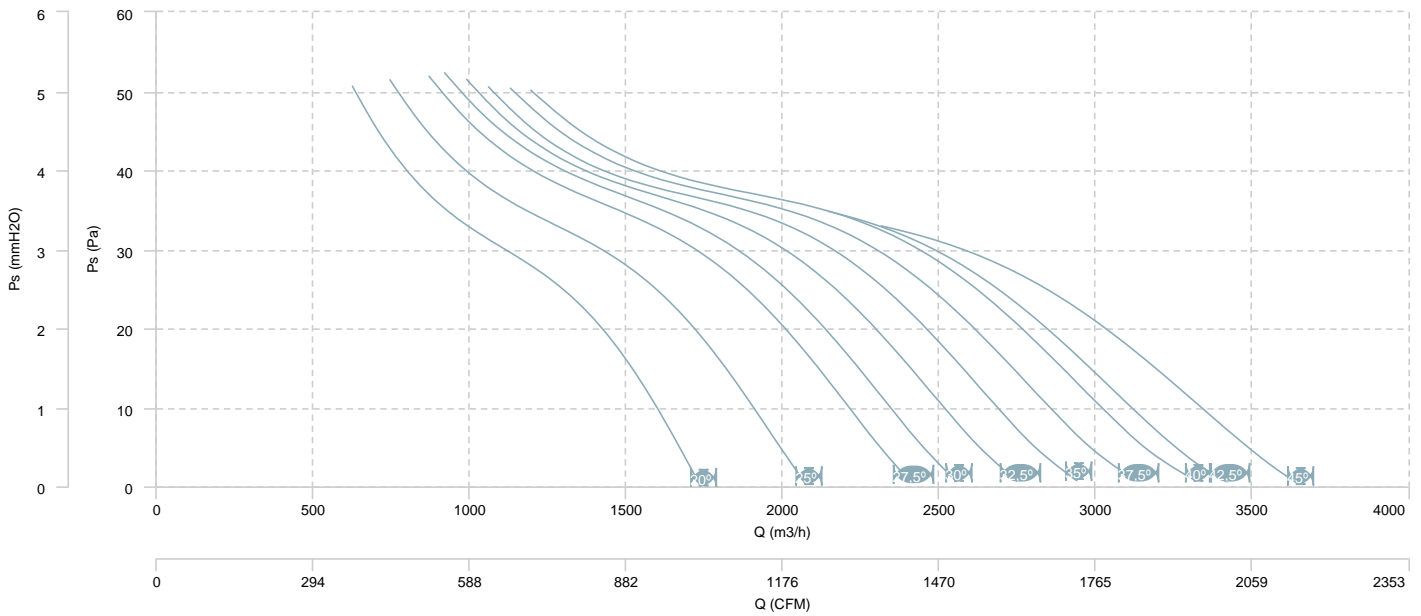

AIR FLOW - MECHANICAL POWER (8 poles)

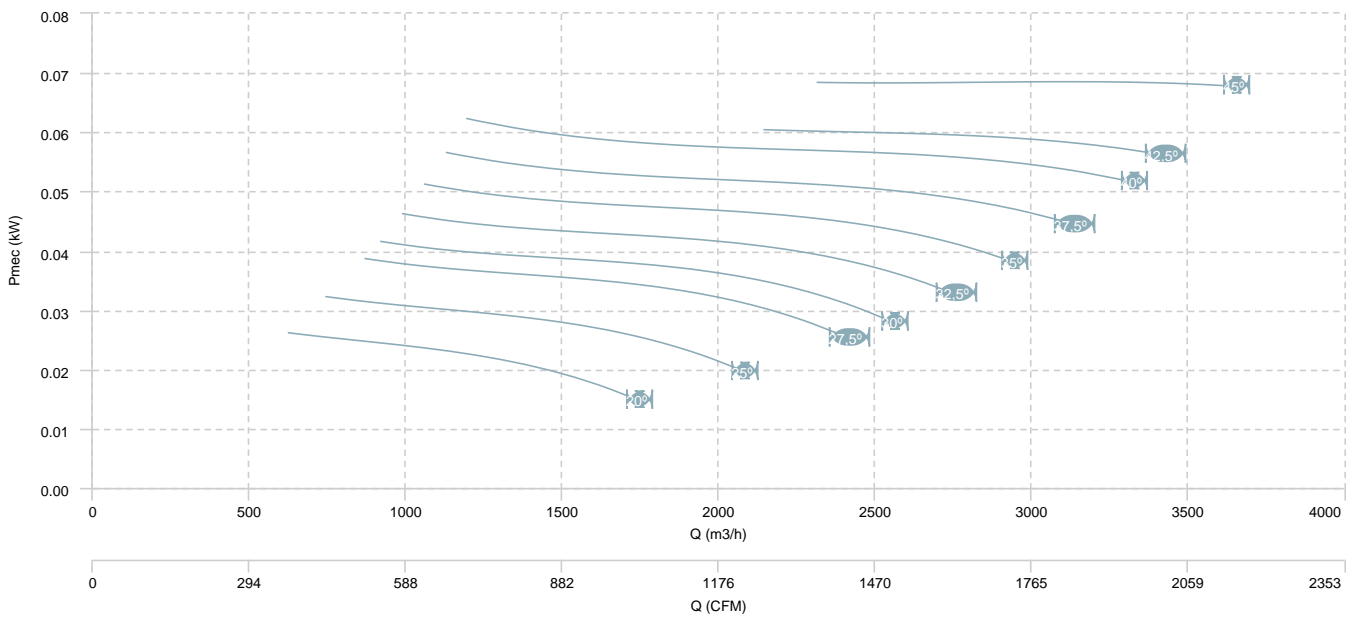

BOX HBF 50 T4 (A5:6) F400

AIR FLOW - PRESSURE

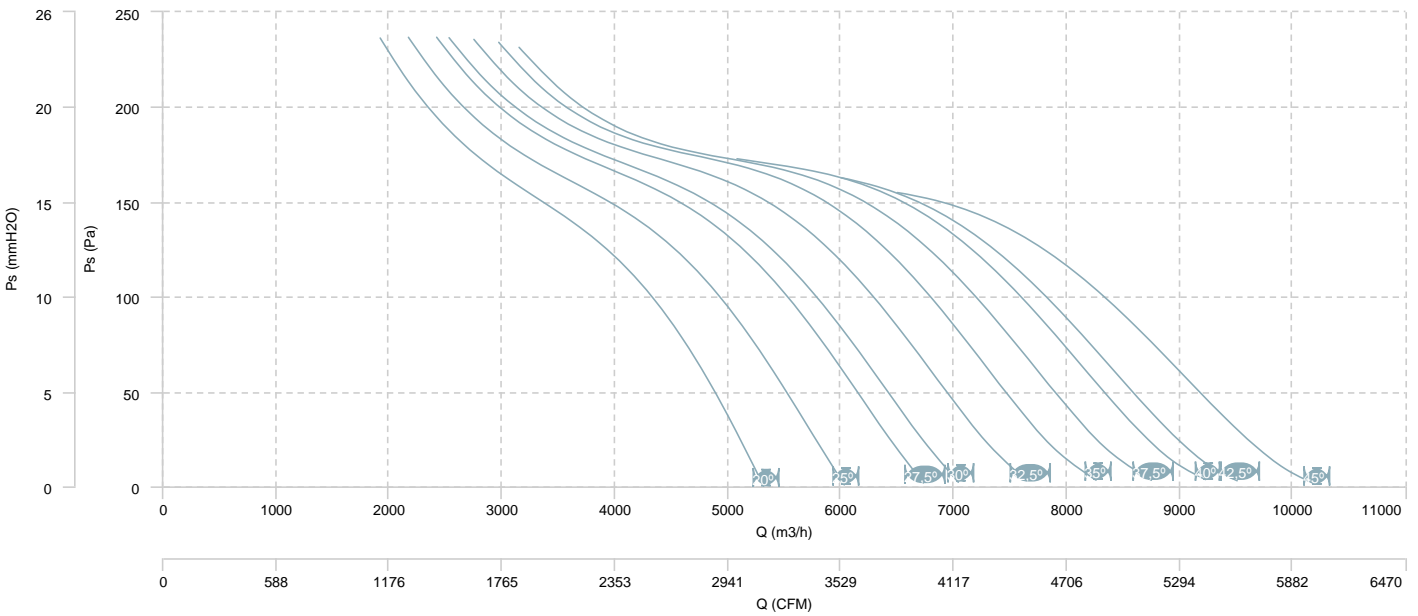

AIR FLOW - MECHANICAL POWER

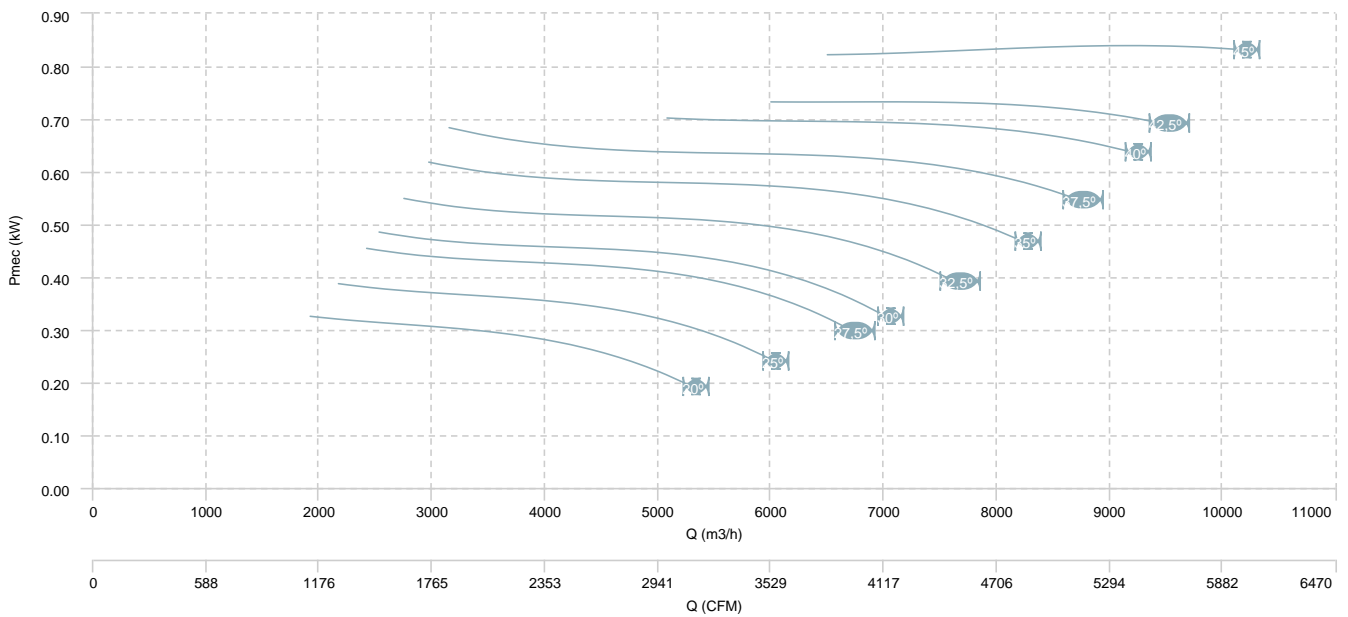

BOX HBF 50 T6 (A5:6) F400

AIR FLOW - PRESSURE

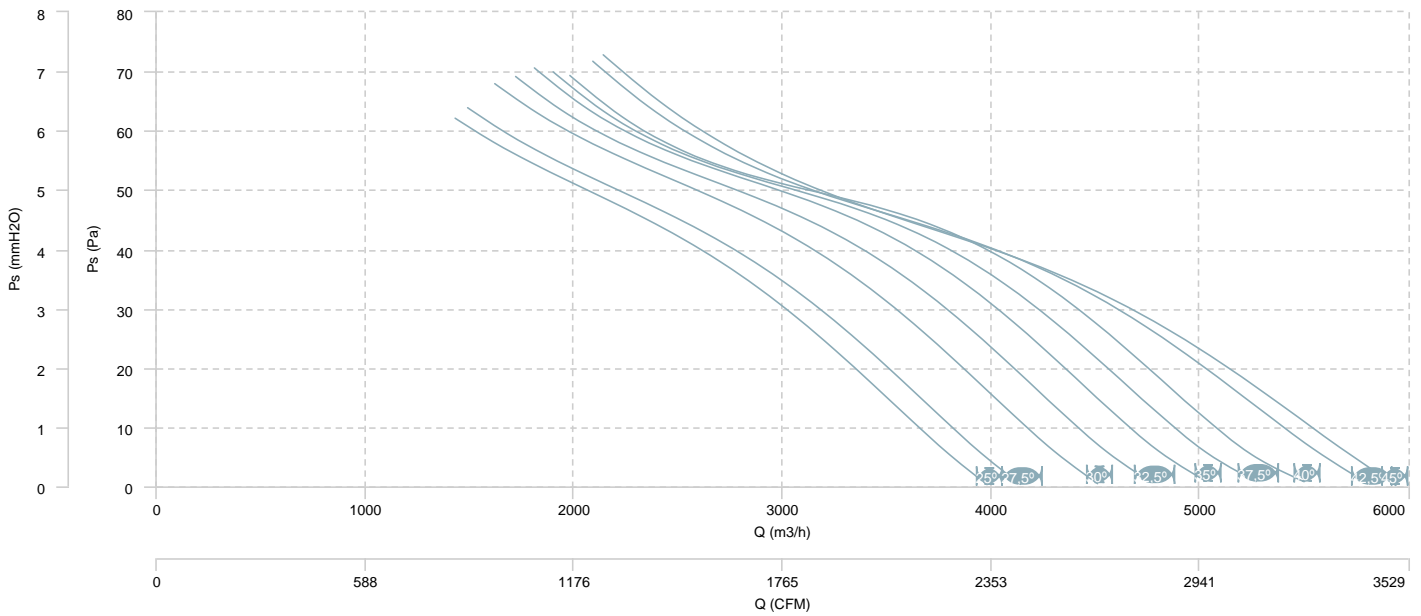

AIR FLOW - MECHANICAL POWER

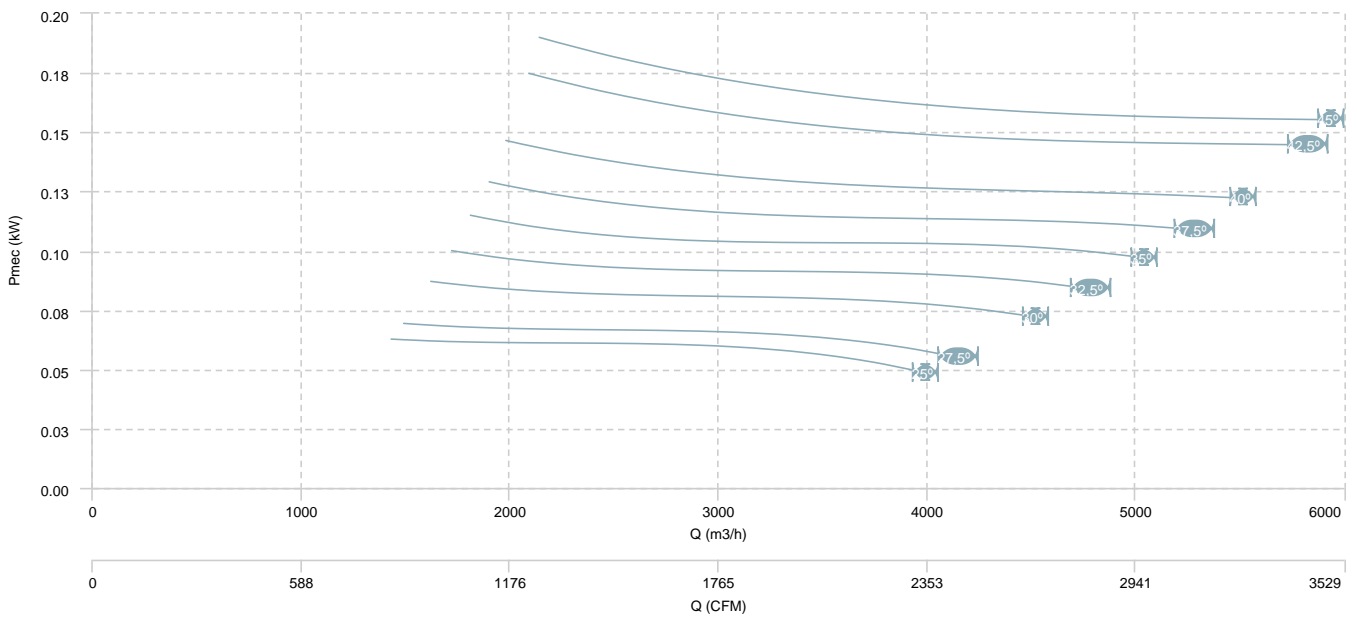

BOX HBF 50 T4/T8 (A5:6) F400

AIR FLOW - PRESSURE (4 poles)

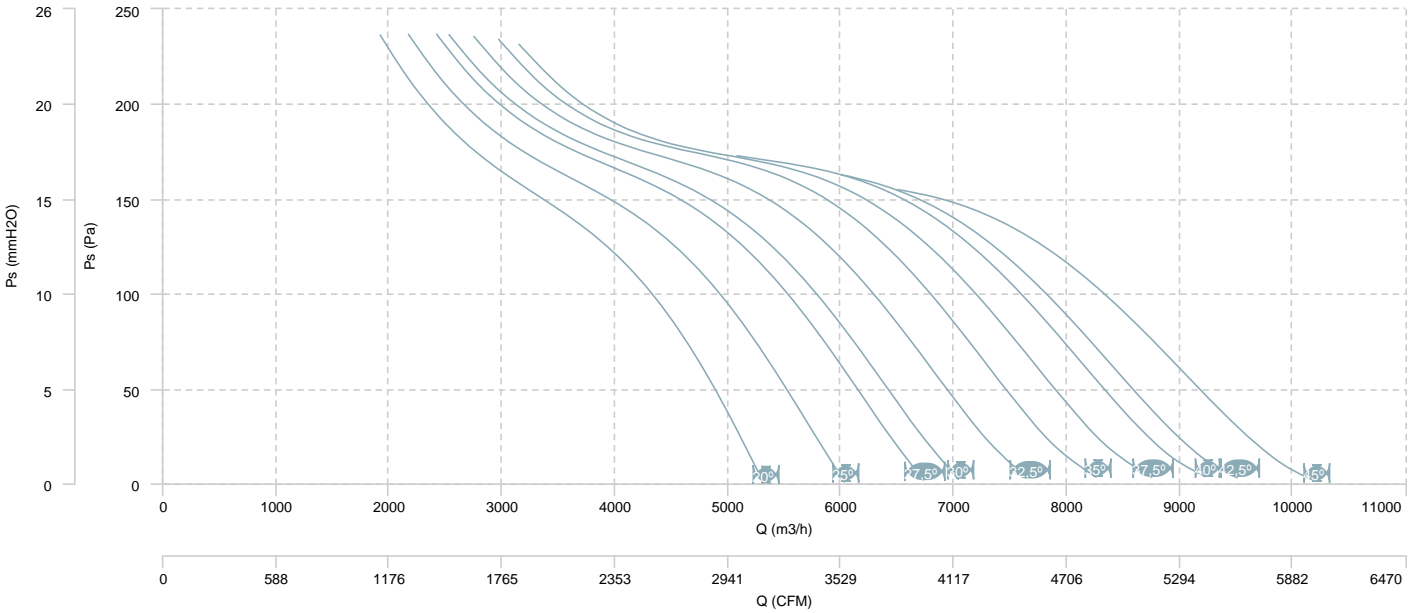

AIR FLOW - MECHANICAL POWER (4 poles)

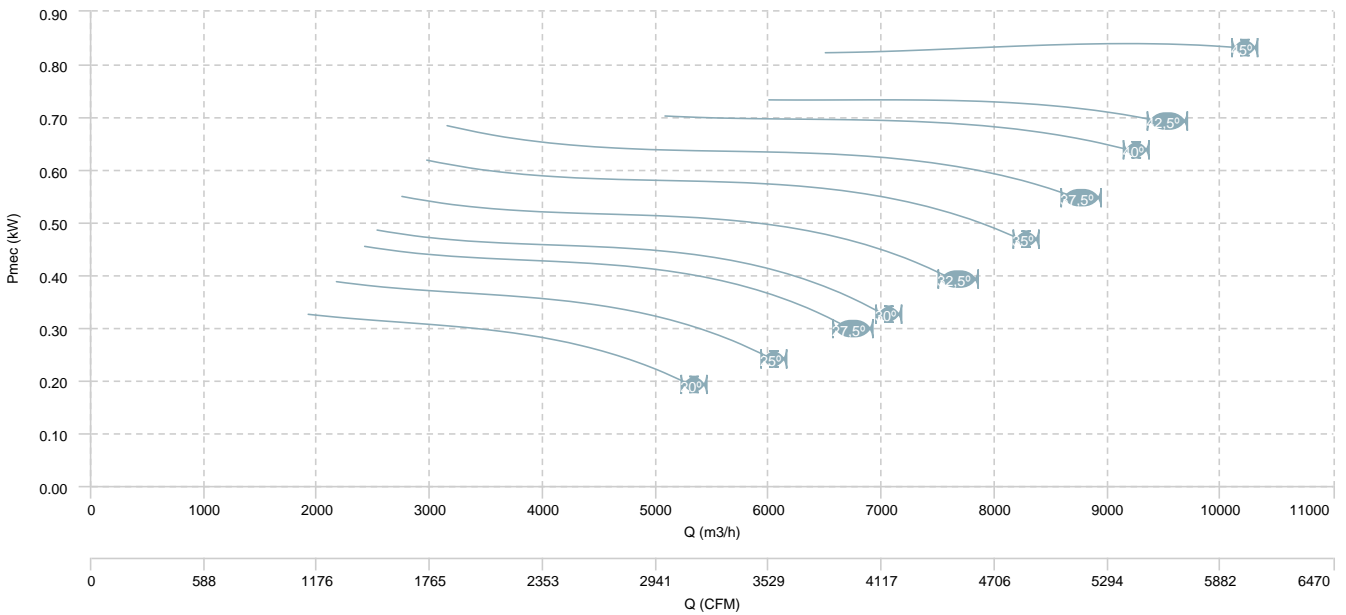

BOX HBF 50 T4/T8 (A5:6) F400

AIR FLOW - PRESSURE (8 poles)

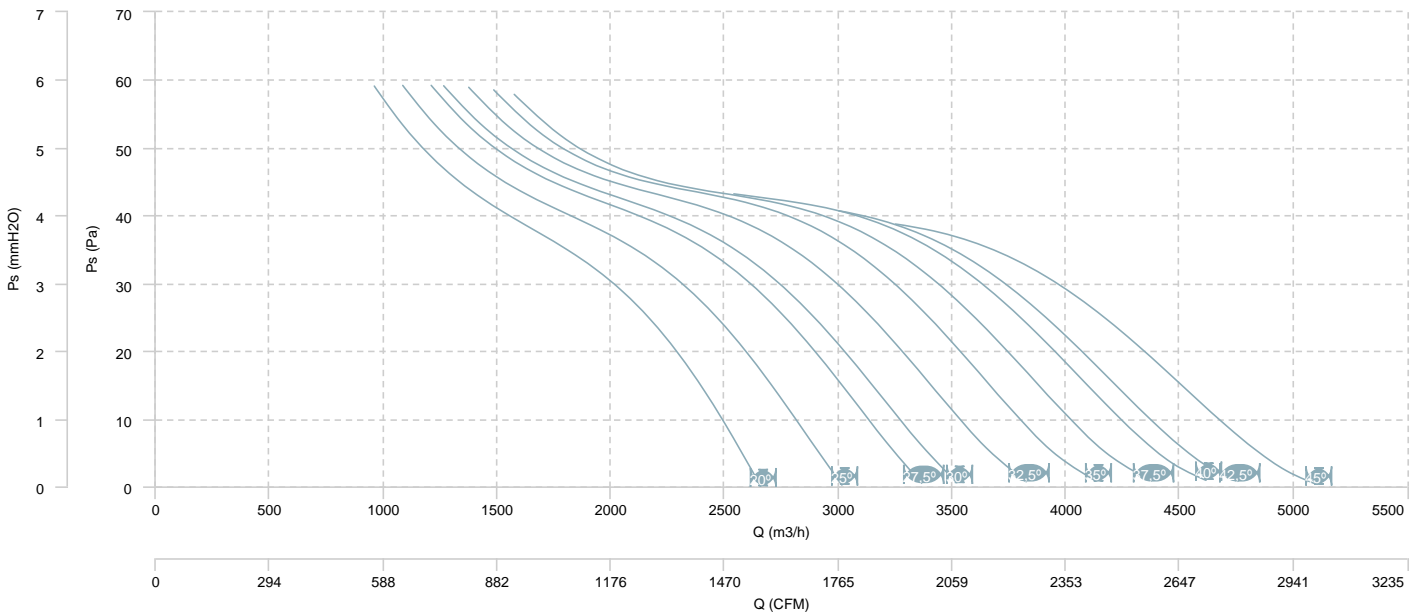

AIR FLOW - MECHANICAL POWER (8 poles)

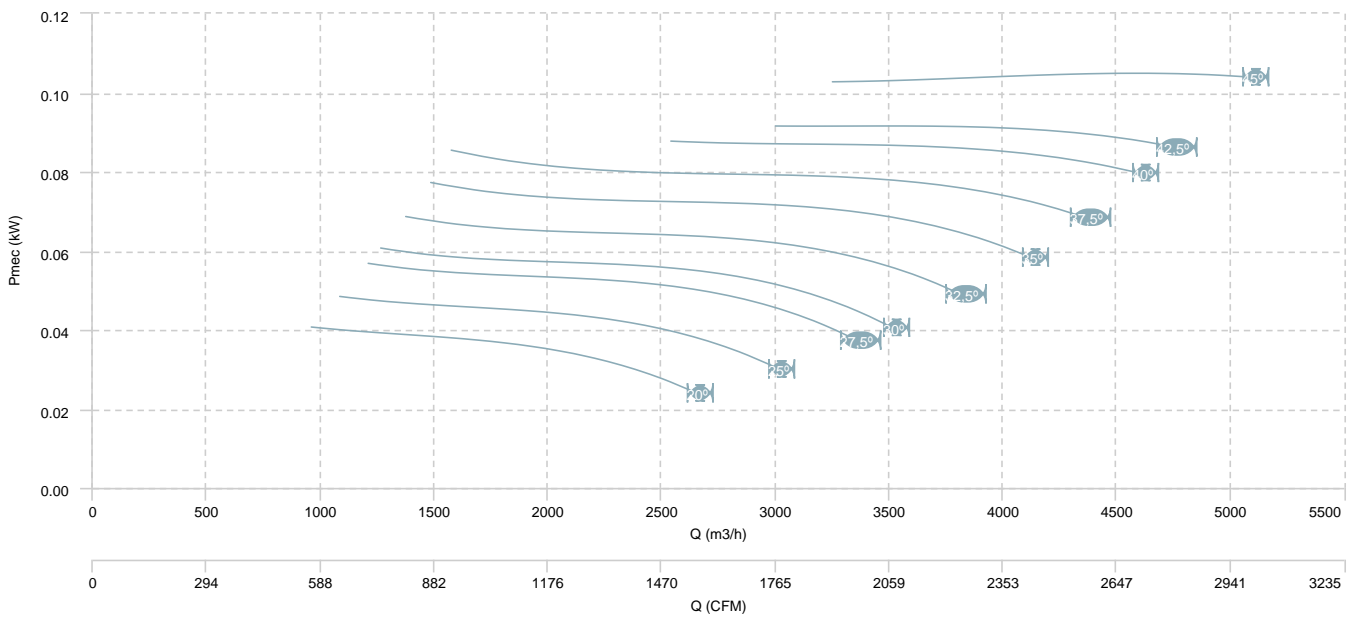

BOX HBF 56 T4 (A5:6) F400

**AIR FLOW - PRESSURE**

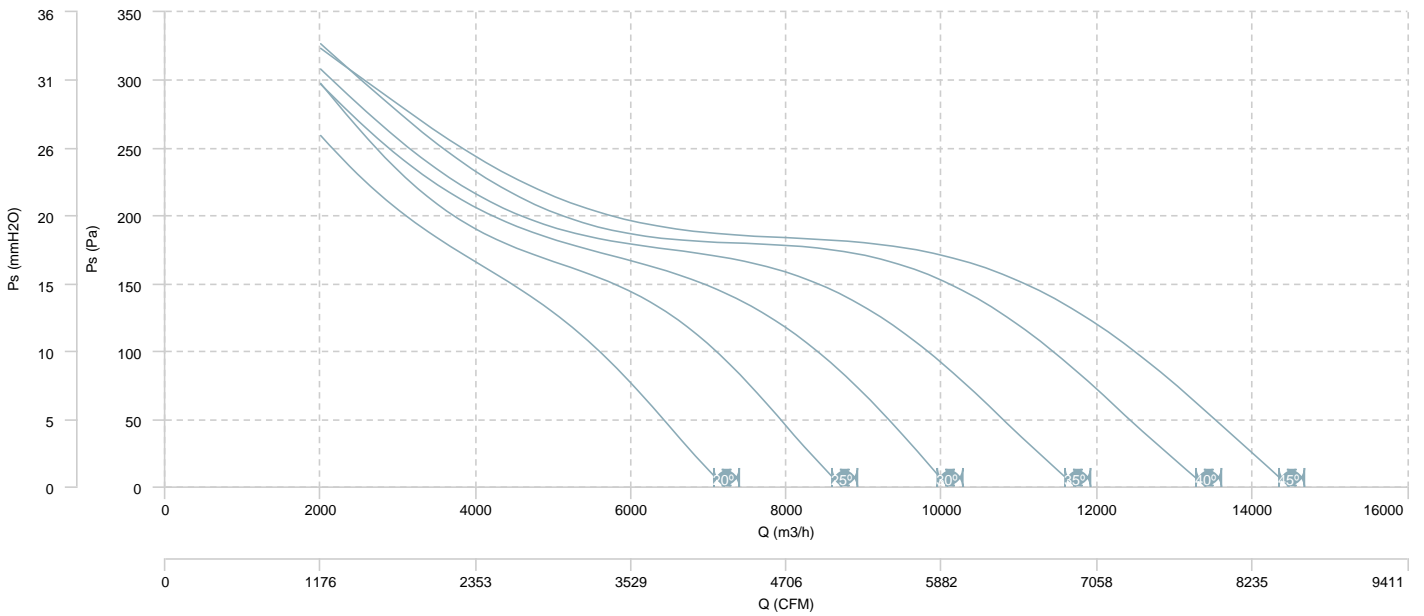

**AIR FLOW - MECHANICAL POWER**

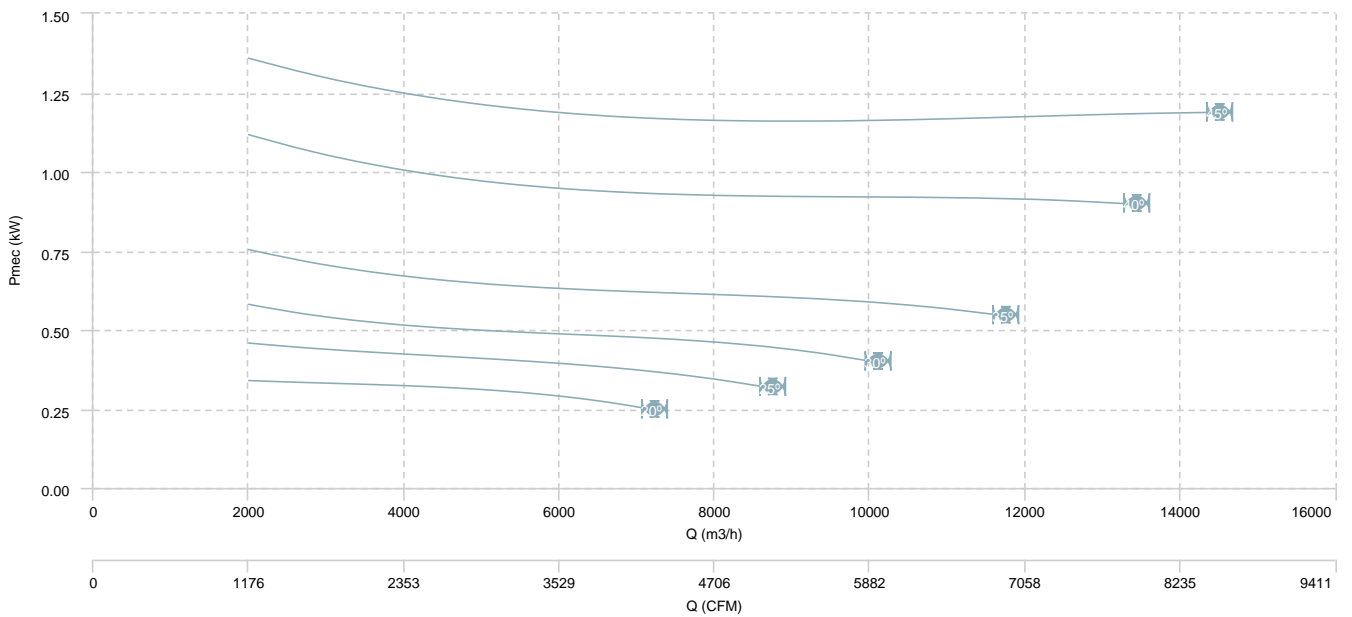



BOX HBF 56 T6 (A5:6) F400

**AIR FLOW - PRESSURE**

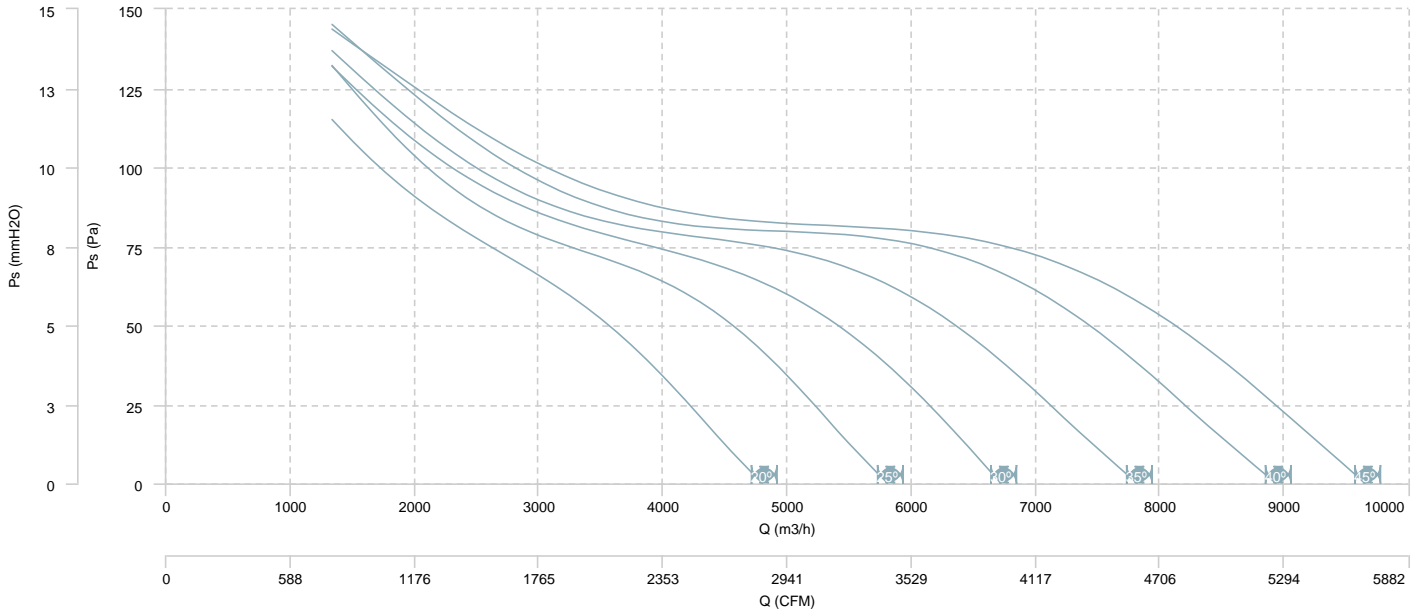

**AIR FLOW - MECHANICAL POWER**

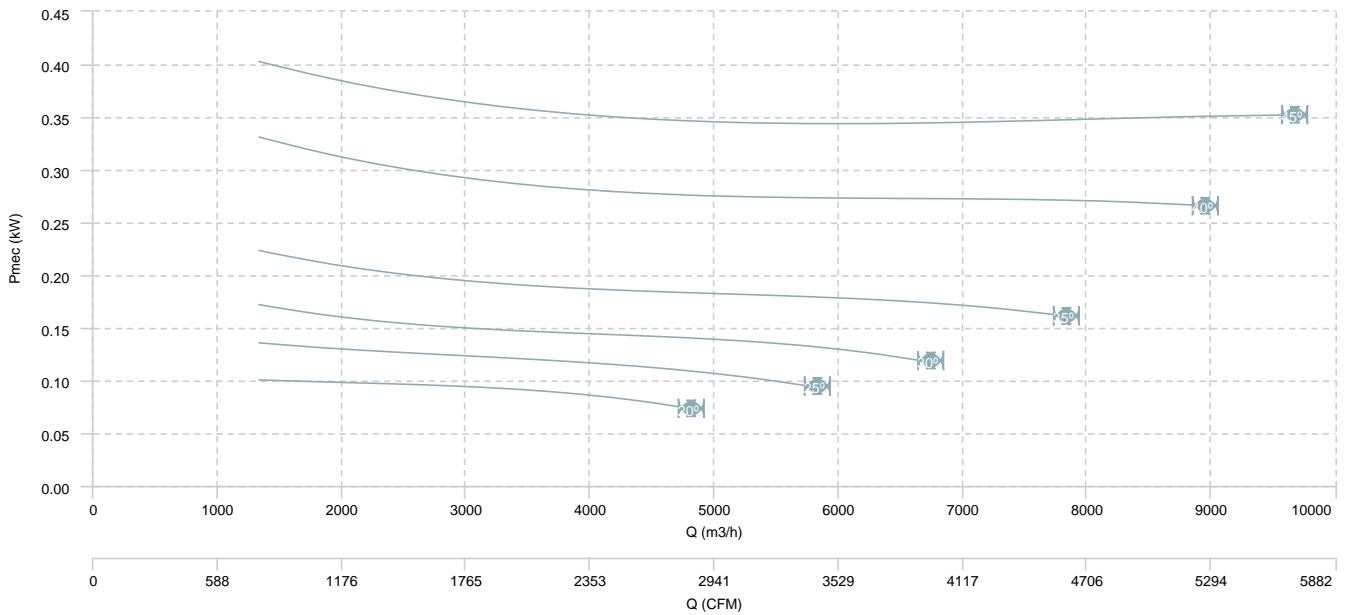

BOX HBF 56 T4/T8 (A5:6) F400

AIR FLOW - PRESSURE (4 poles)

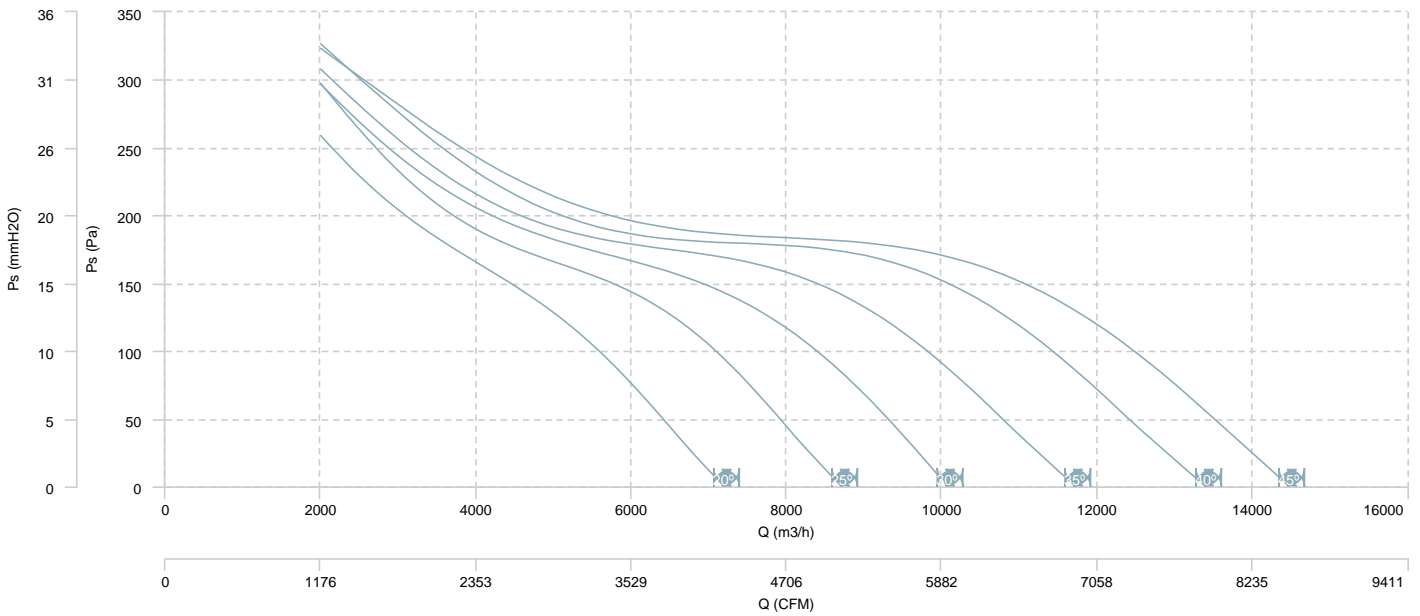

AIR FLOW - MECHANICAL POWER (4 poles)

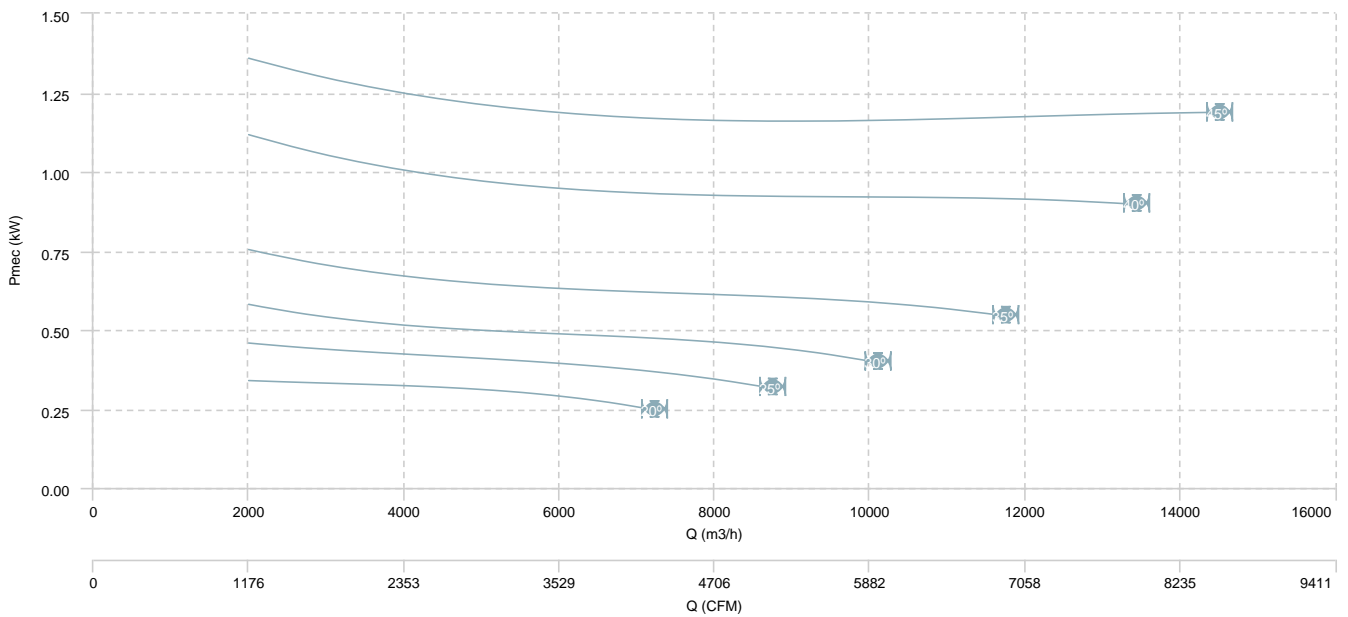

BOX HBF 56 T4/T8 (A5:6) F400

AIR FLOW - PRESSURE (8 poles)

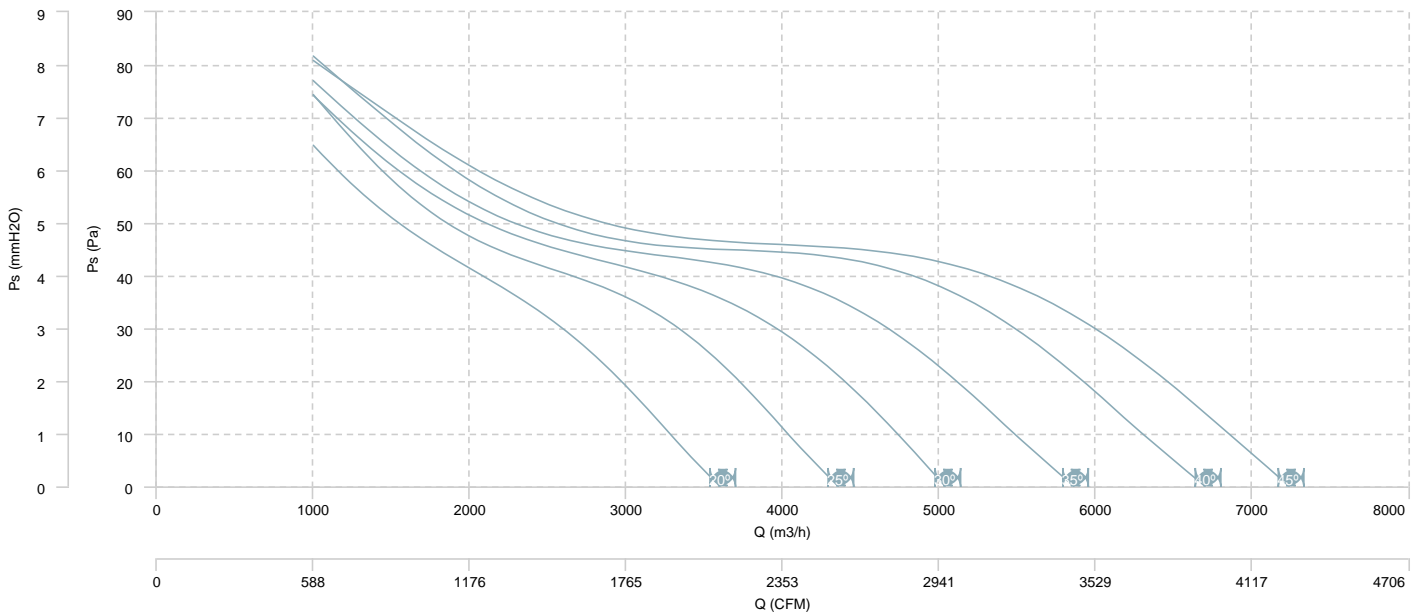

AIR FLOW - MECHANICAL POWER (8 poles)

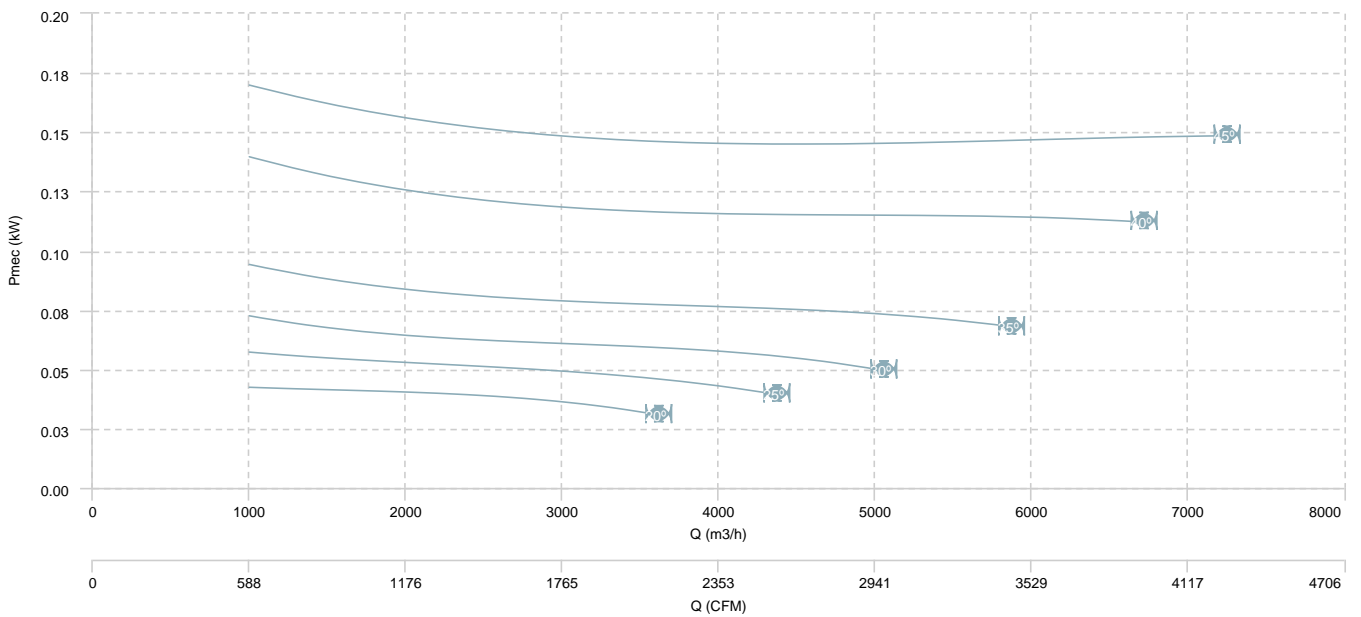

BOX HBF 63 T4 (A5:6) F400

AIR FLOW - PRESSURE

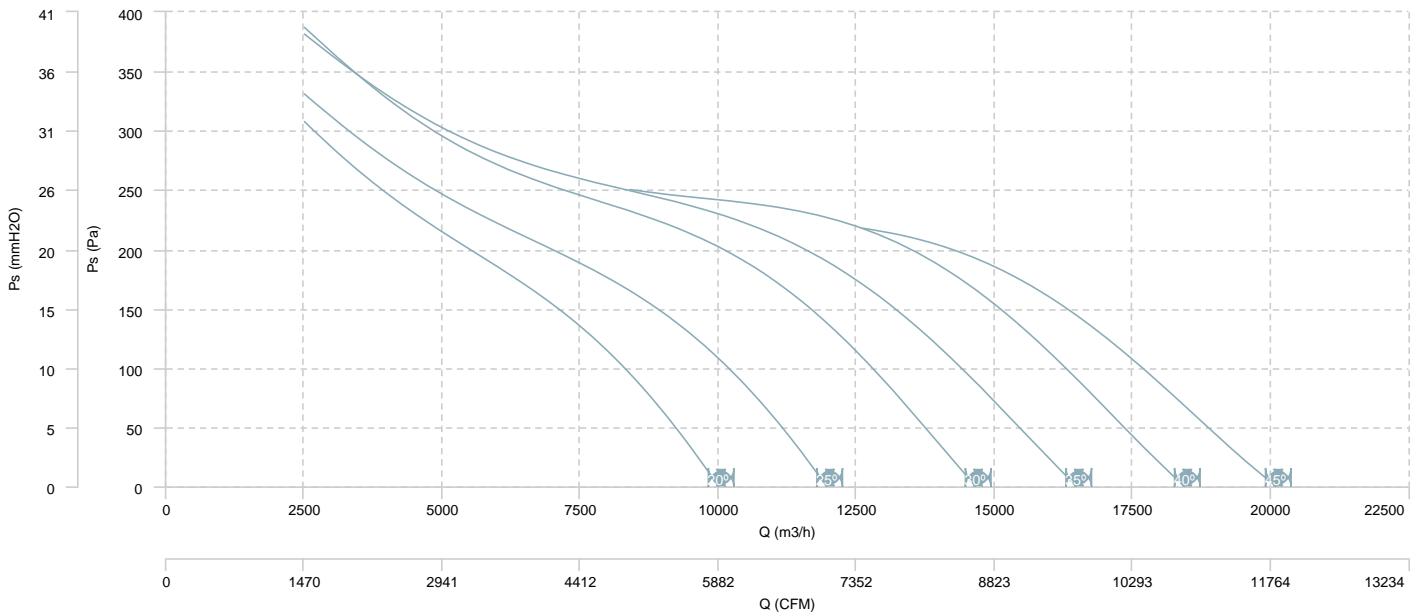

AIR FLOW - MECHANICAL POWER

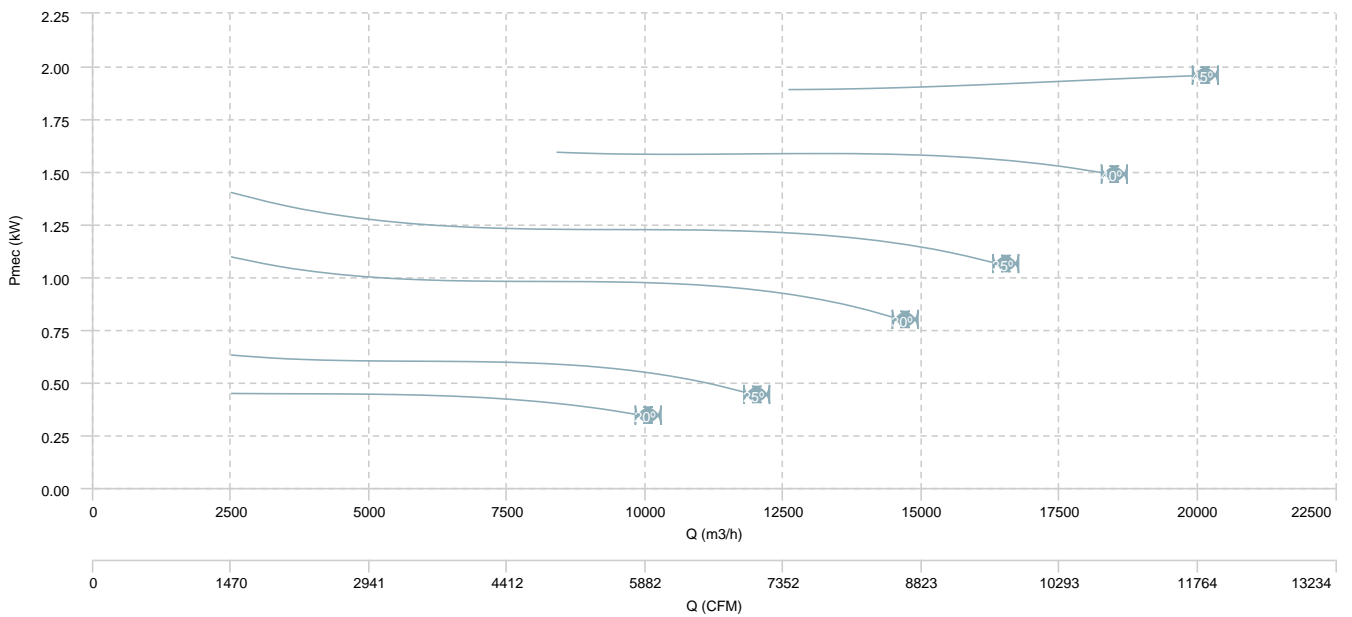

BOX HBF 63 T6 (A5:6) F400

**AIR FLOW - PRESSURE**

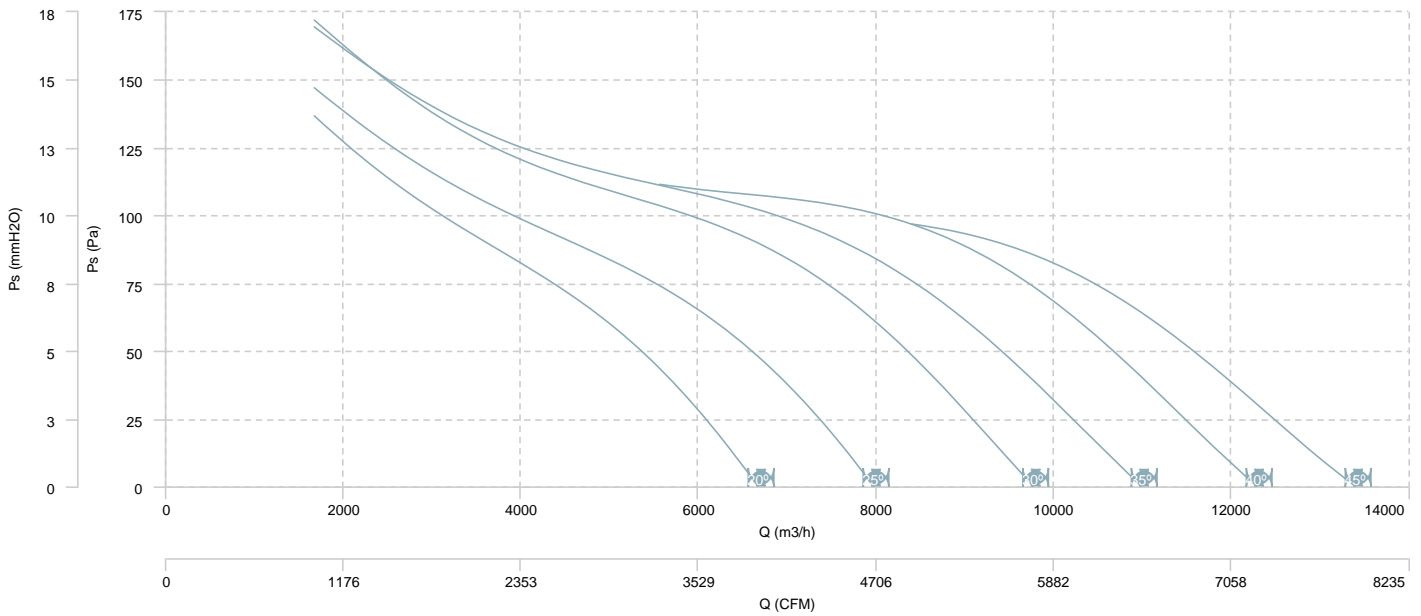

**AIR FLOW - MECHANICAL POWER**

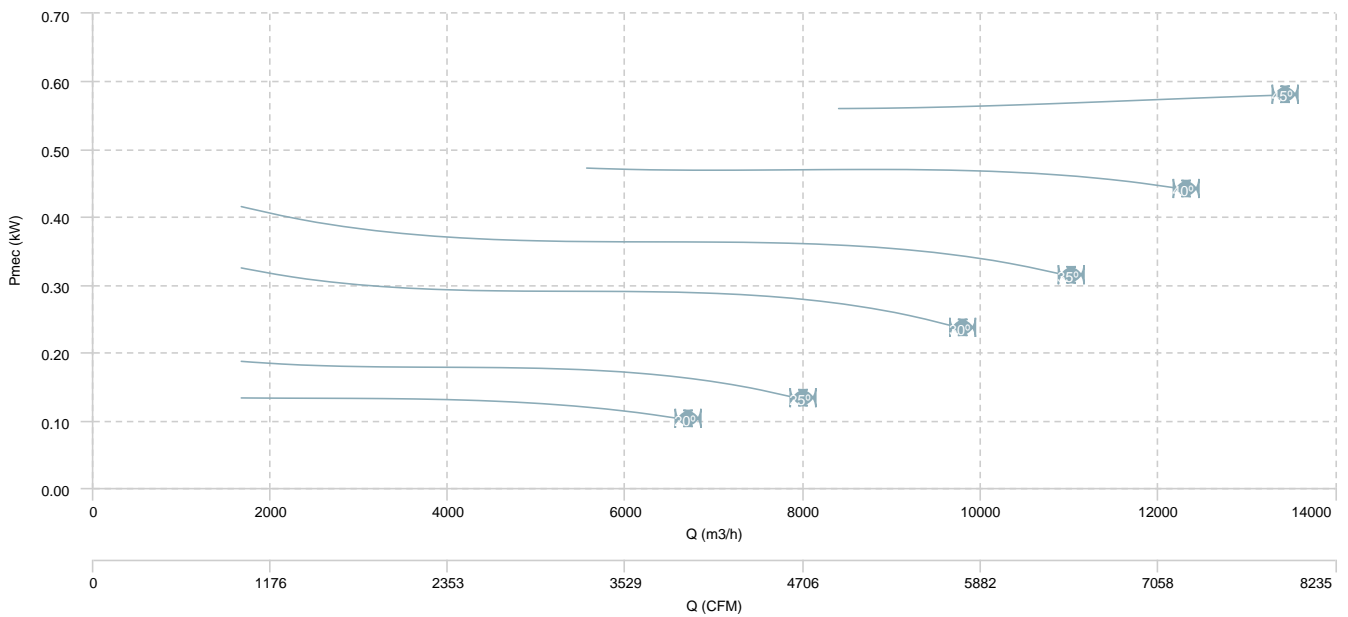

BOX HBF 63 T4/T8 (A5:6) F400

AIR FLOW - PRESSURE (4 poles)

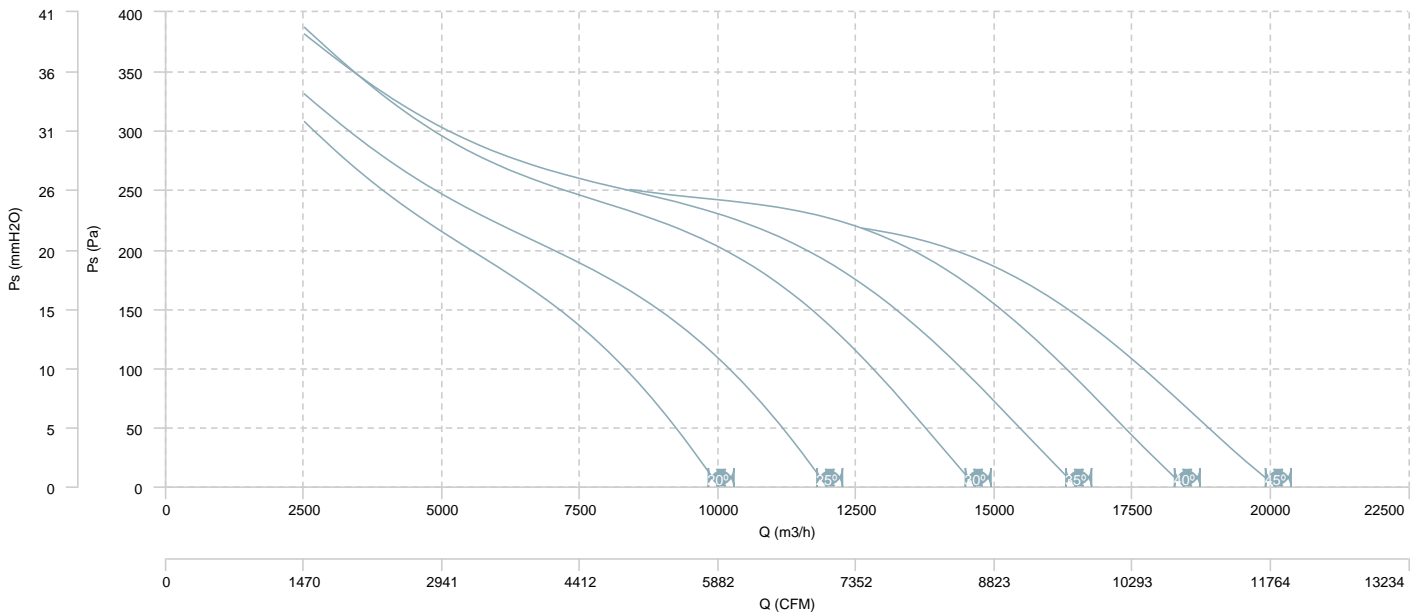

AIR FLOW - MECHANICAL POWER (4 poles)

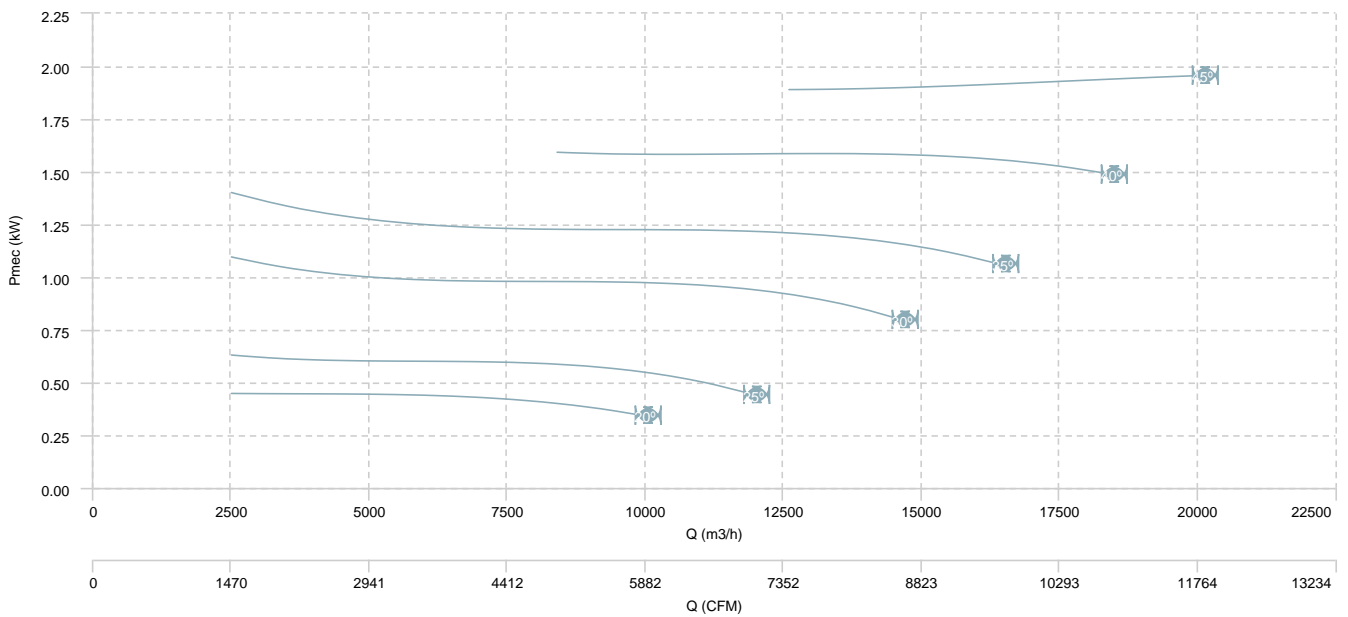

BOX HBF 63 T4/T8 (A5:6) F400

AIR FLOW - PRESSURE (8 poles)

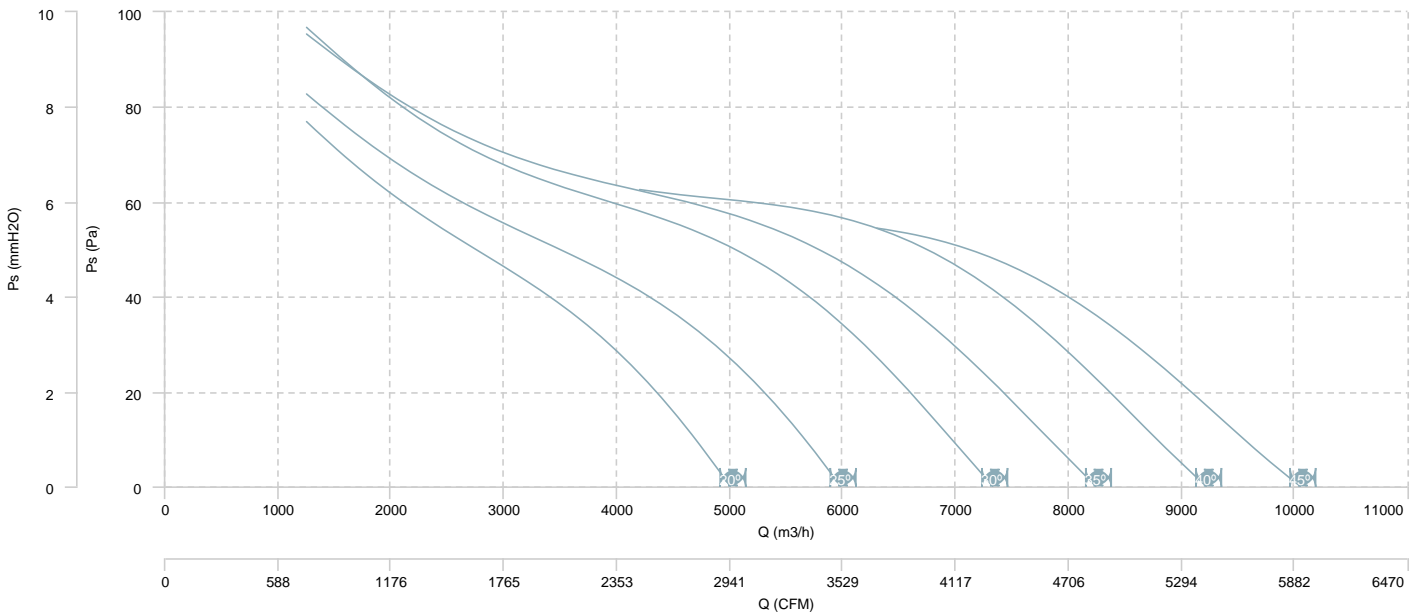

AIR FLOW - MECHANICAL POWER (8 poles)

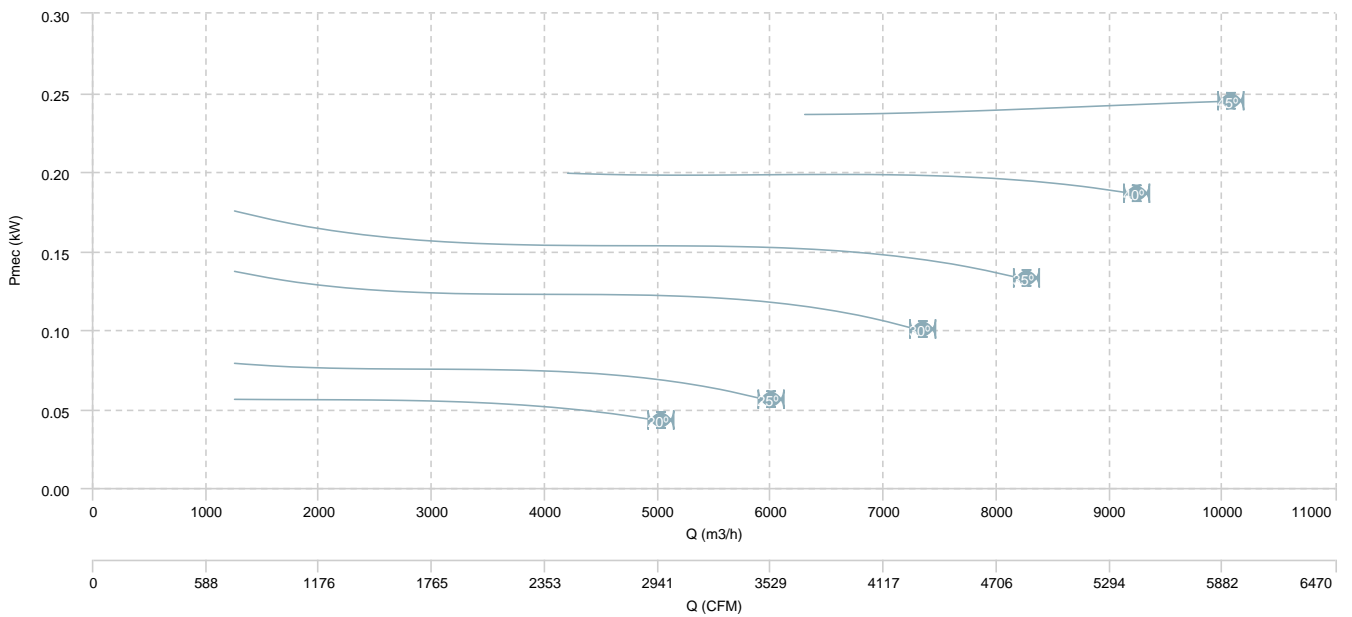

BOX HBF 71 T4 (A5:6) F400

AIR FLOW - PRESSURE

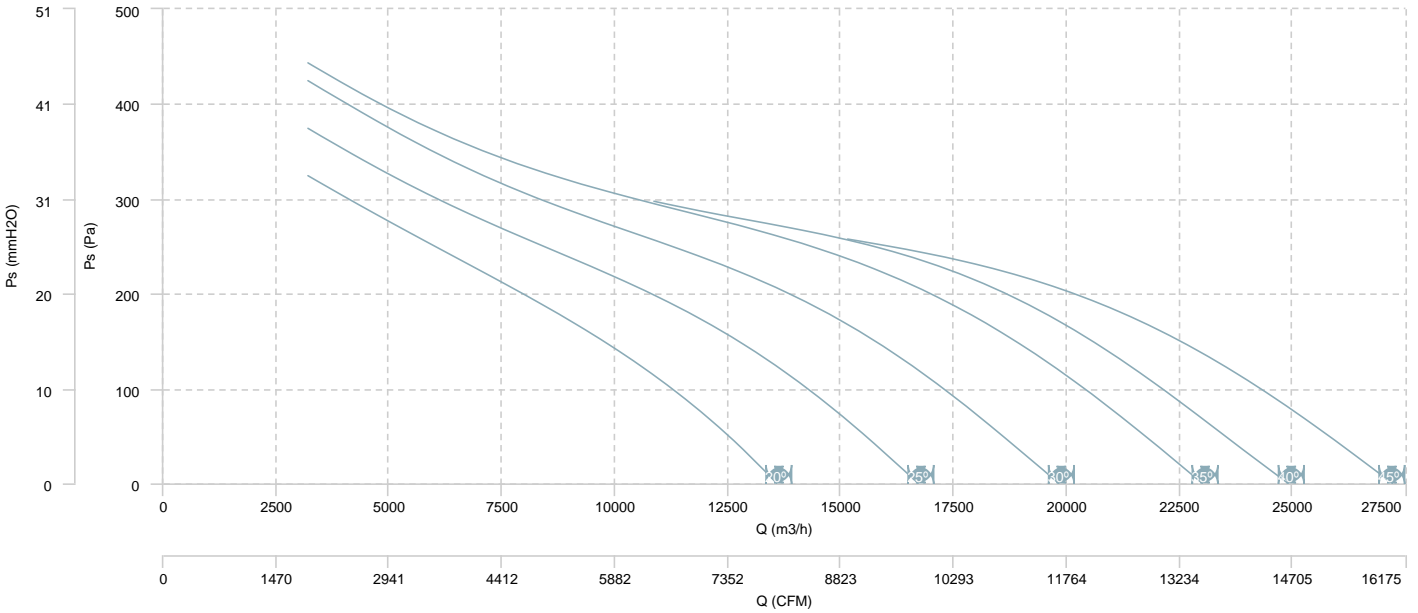

AIR FLOW - MECHANICAL POWER

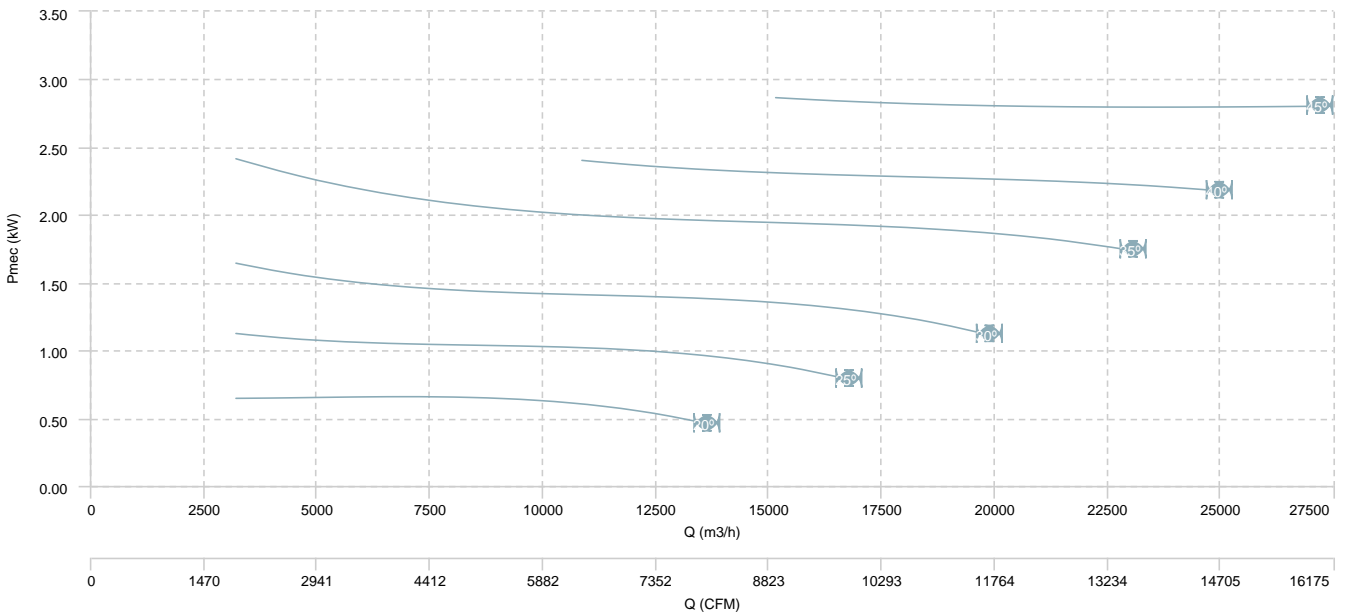



BOX HBF 71 T6 (A5:6) F400

AIR FLOW - PRESSURE

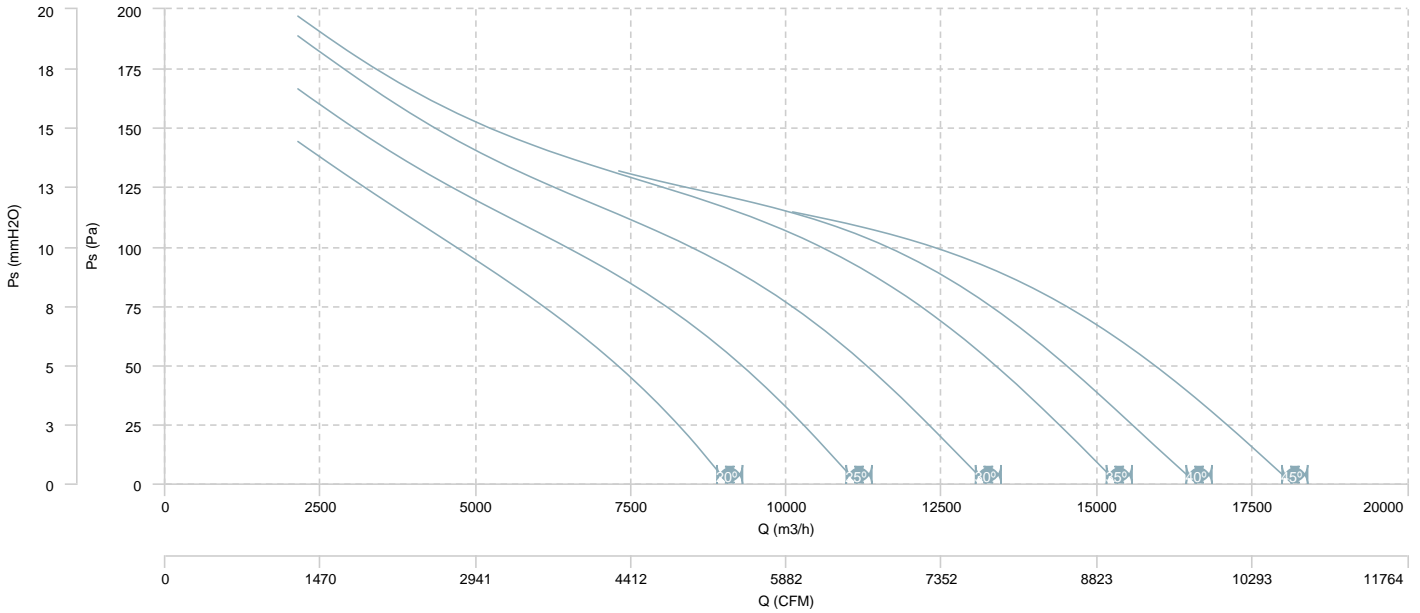

AIR FLOW - MECHANICAL POWER

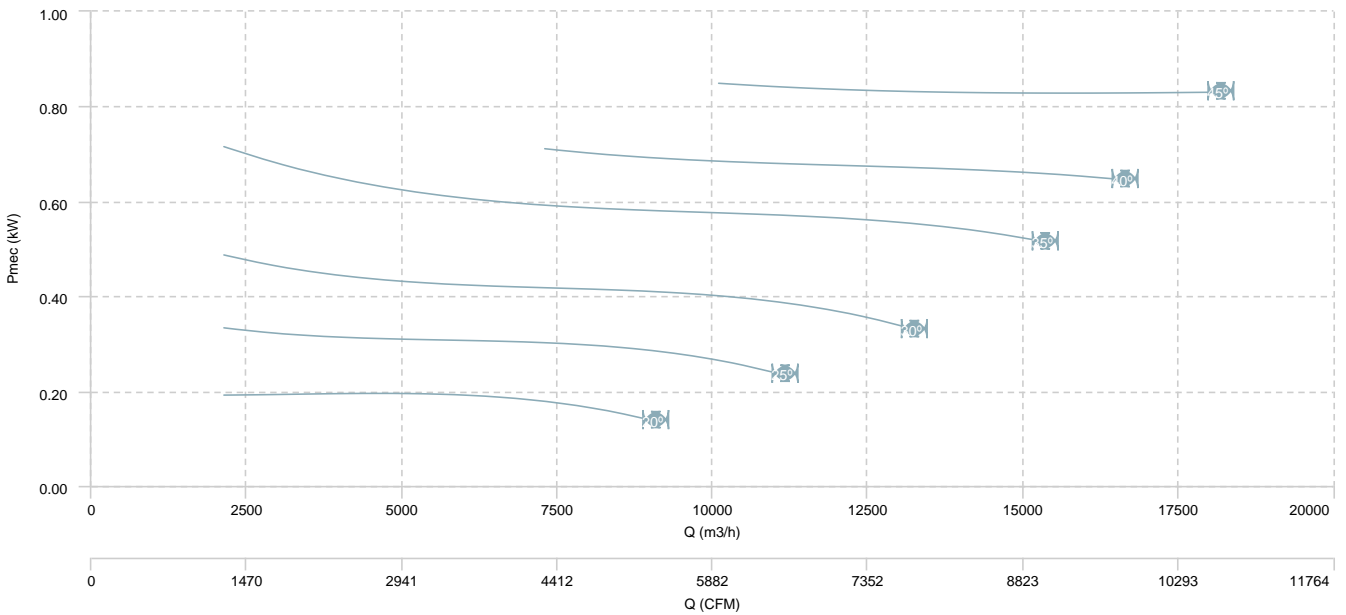

BOX HBF 71 T4/T8 (A5:6) F400

AIR FLOW - PRESSURE (4 poles)

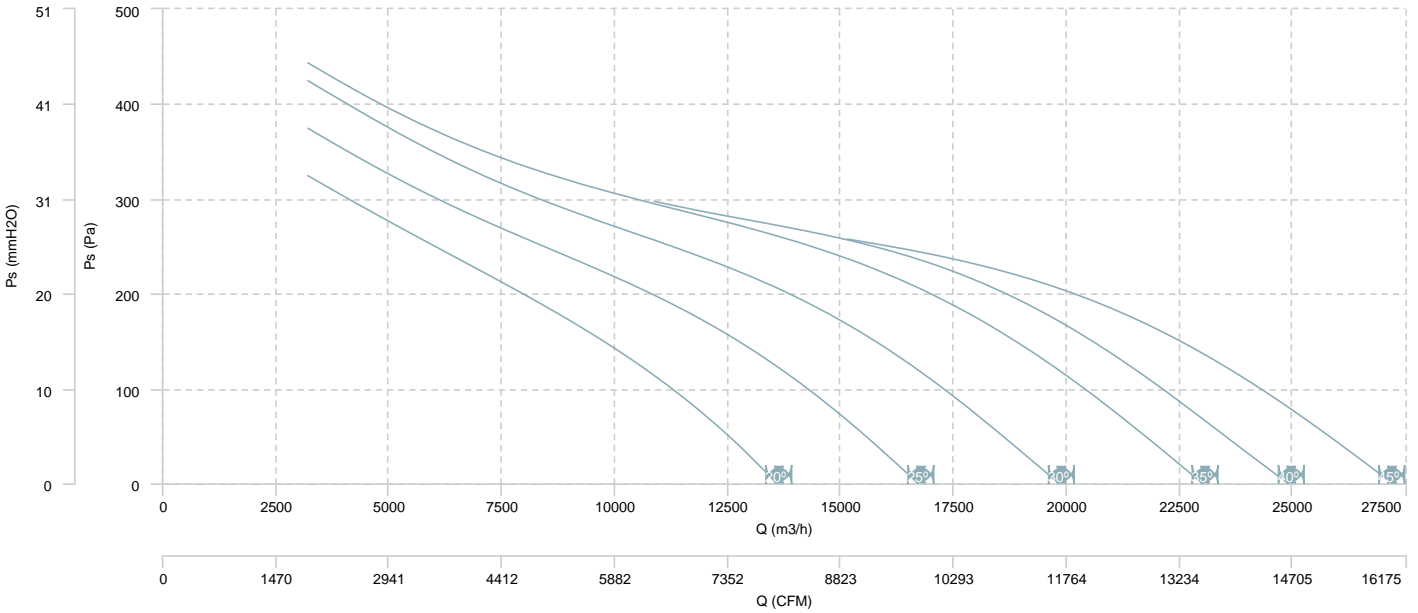

AIR FLOW - MECHANICAL POWER (4 poles)

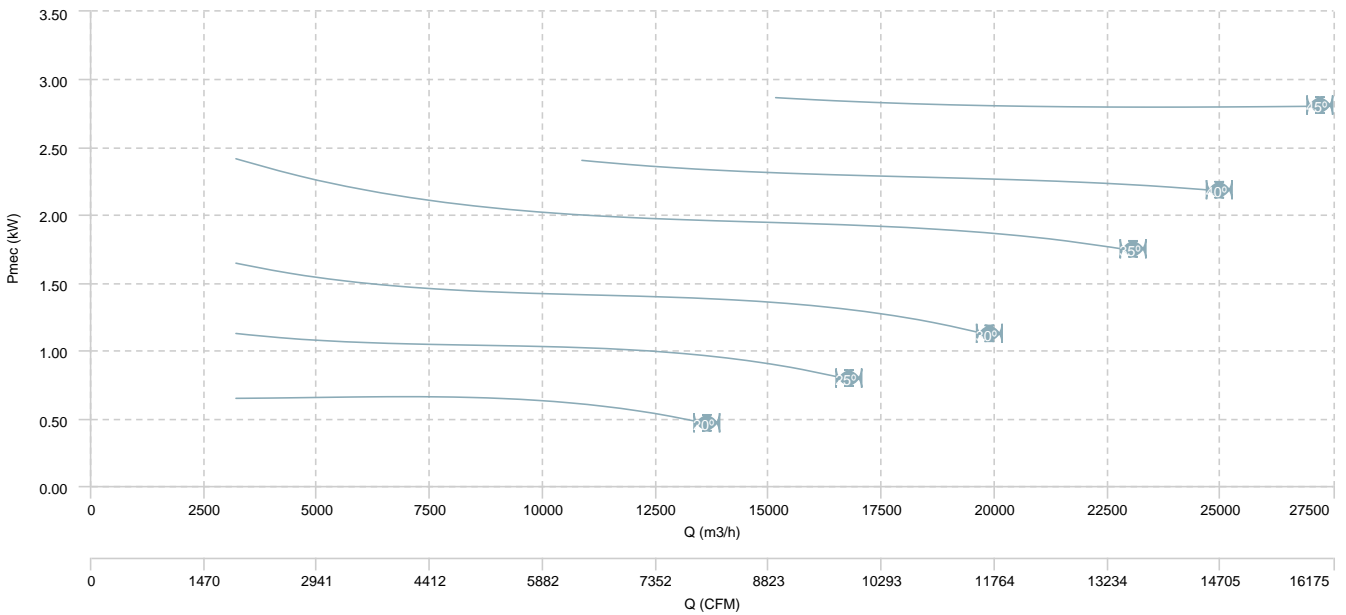

BOX HBF 71 T4/T8 (A5:6) F400

AIR FLOW - PRESSURE (8 poles)

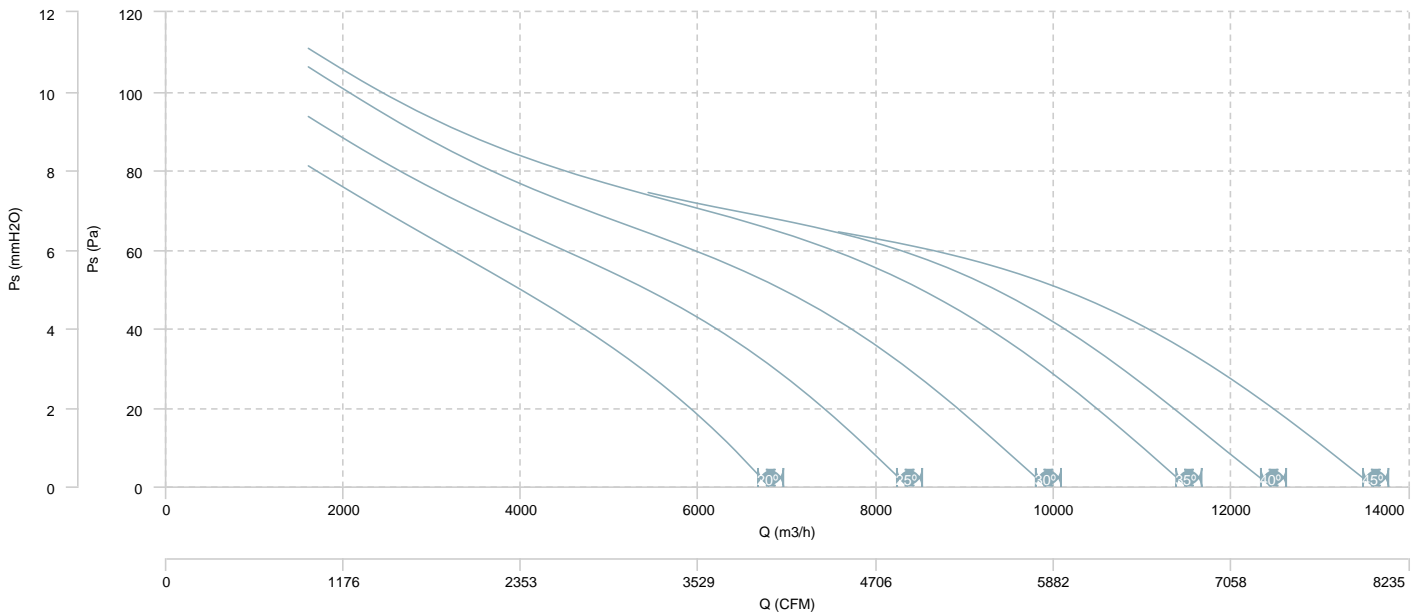

AIR FLOW - MECHANICAL POWER (8 poles)

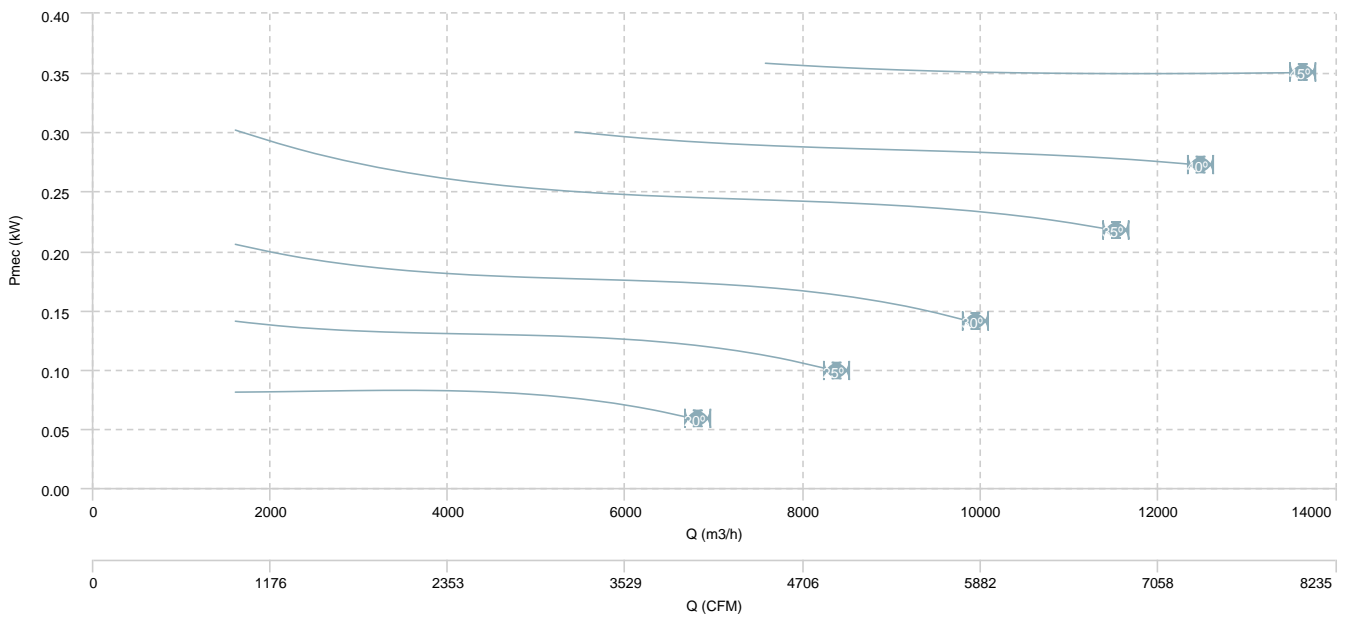

BOX HBF 80 T4 (A5:6) F400

AIR FLOW - PRESSURE

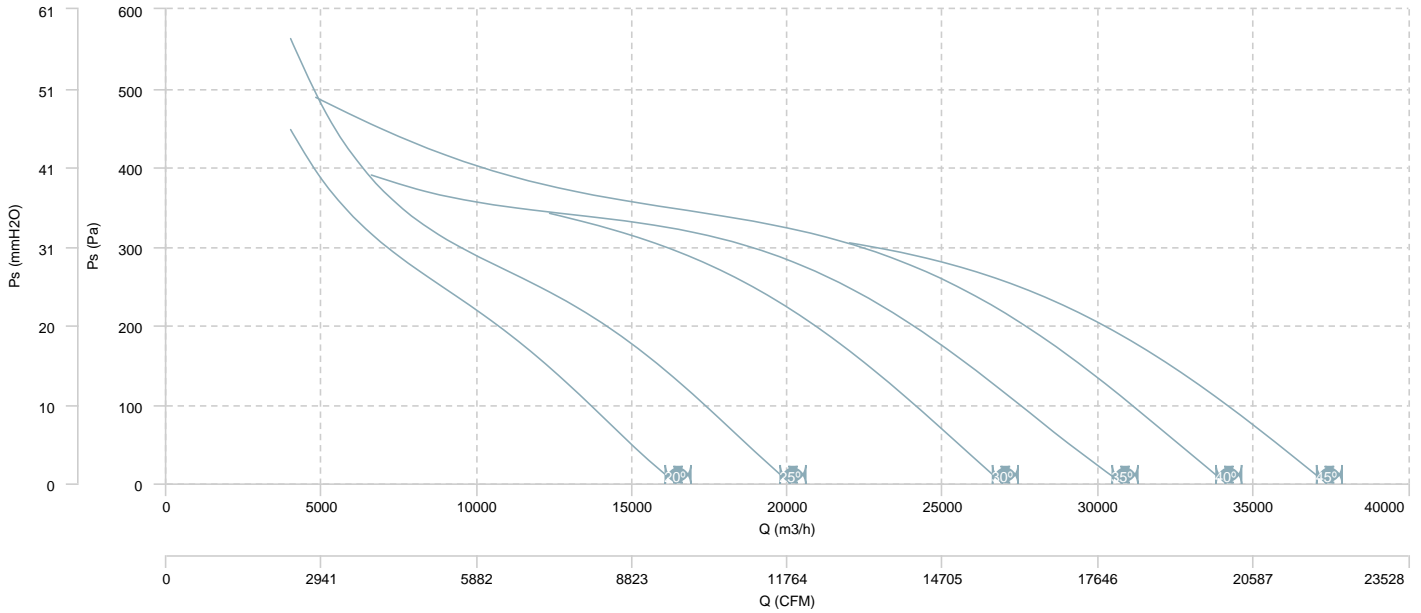

AIR FLOW - MECHANICAL POWER

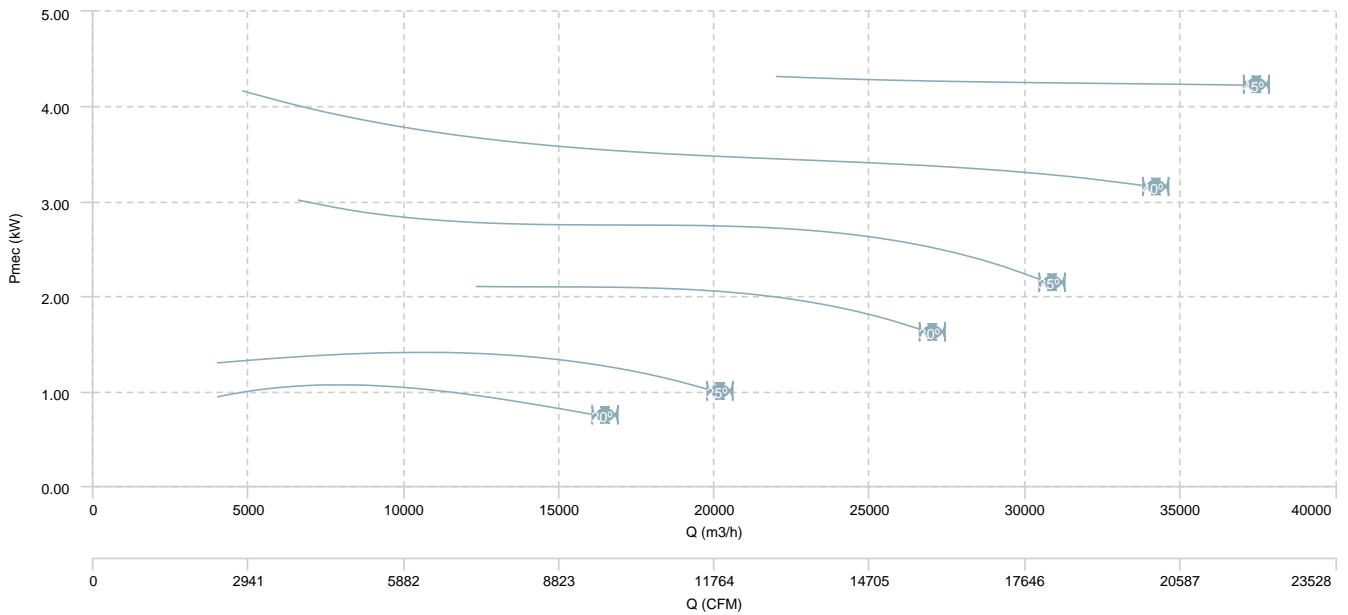

BOX HBF 80 T6 (A5:6) F400

AIR FLOW - PRESSURE

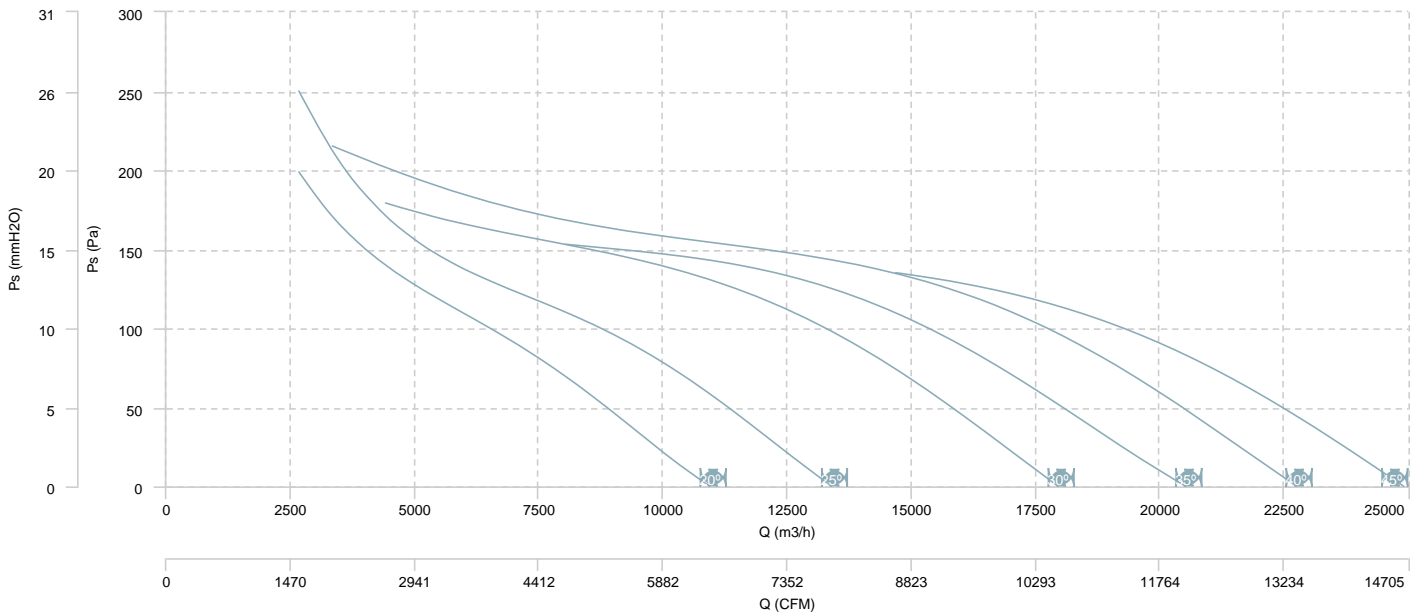

AIR FLOW - MECHANICAL POWER

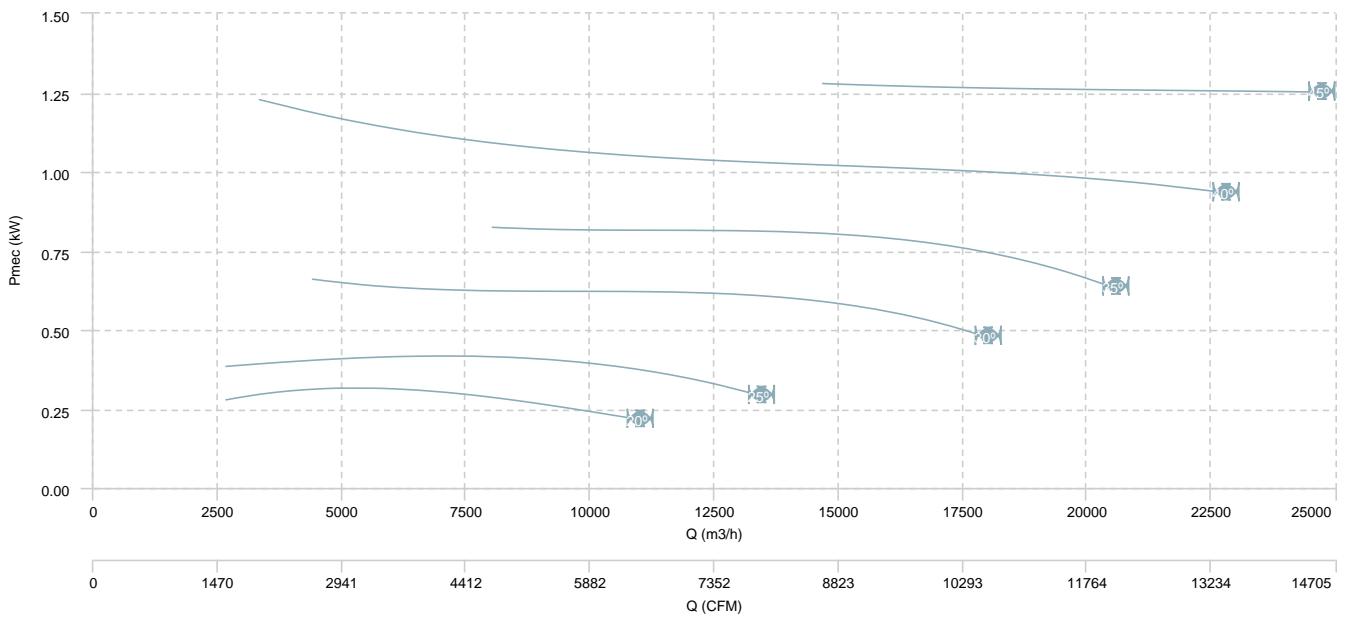

BOX HBF 80 T4/T8 (A5:6) F400

AIR FLOW - PRESSURE (4 poles)

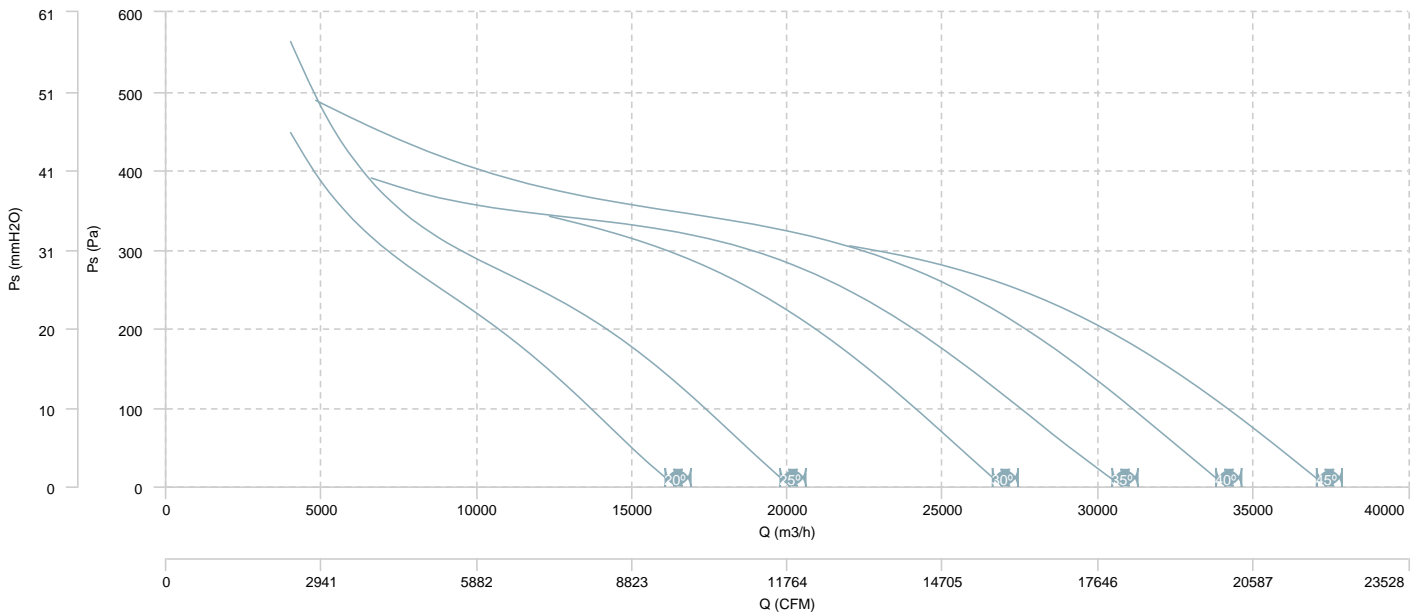

AIR FLOW - MECHANICAL POWER (4 poles)

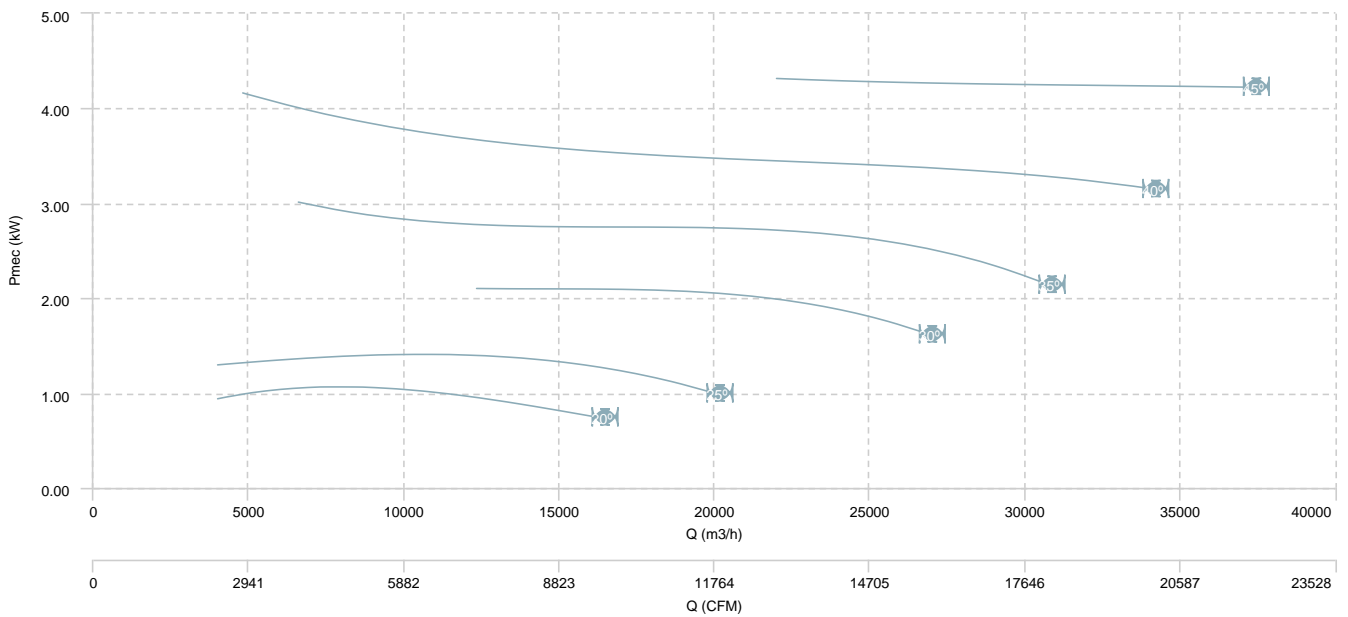

BOX HBF 80 T4/T8 (A5:6) F400

AIR FLOW - PRESSURE (8 poles)

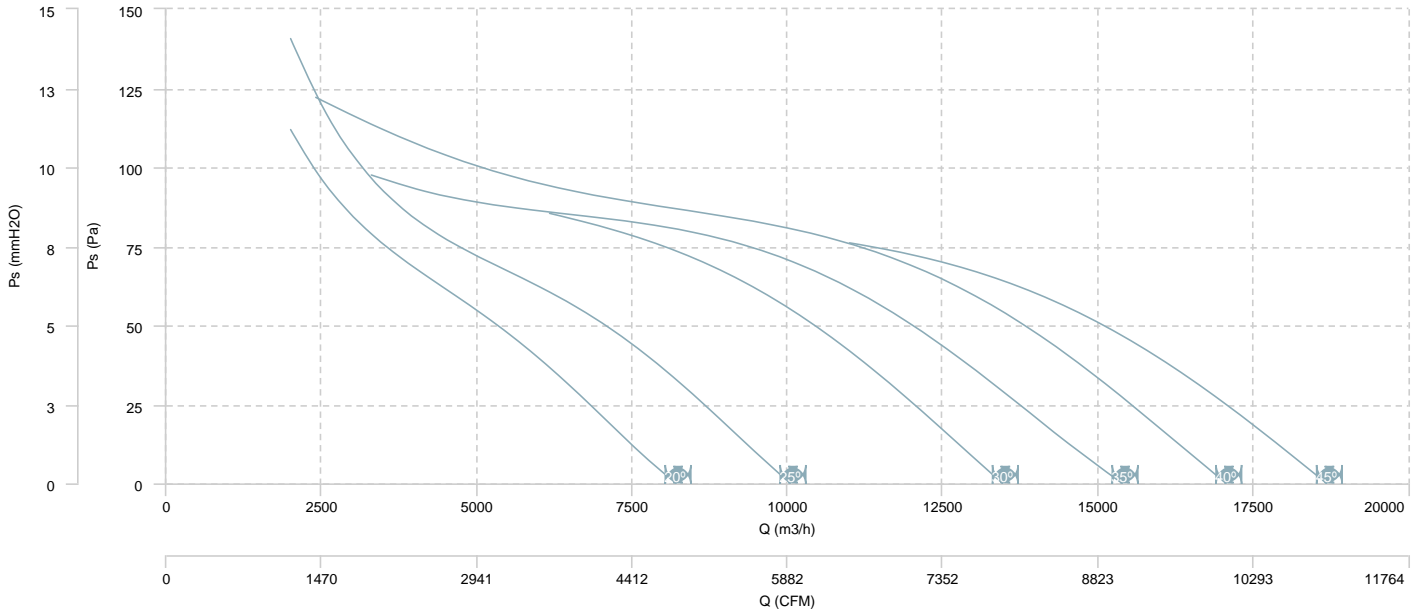

AIR FLOW - MECHANICAL POWER (8 poles)

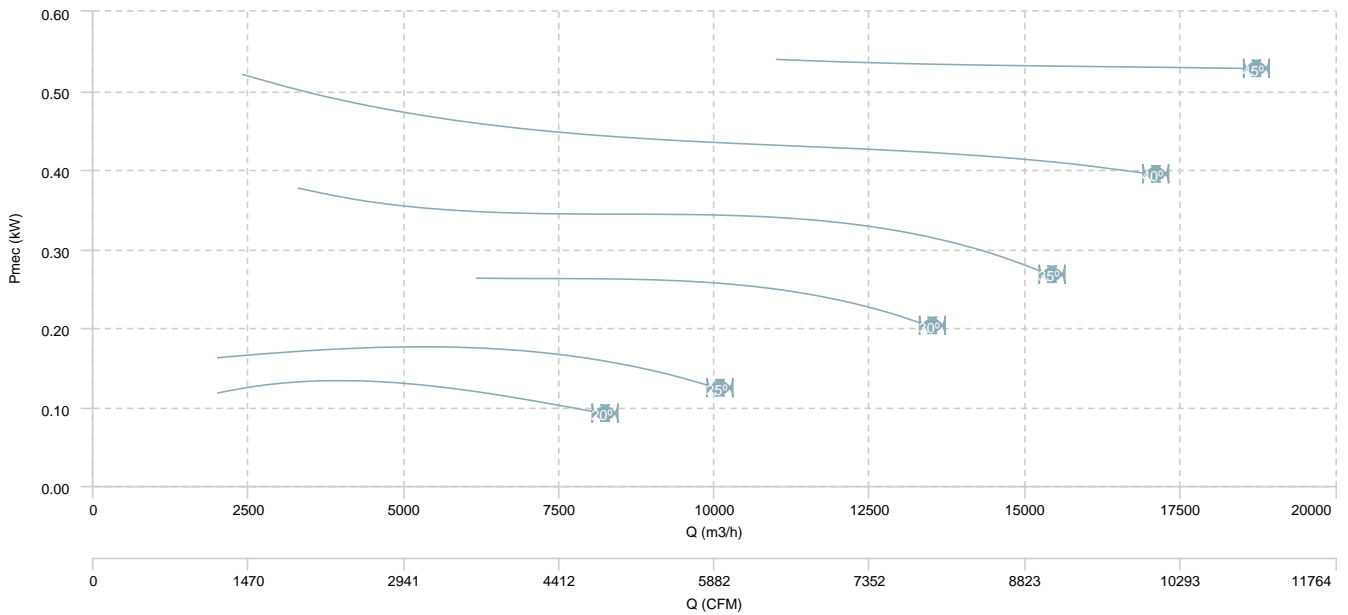

BOX HBF 90 T4 (A3:4) F400

AIR FLOW - PRESSURE

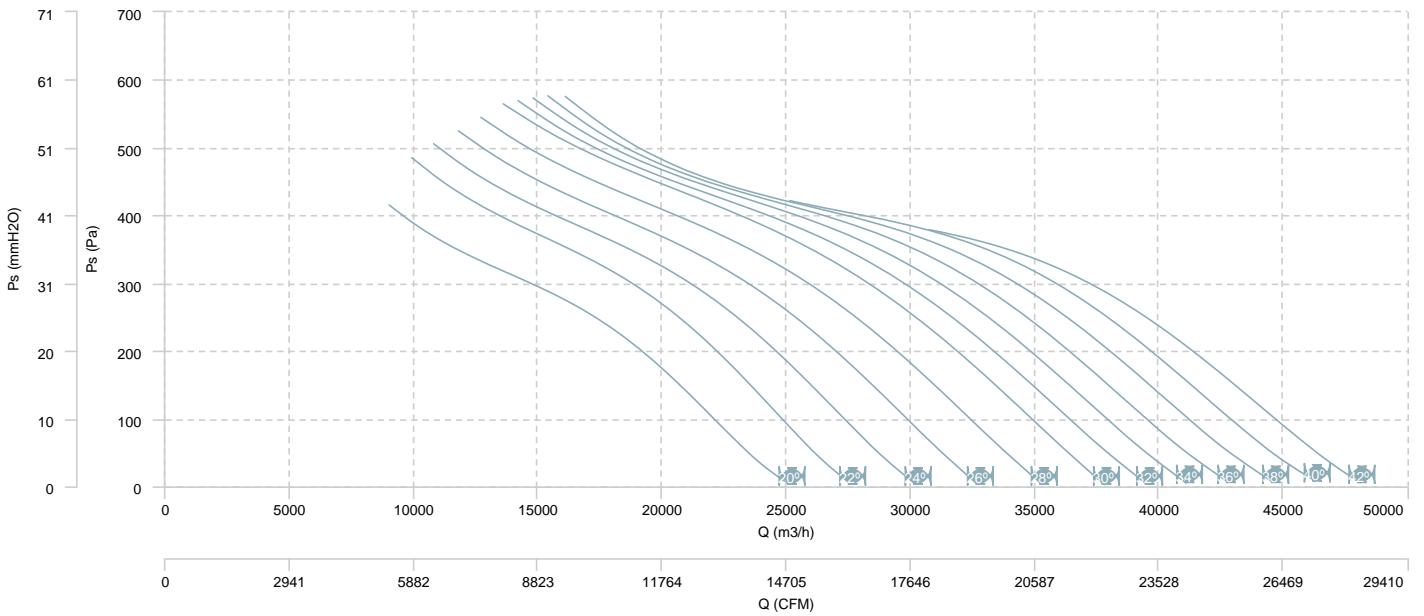

AIR FLOW - MECHANICAL POWER

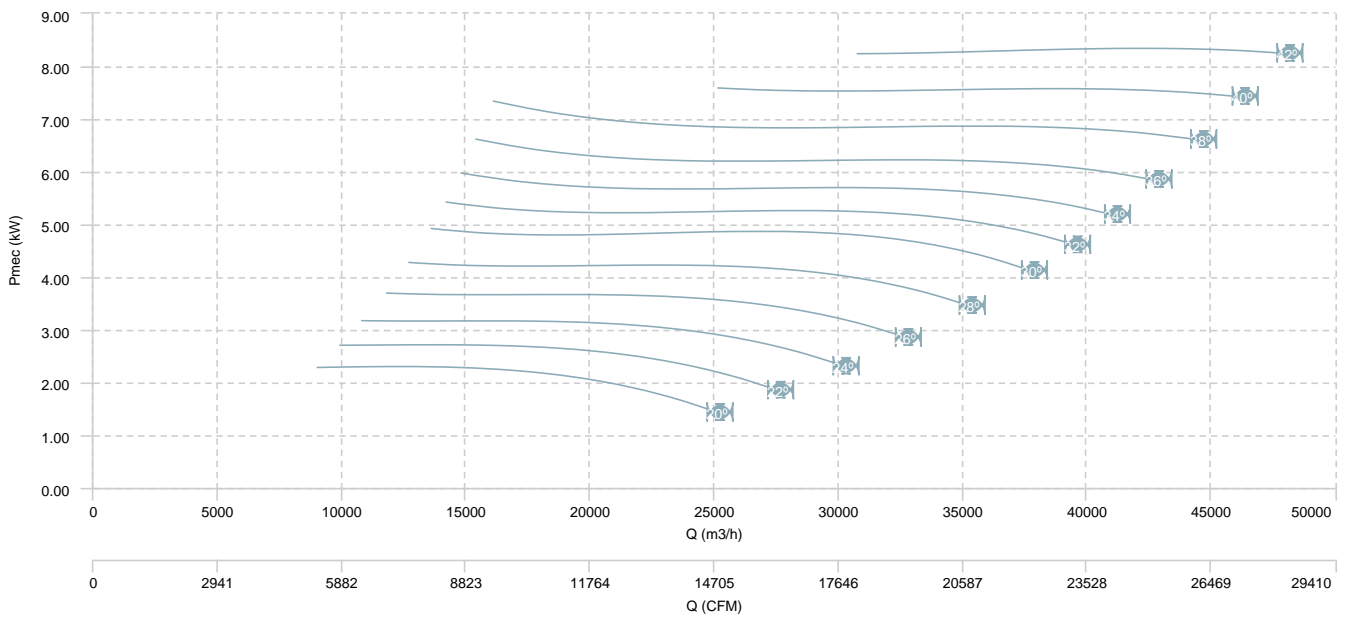



BOX HBF 90 T4 (A3:8) F400

AIR FLOW - PRESSURE

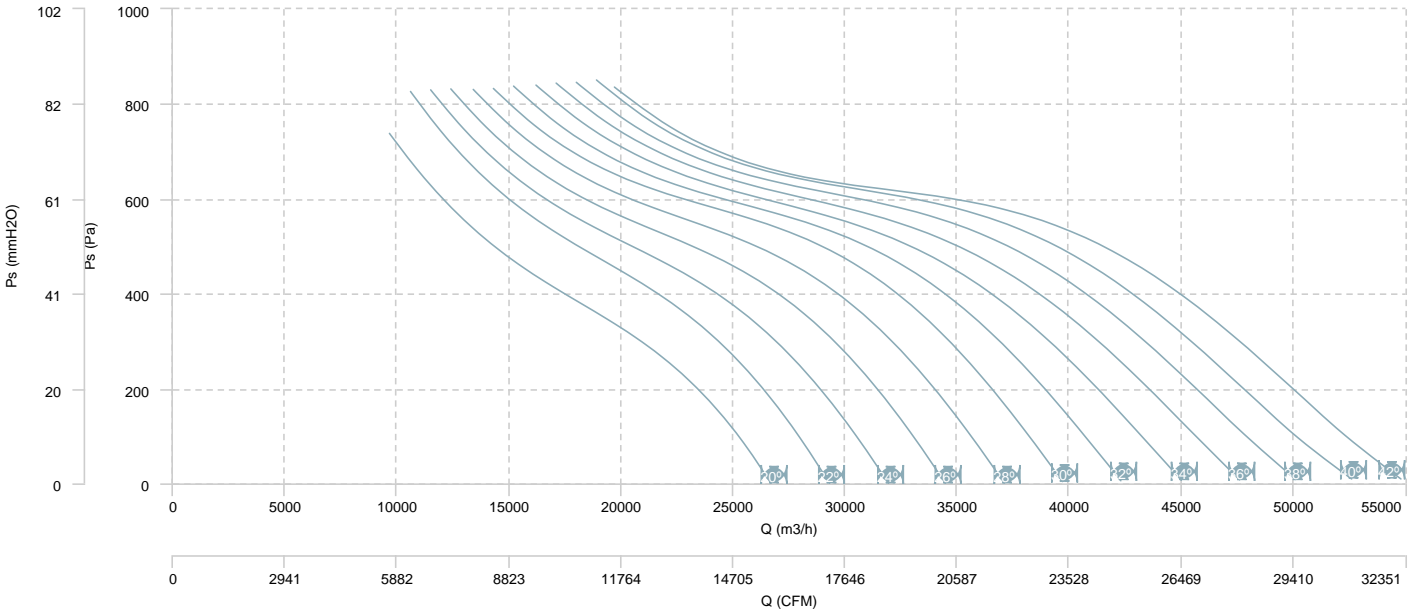

AIR FLOW - MECHANICAL POWER

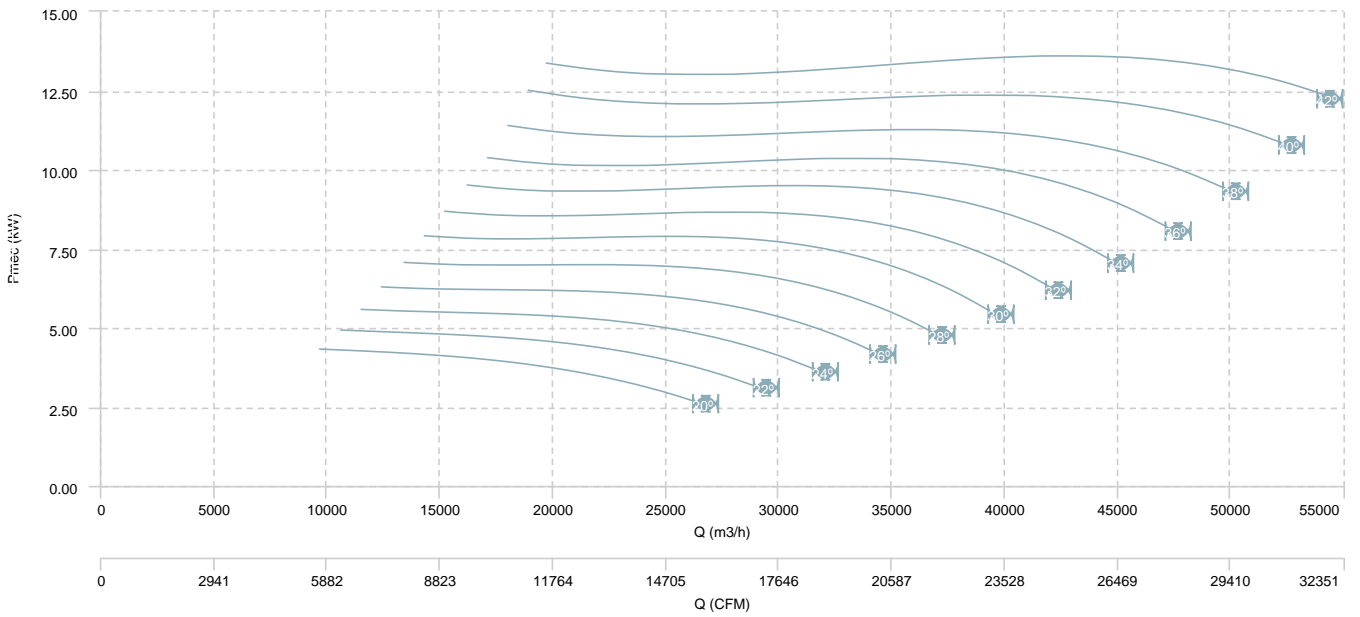

BOX HBF 90 T6 (A3:8) F400

AIR FLOW - PRESSURE

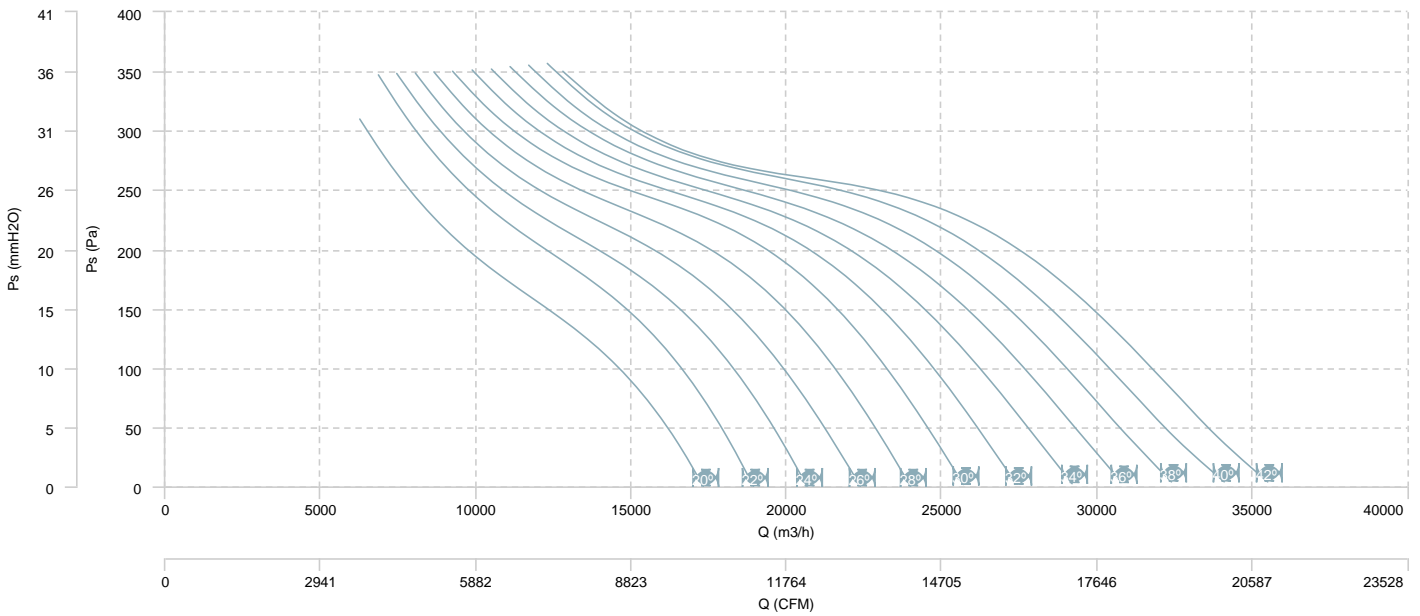

AIR FLOW - MECHANICAL POWER

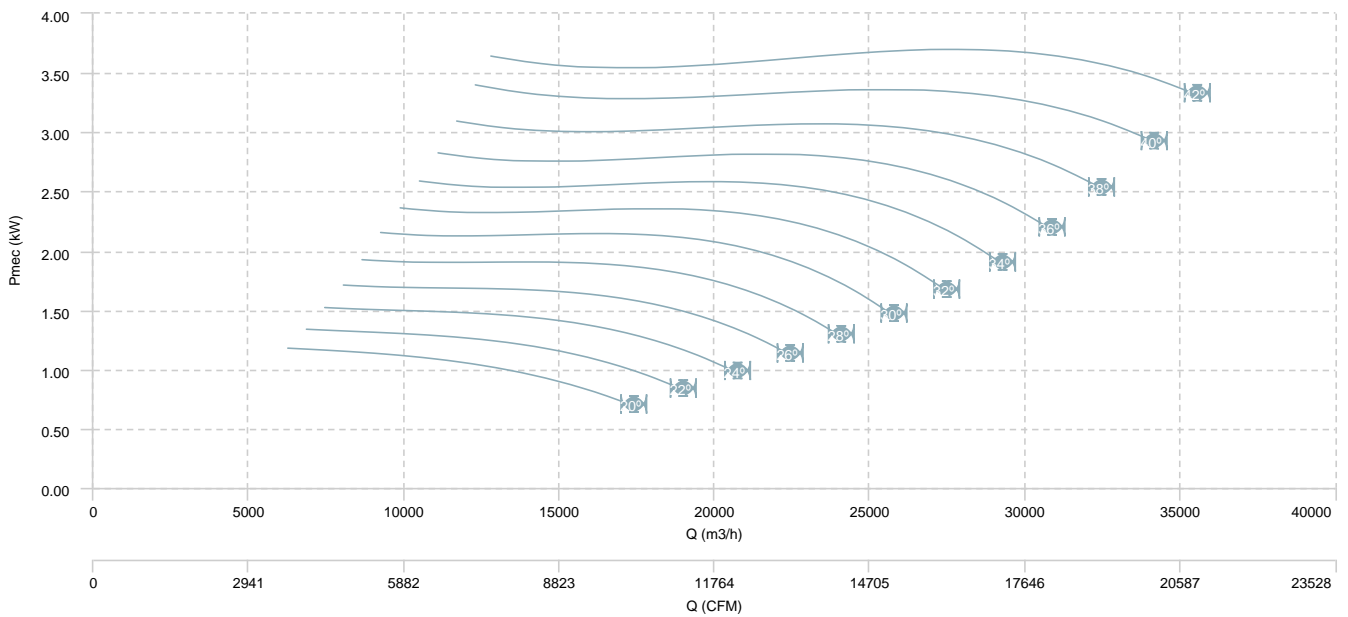

BOX HBF 90 T6 (A3:4) F400

**AIR FLOW - PRESSURE**

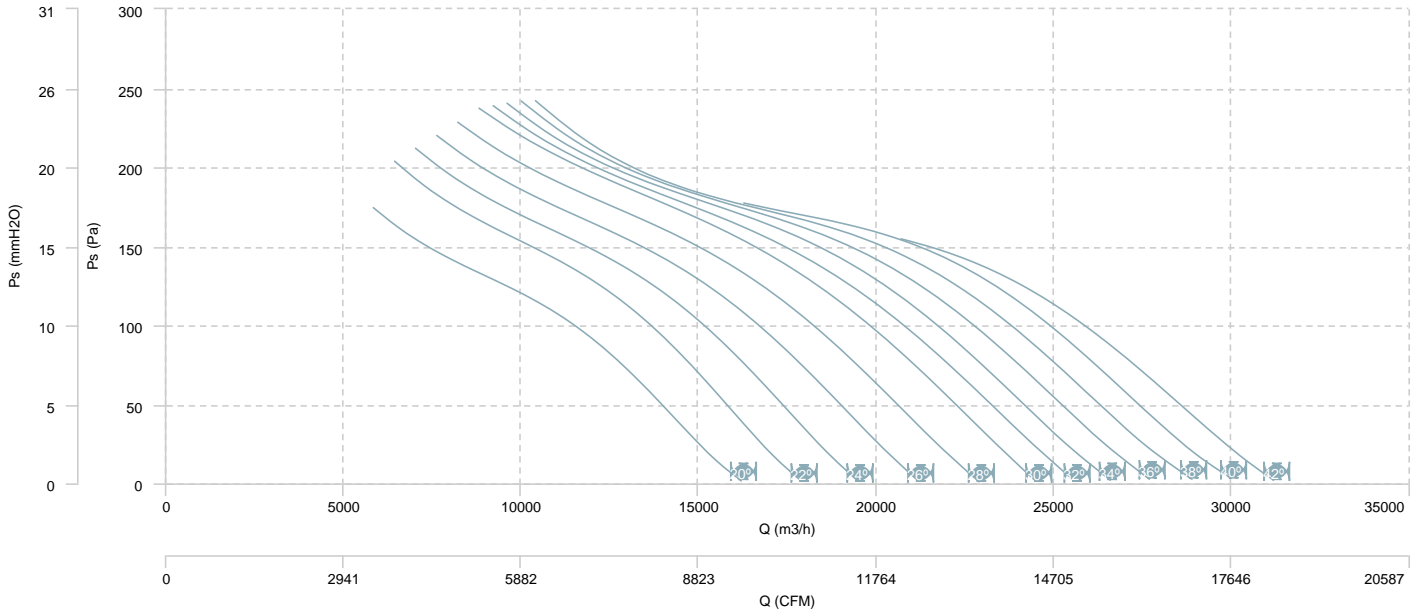

**AIR FLOW - MECHANICAL POWER**

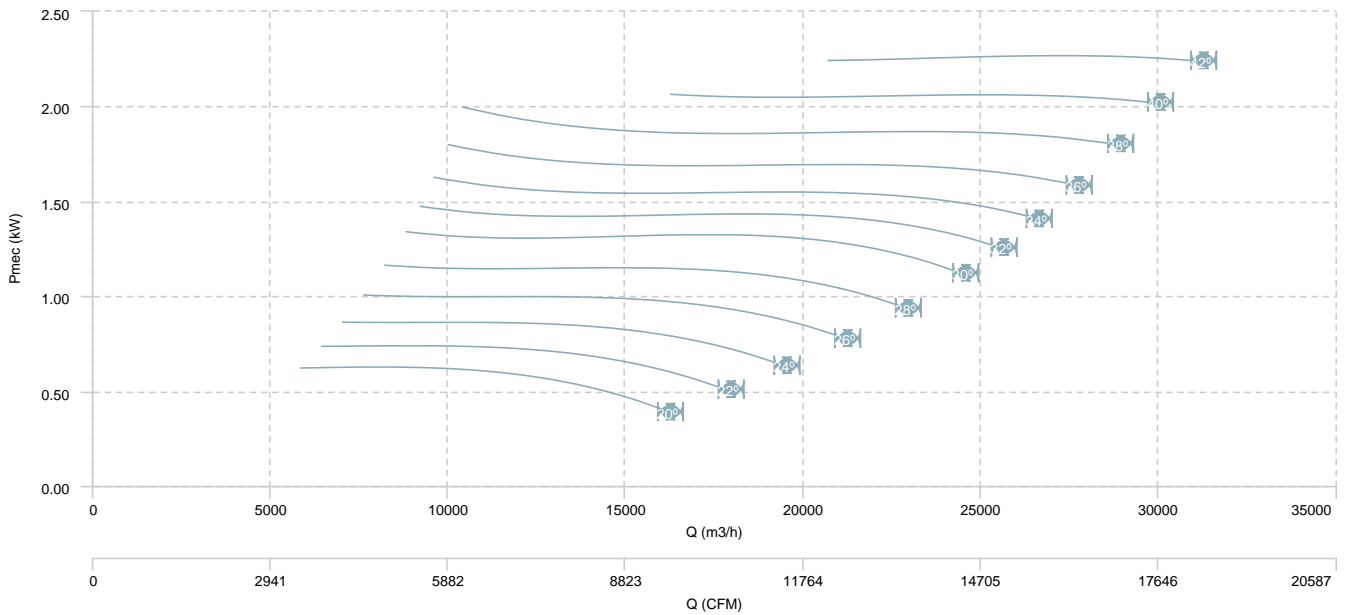

BOX HBF 90 T4/T8 (A3:4) F400

AIR FLOW - PRESSURE (4 poles)

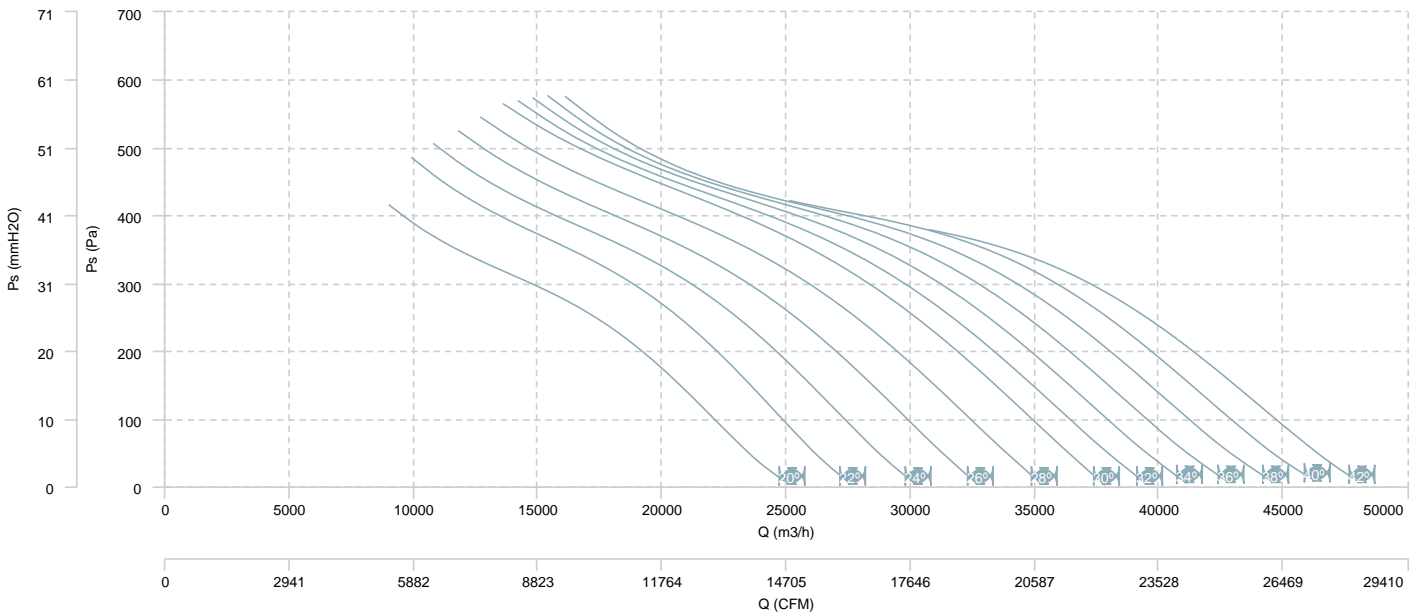

AIR FLOW - MECHANICAL POWER (4 poles)

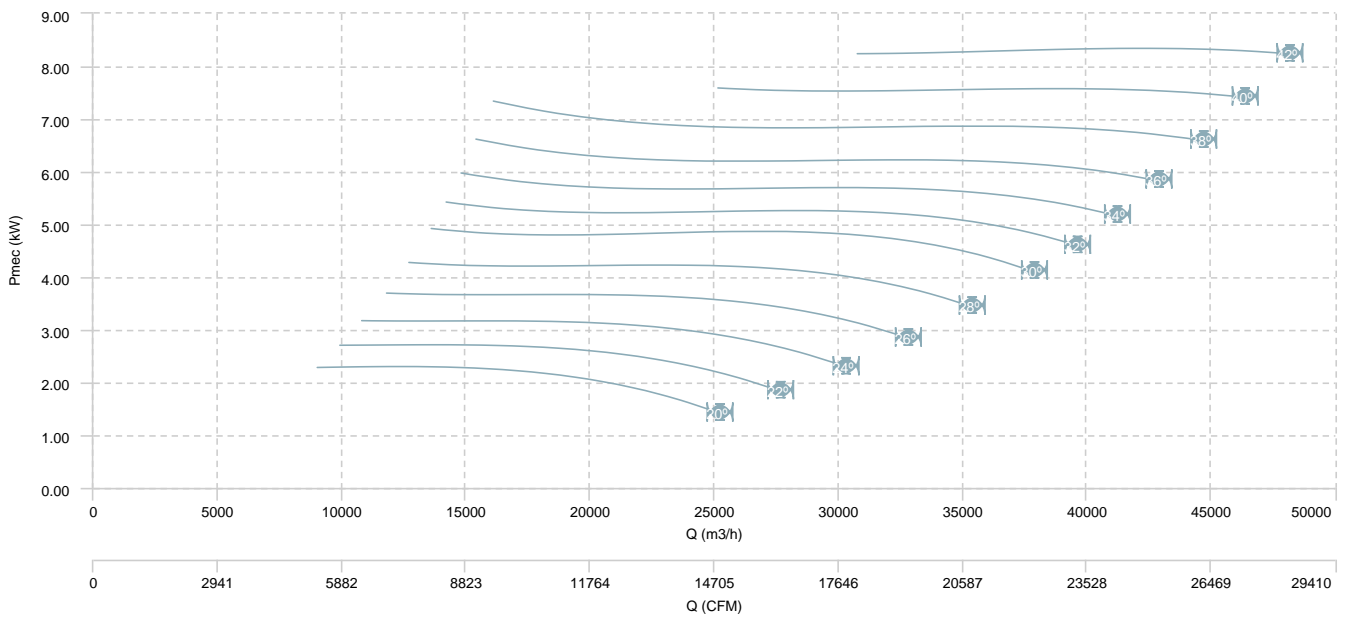

BOX HBF 90 T4/T8 (A3:4) F400

AIR FLOW - PRESSURE (8 poles)

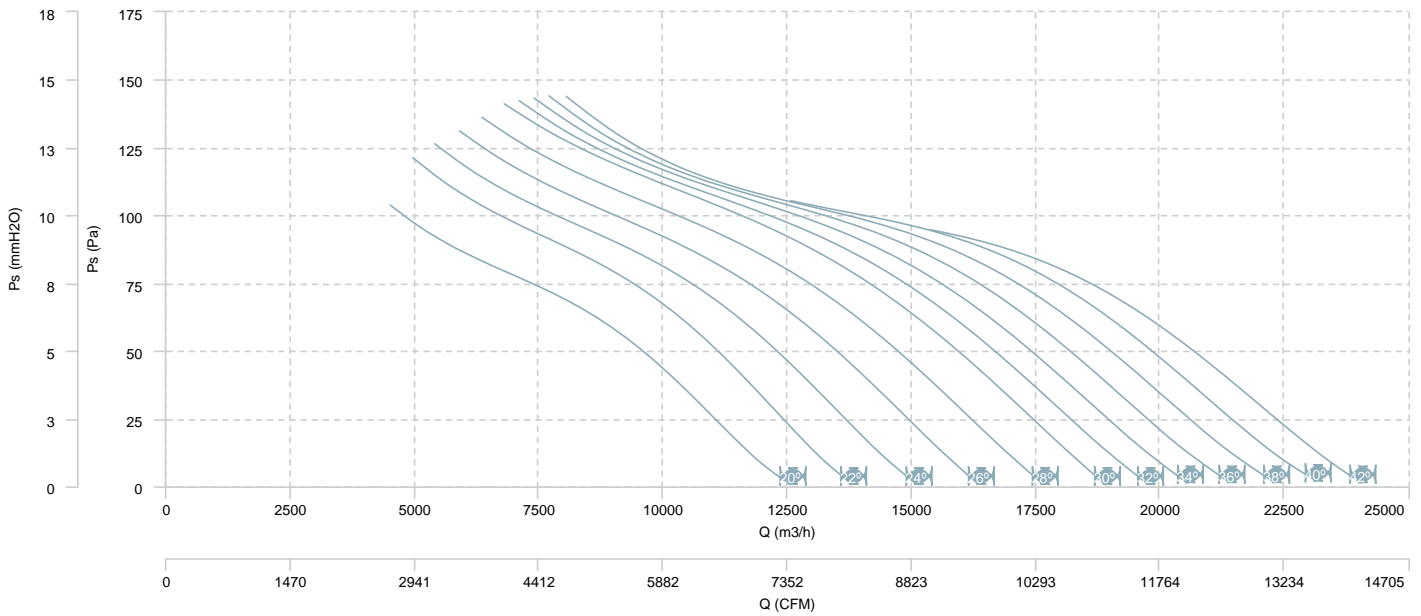

AIR FLOW - MECHANICAL POWER (8 poles)

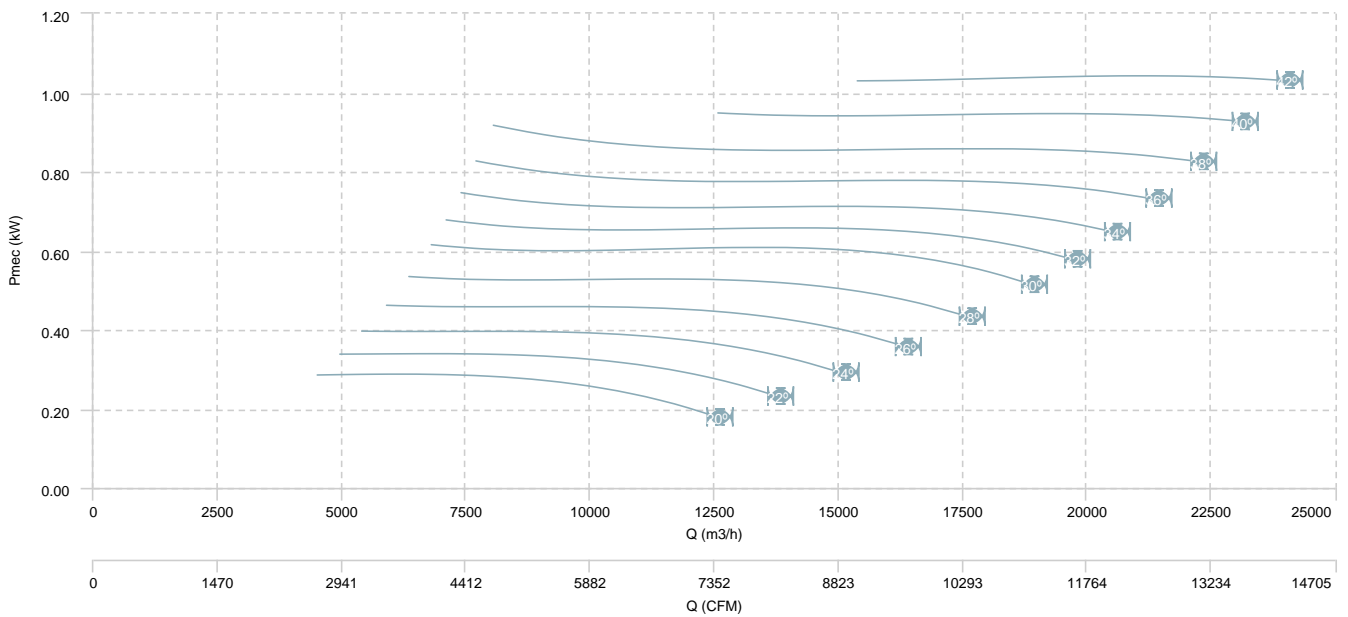

BOX HBF 90 T4/T8 (A3:8) F400

AIR FLOW - PRESSURE (4 poles)

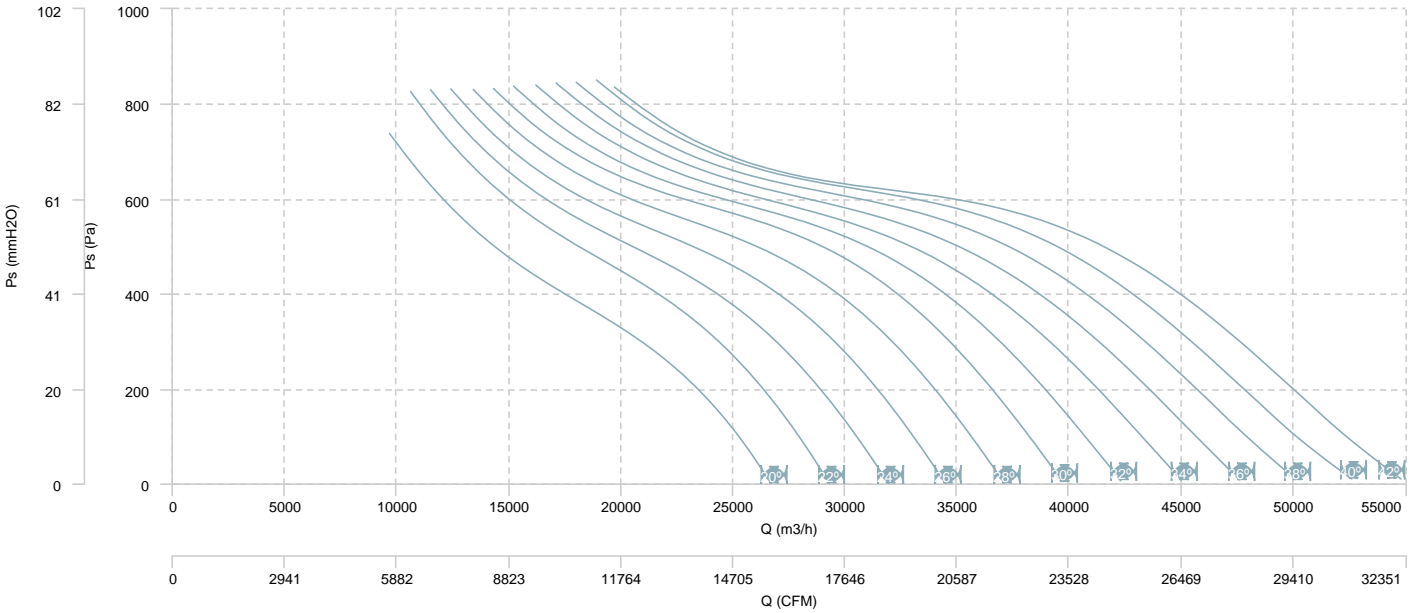

AIR FLOW - MECHANICAL POWER (4 poles)

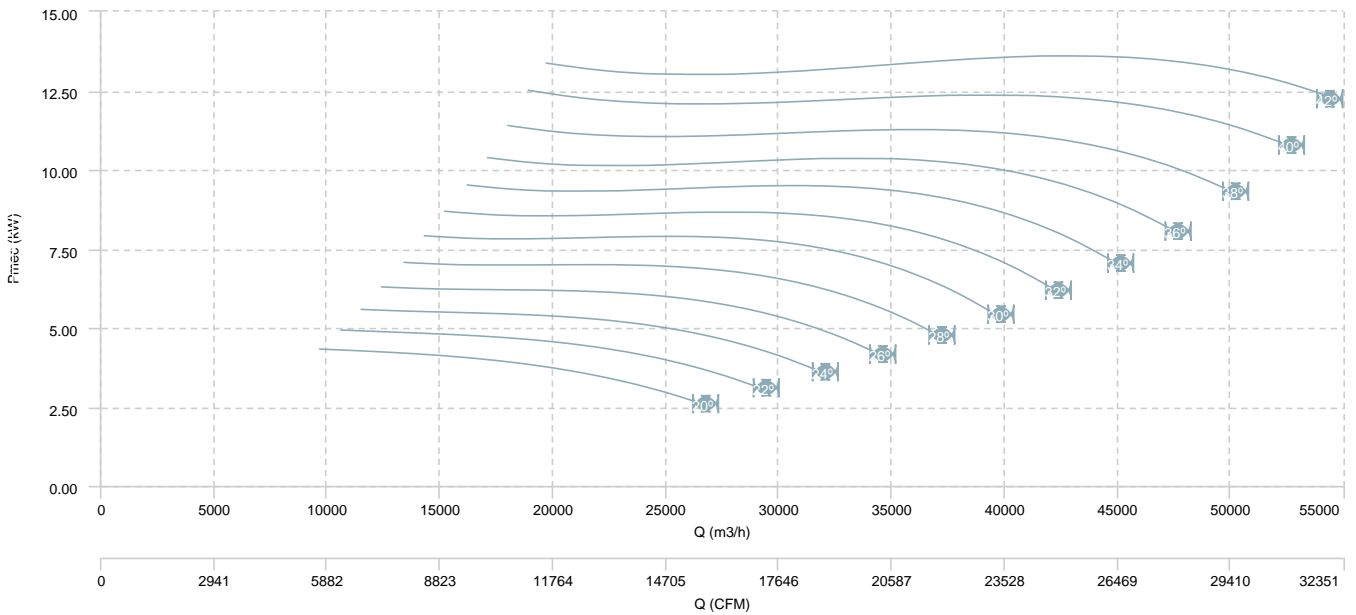

BOX HBF 90 T4/T8 (A3:8) F400

AIR FLOW - PRESSURE (8 poles)

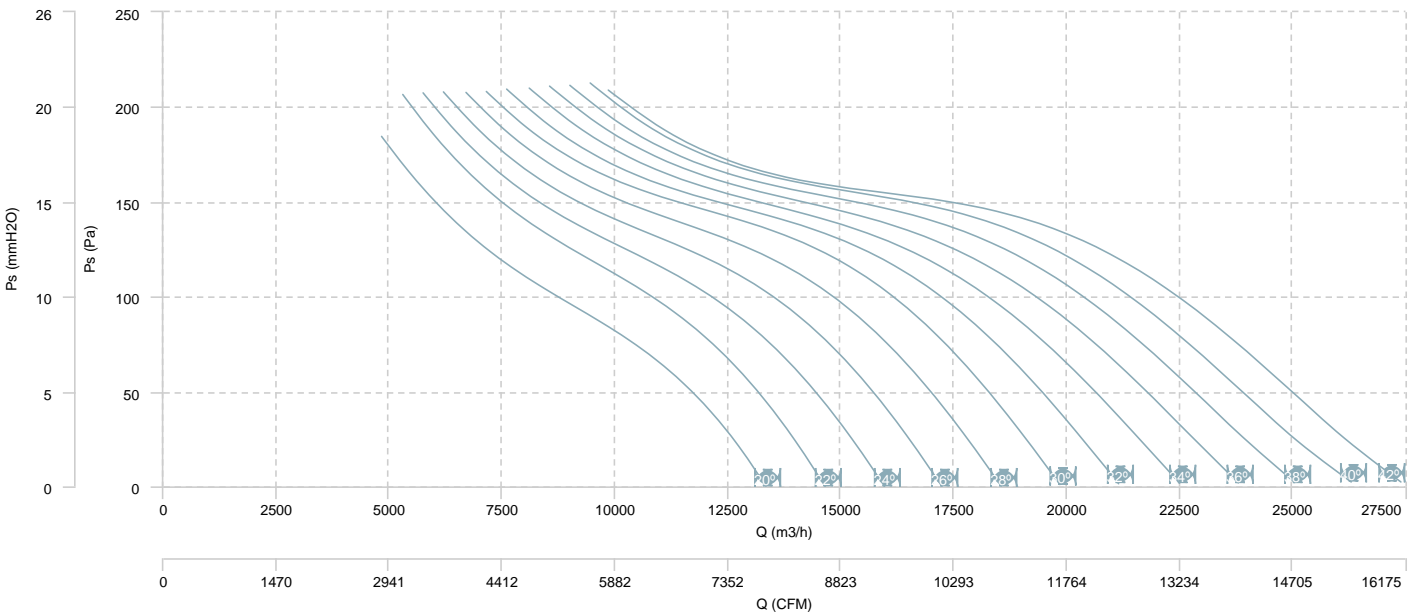

AIR FLOW - MECHANICAL POWER (8 poles)

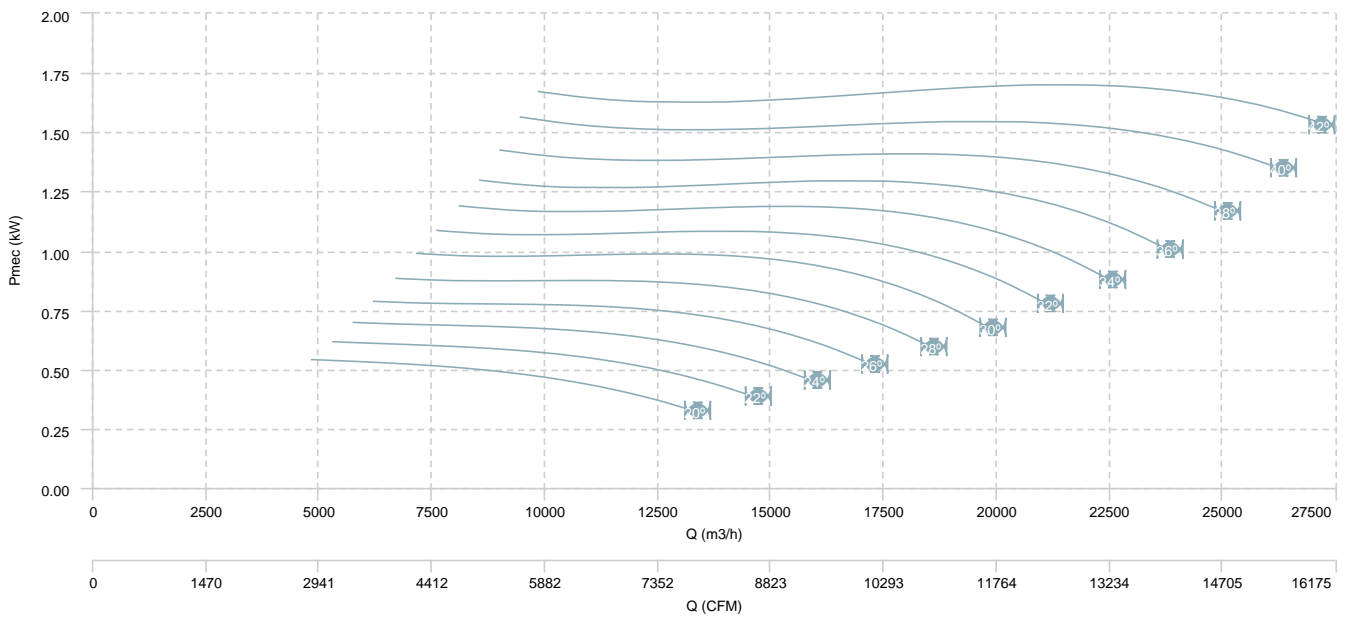

BOX HBF 100 T4 (A3:4) F400

AIR FLOW - PRESSURE

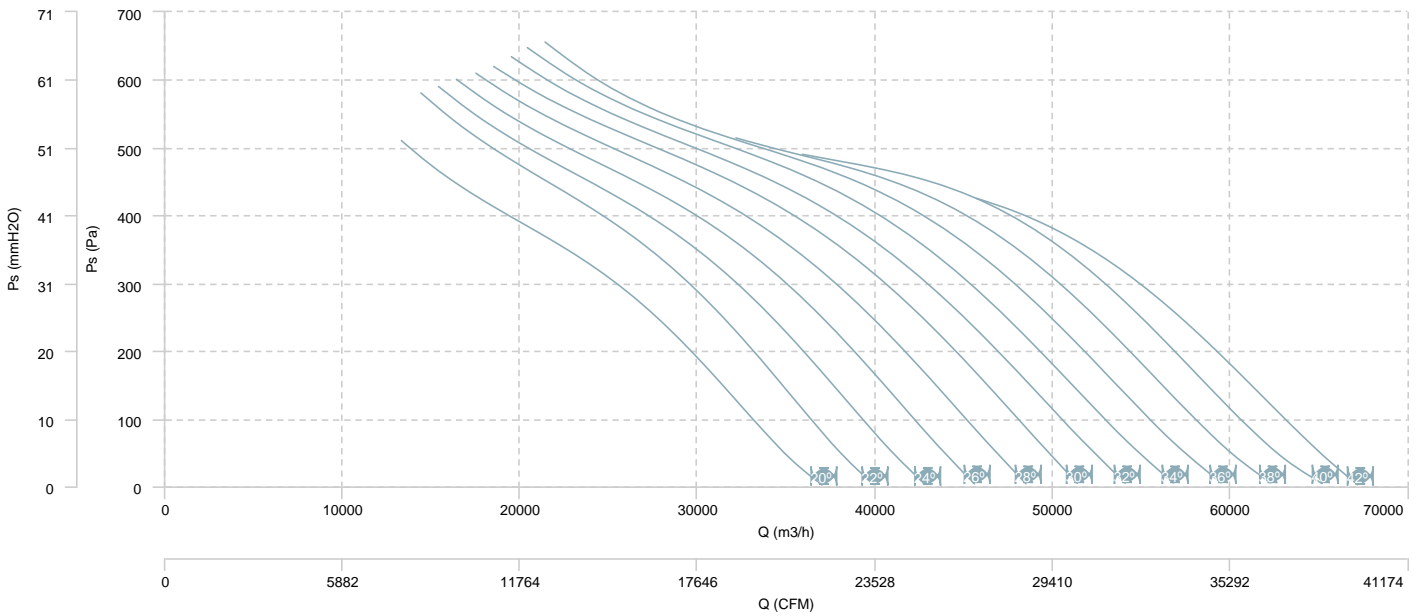

AIR FLOW - MECHANICAL POWER

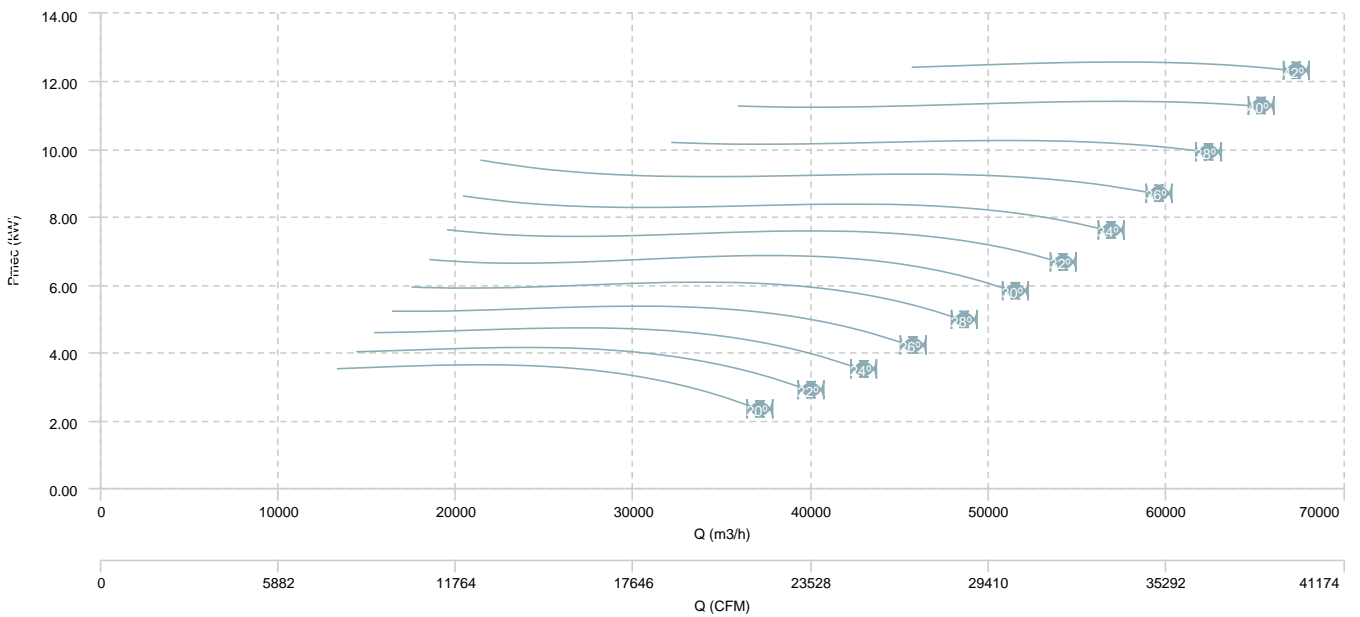



BOX HBF 100 T4 (A3:8) F400

AIR FLOW - PRESSURE

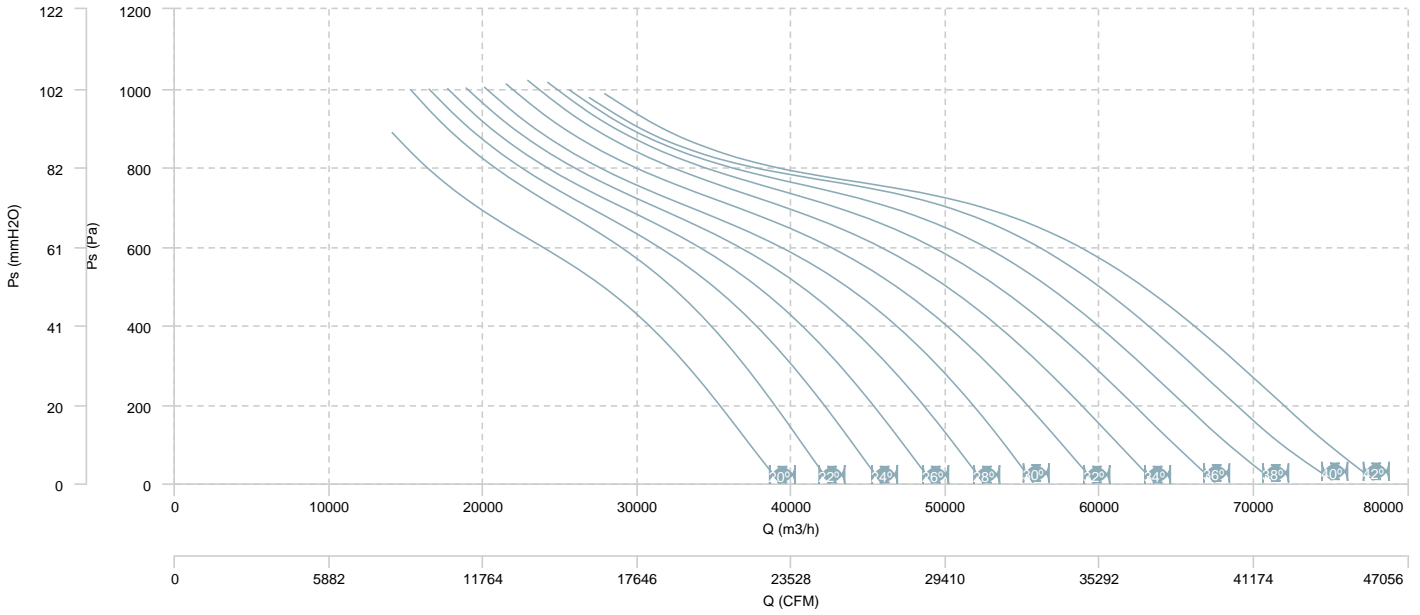

AIR FLOW - MECHANICAL POWER

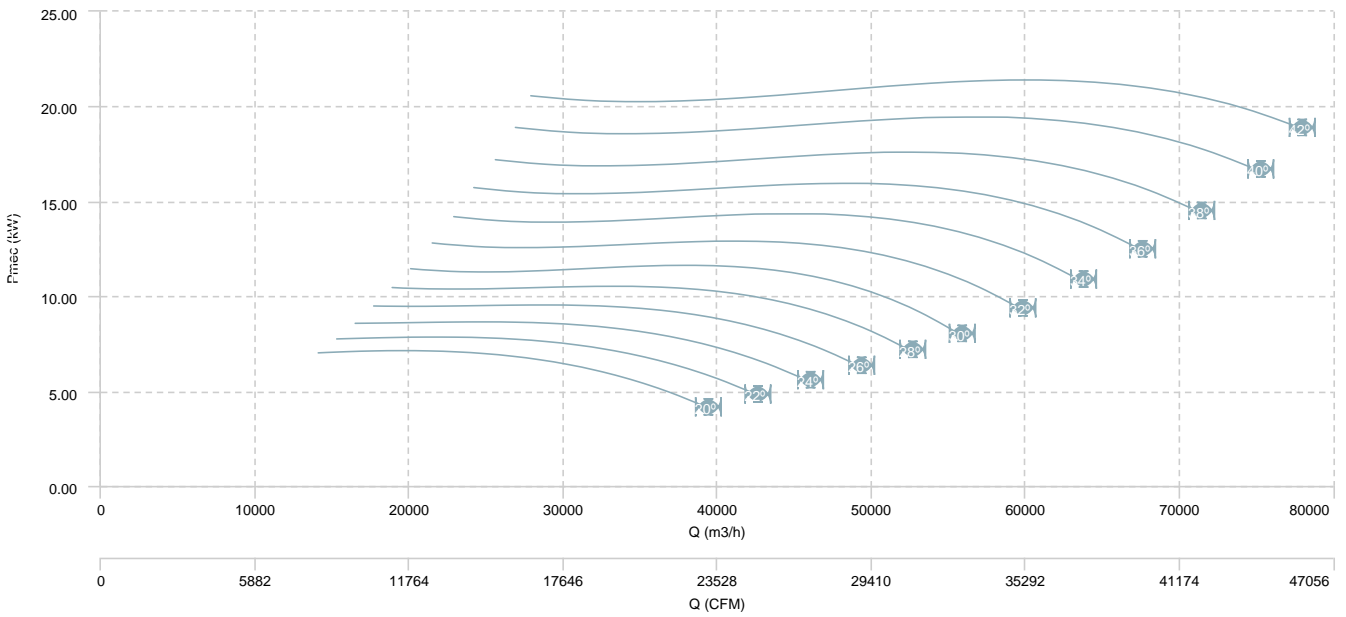

BOX HBF 100 T6 (A3:4) F400

AIR FLOW - PRESSURE

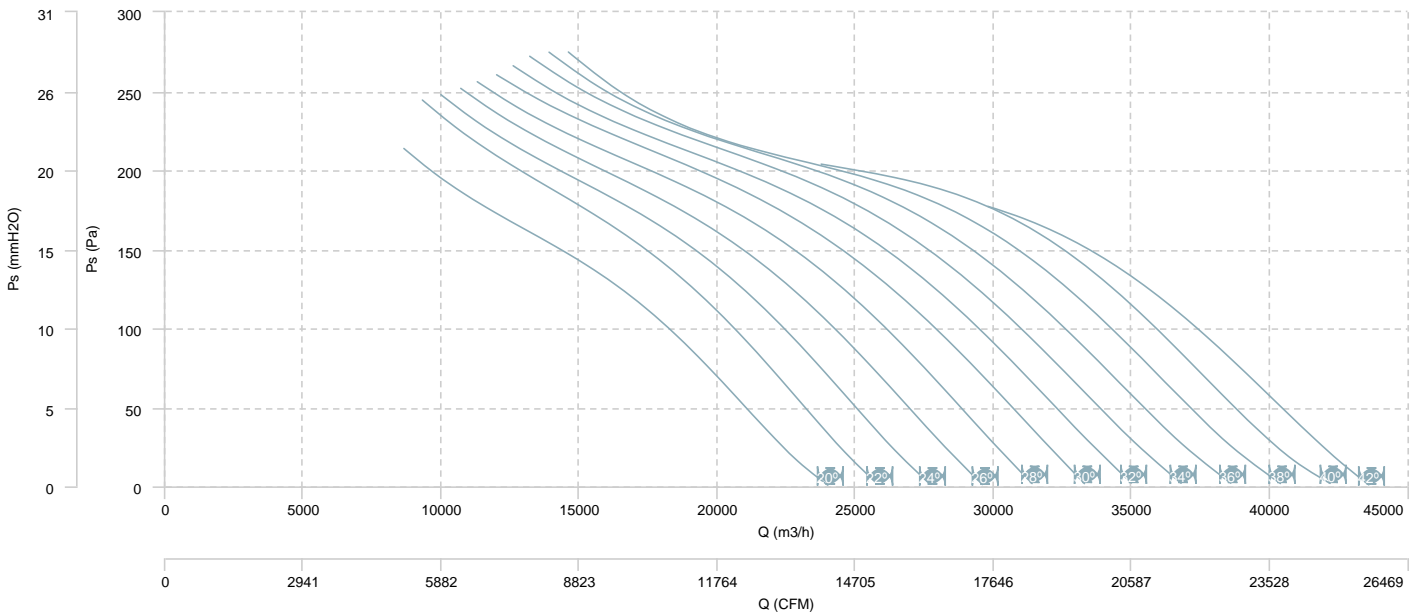

AIR FLOW - MECHANICAL POWER

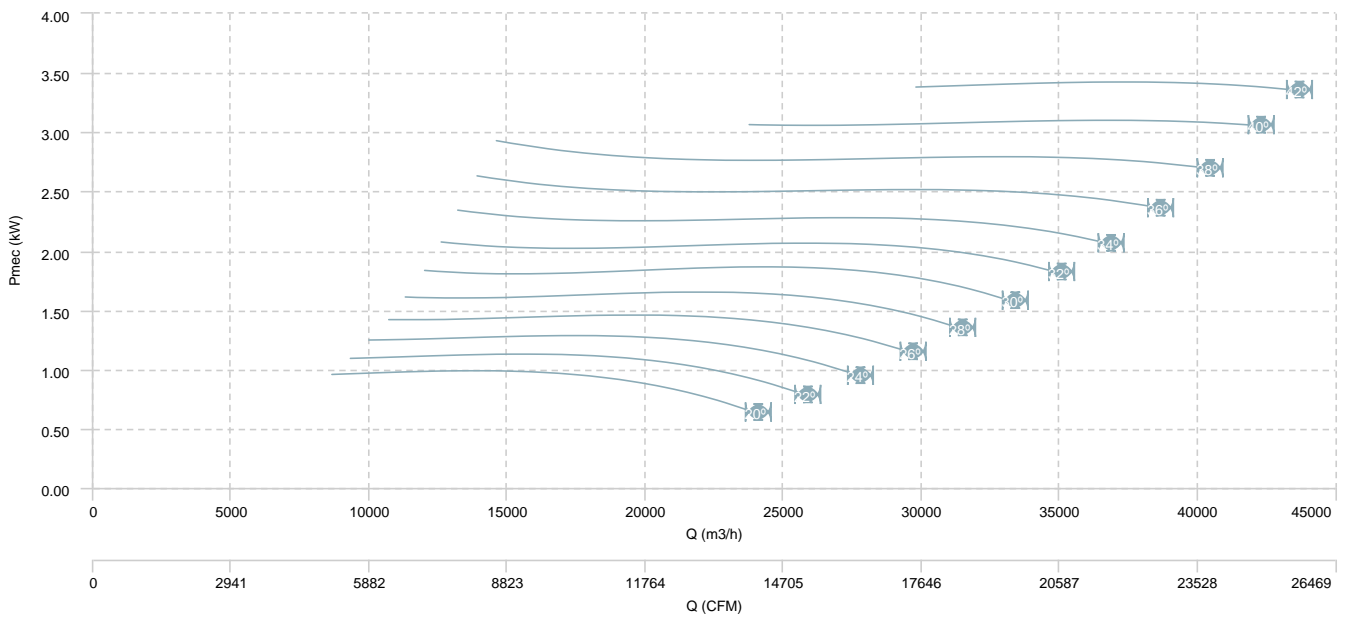

BOX HBF 100 T6 (A3:8) F400

**AIR FLOW - PRESSURE**

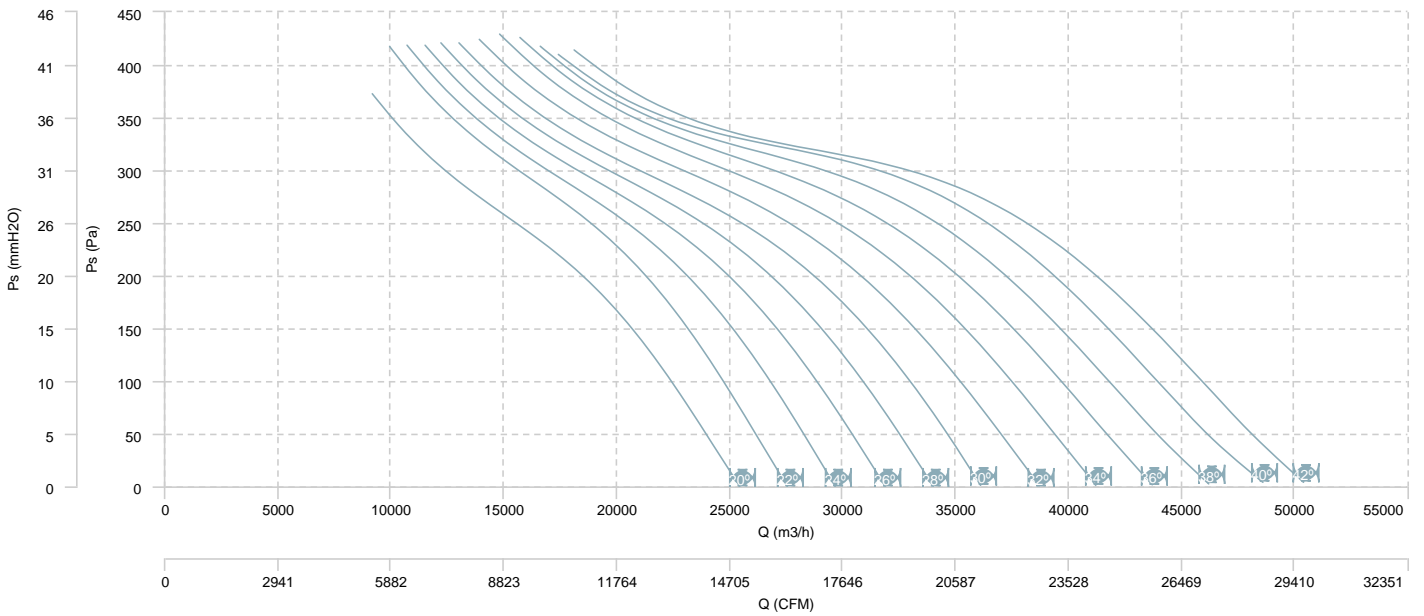

**AIR FLOW - MECHANICAL POWER**

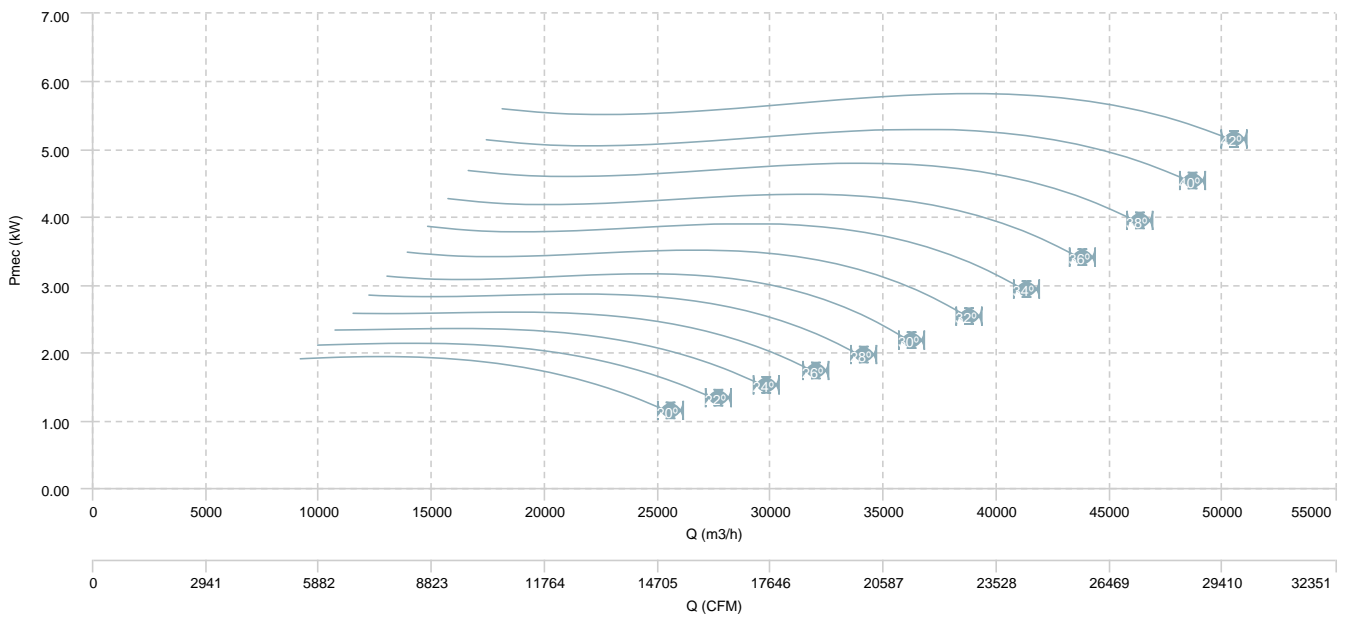

BOX HBF 100 T4/T8 (A3:4) F400

AIR FLOW - PRESSURE (4 poles)

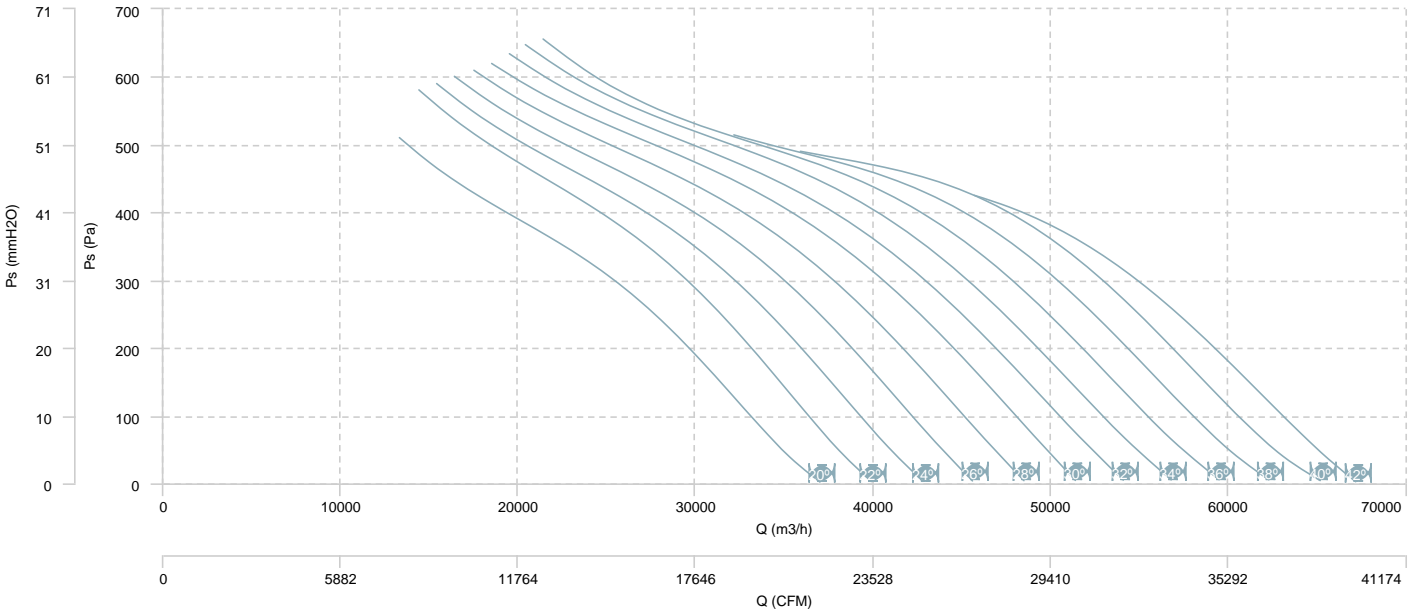

AIR FLOW - MECHANICAL POWER (4 poles)

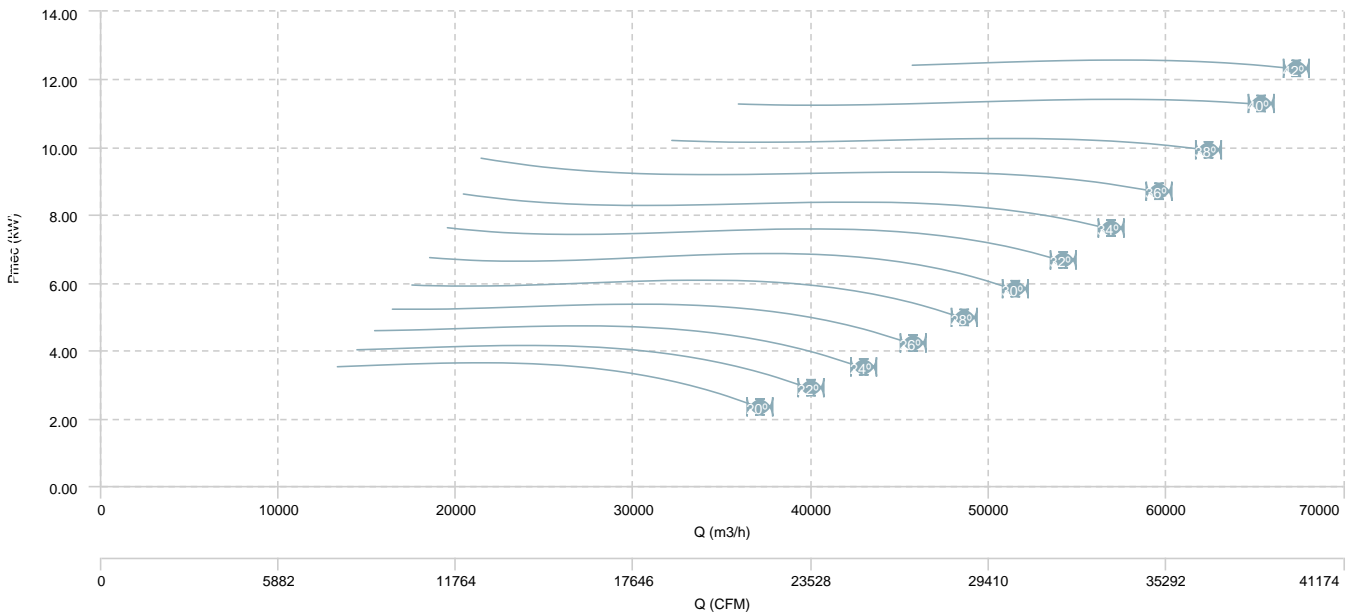

BOX HBF 100 T4/T8 (A3:4) F400

AIR FLOW - PRESSURE (8 poles)

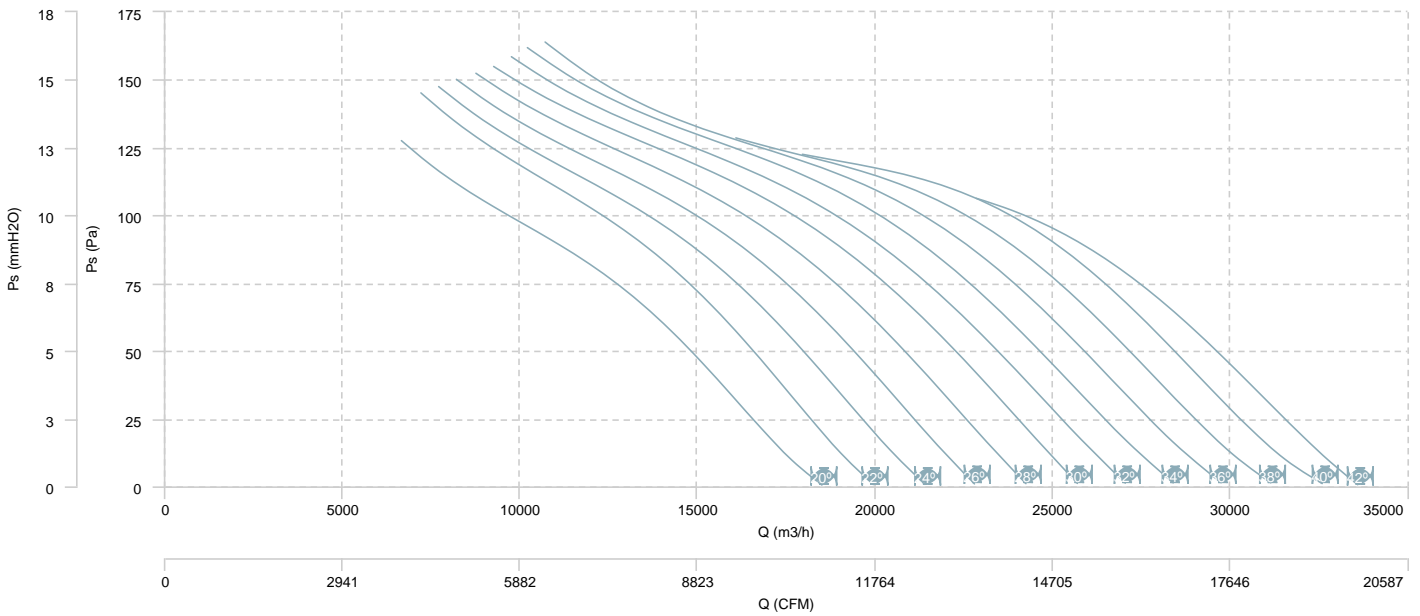

AIR FLOW - MECHANICAL POWER (8 poles)

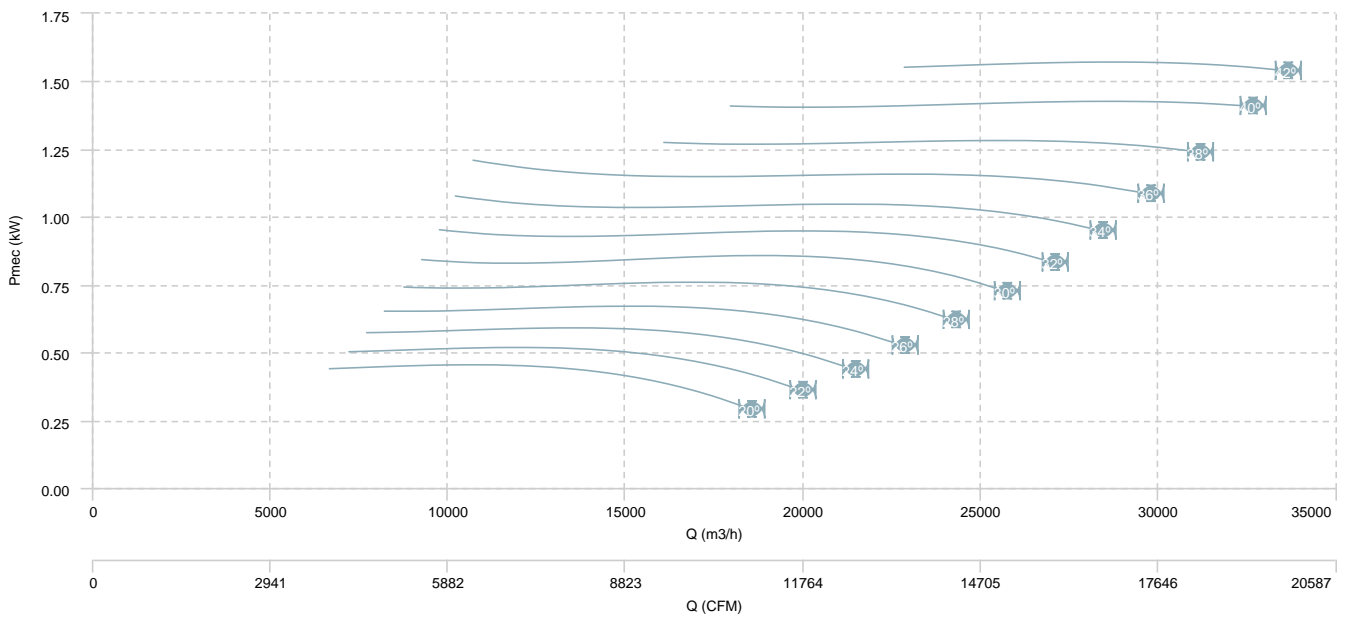

BOX HBF 100 T4/T8 (A3:8) F400

AIR FLOW - PRESSURE (4 poles)

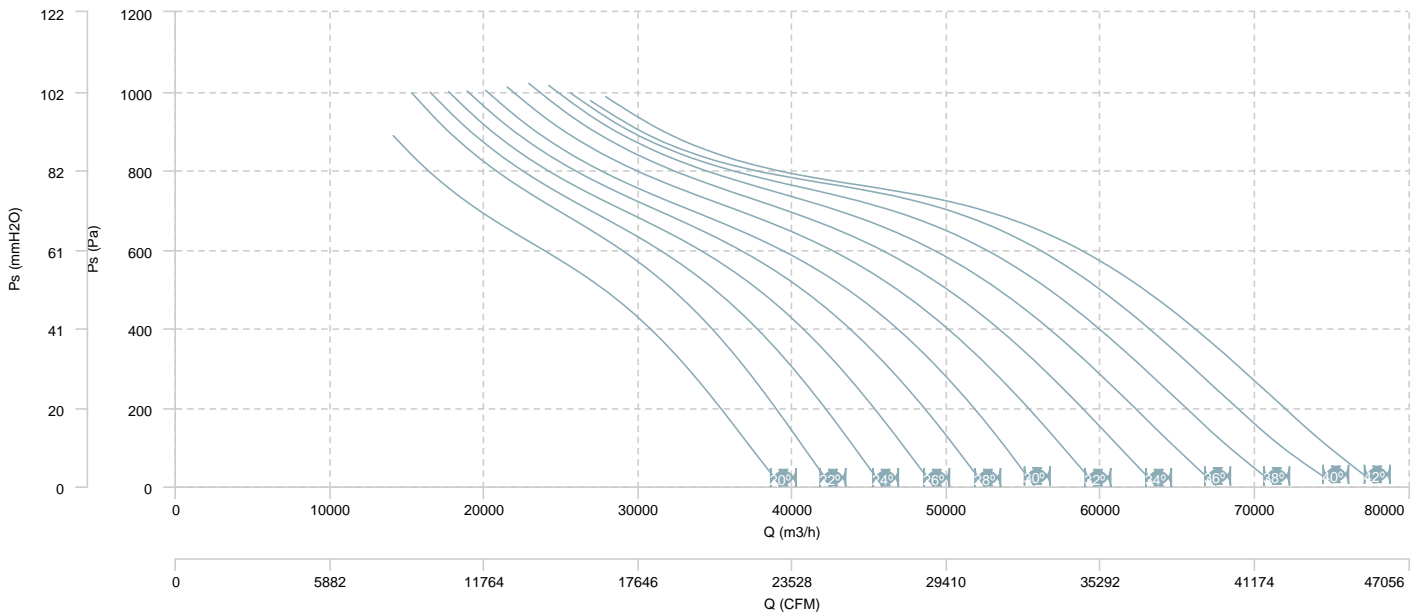

AIR FLOW - MECHANICAL POWER (4 poles)

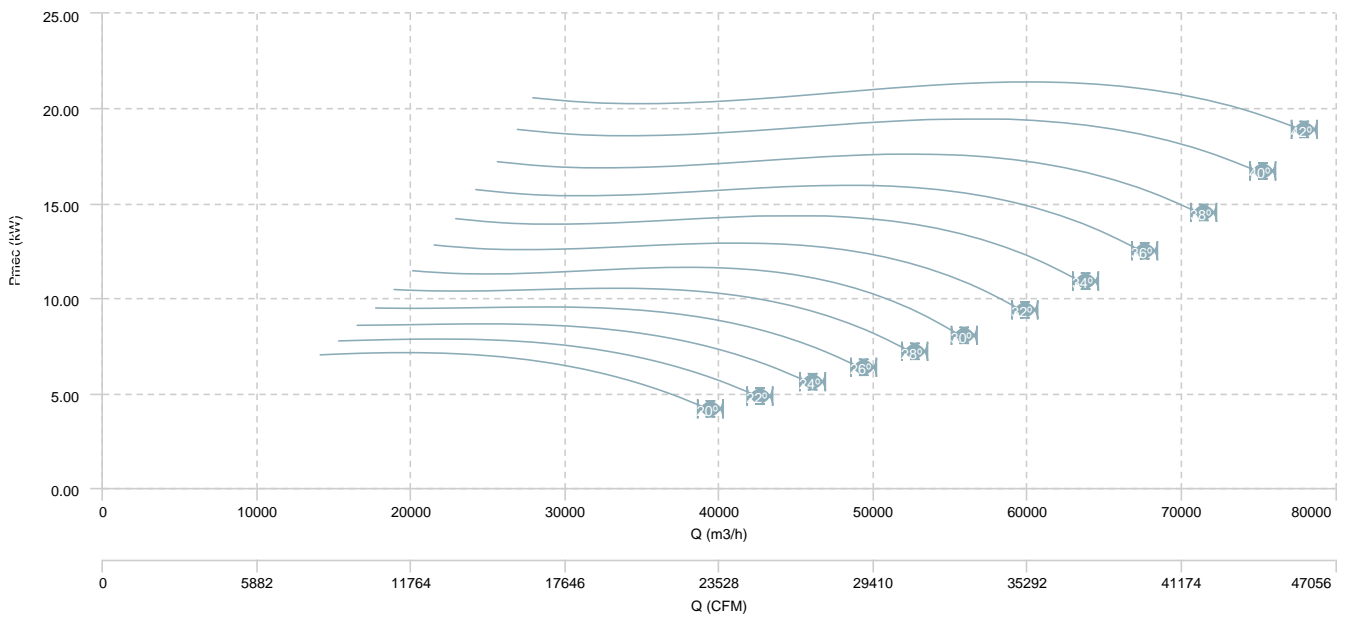

BOX HBF 100 T4/T8 (A3:8) F400

AIR FLOW - PRESSURE (8 poles)

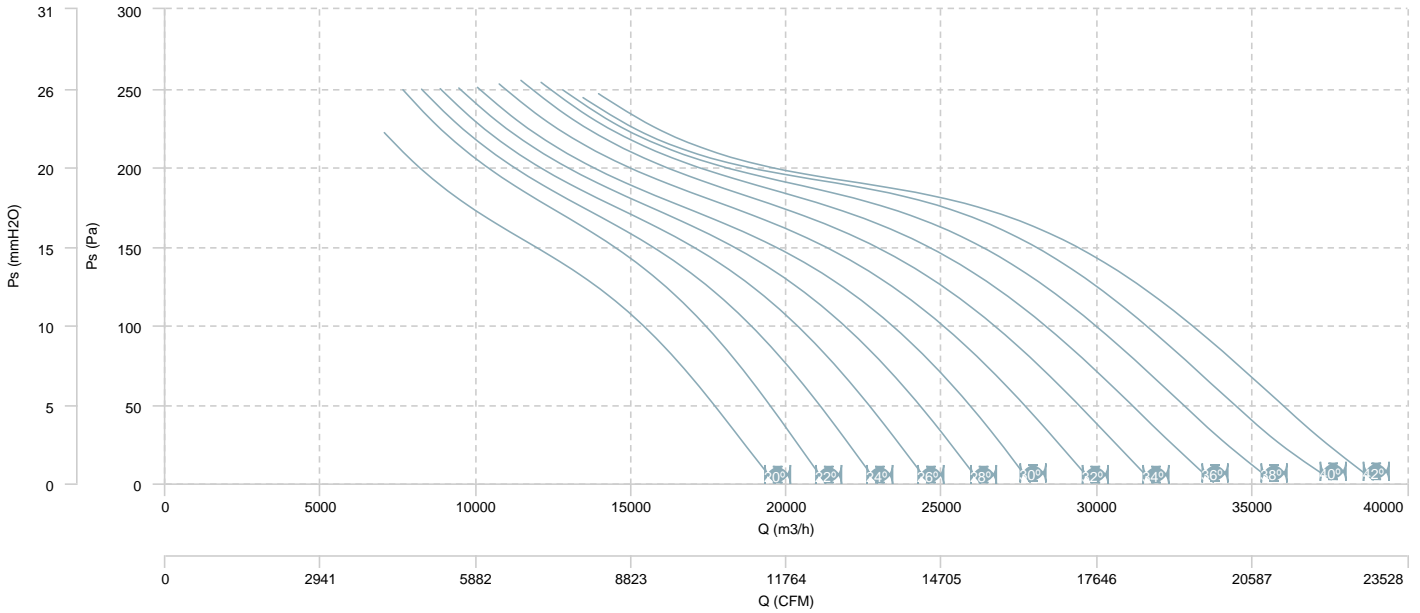

AIR FLOW - MECHANICAL POWER (8 poles)

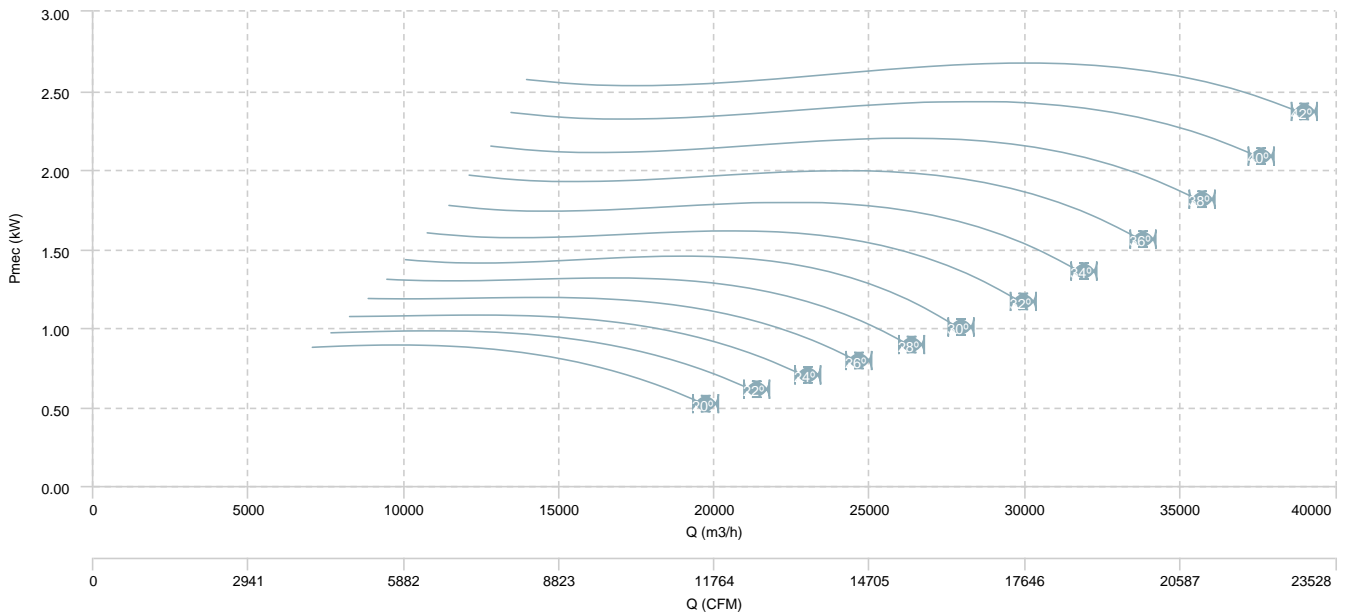

BOX HBF 112 T4 (A3:8) F400

AIR FLOW - PRESSURE

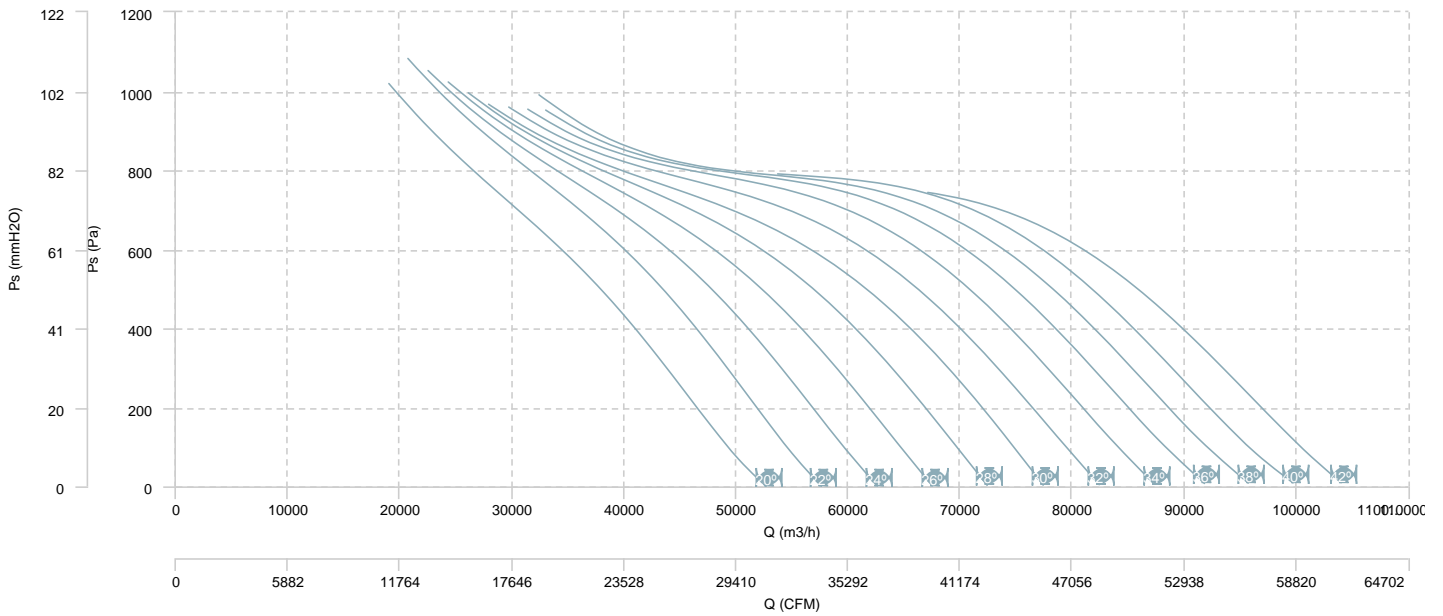

AIR FLOW - MECHANICAL POWER

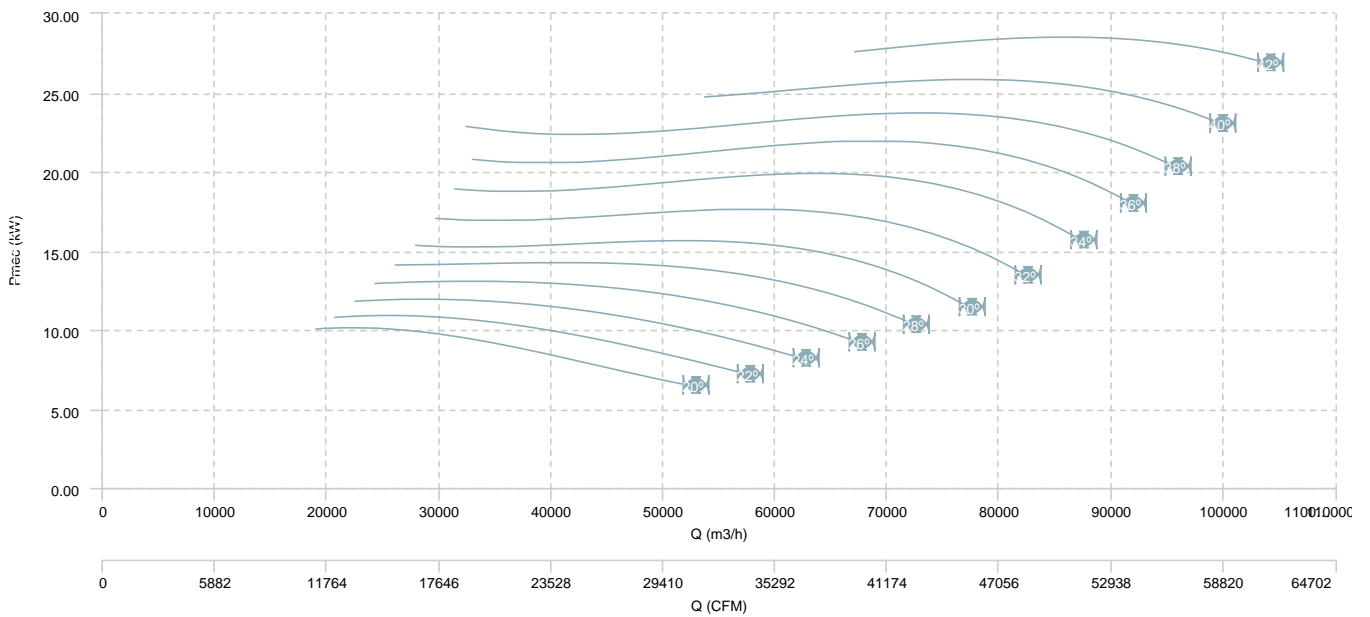



BOX HBF 112 T4 (A3:4) F400

AIR FLOW - PRESSURE

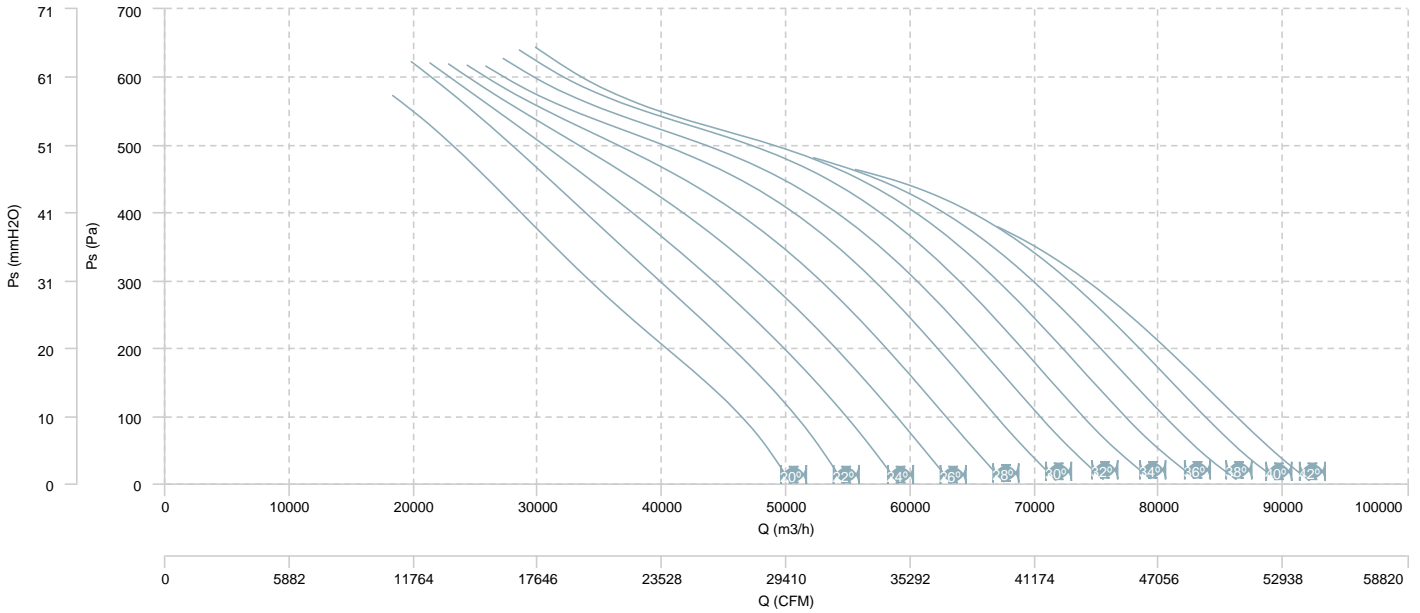

AIR FLOW - MECHANICAL POWER

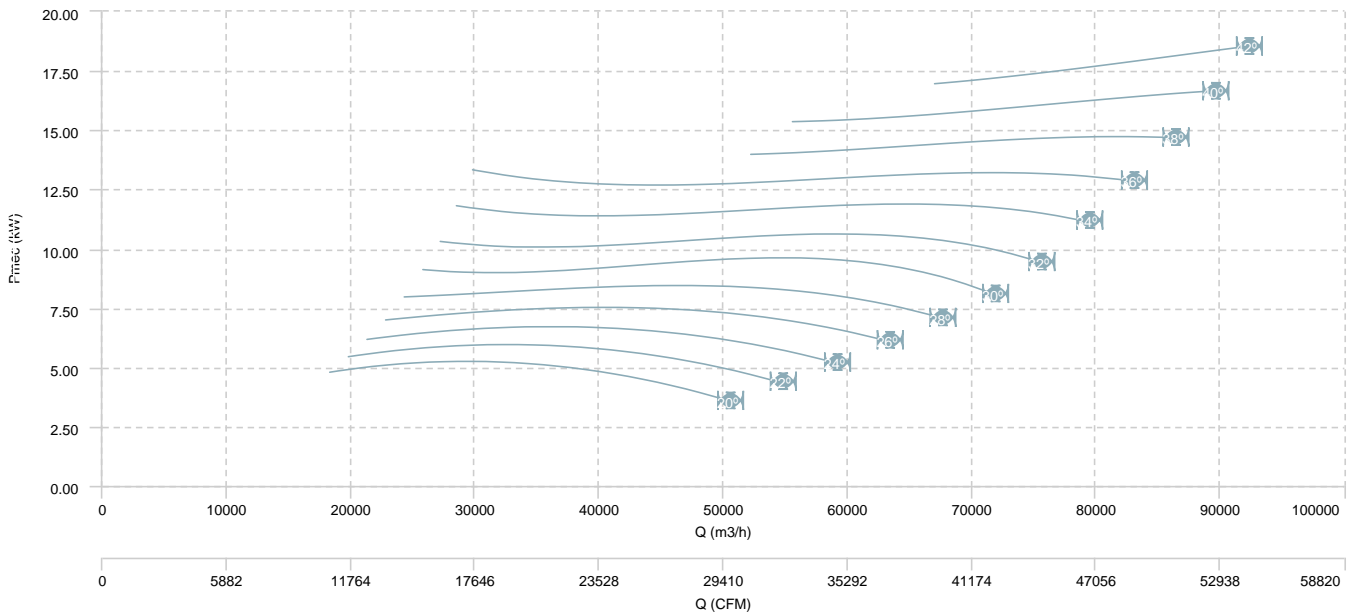

BOX HBF 112 T6 (A3:4) F400

AIR FLOW - PRESSURE

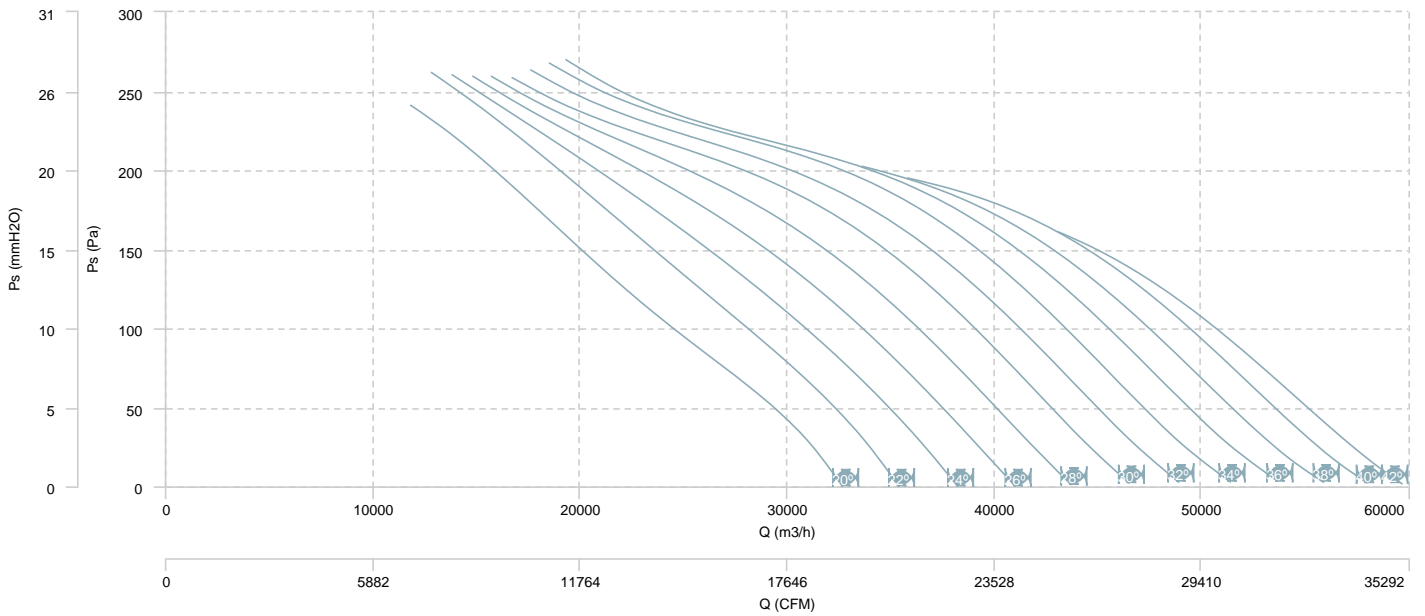

AIR FLOW - MECHANICAL POWER

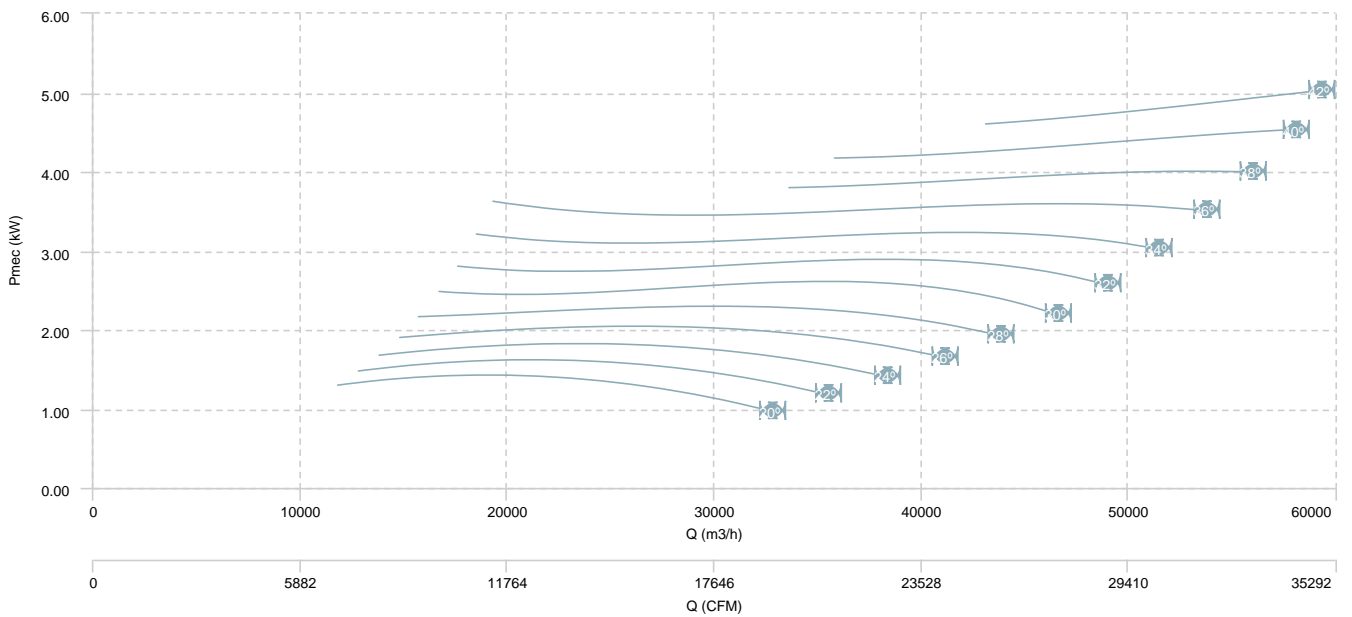

BOX HBF 112 T6 (A3:8) F400

AIR FLOW - PRESSURE

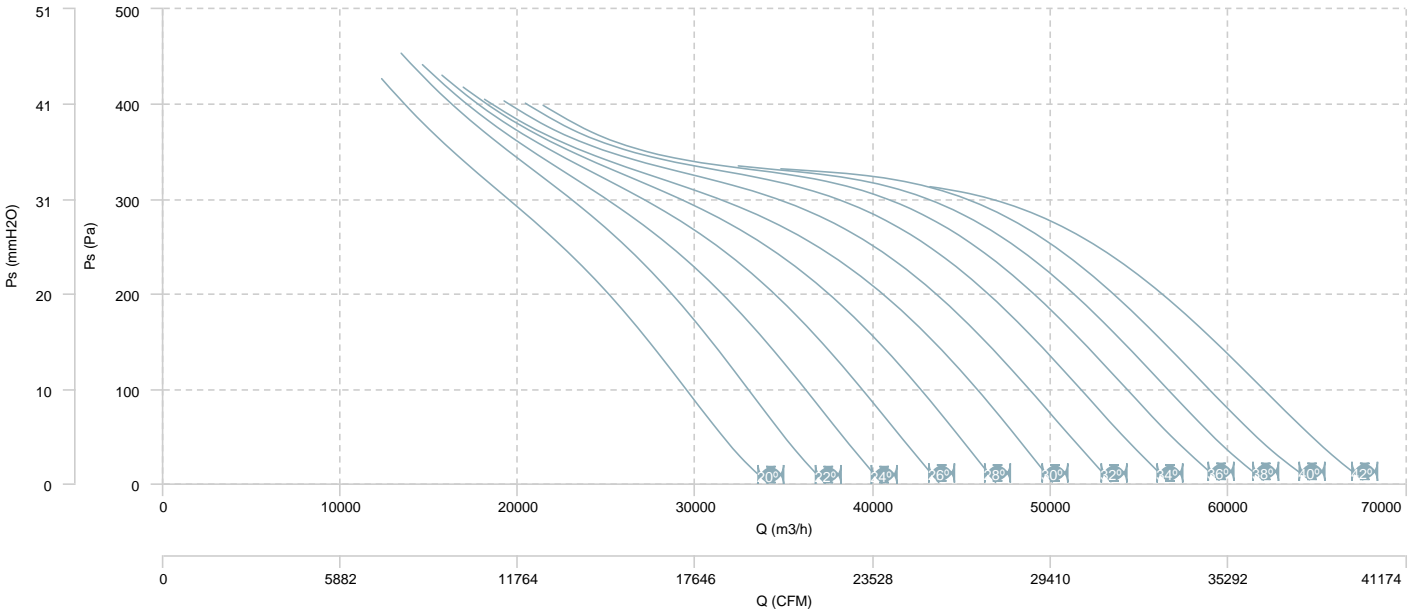

AIR FLOW - MECHANICAL POWER

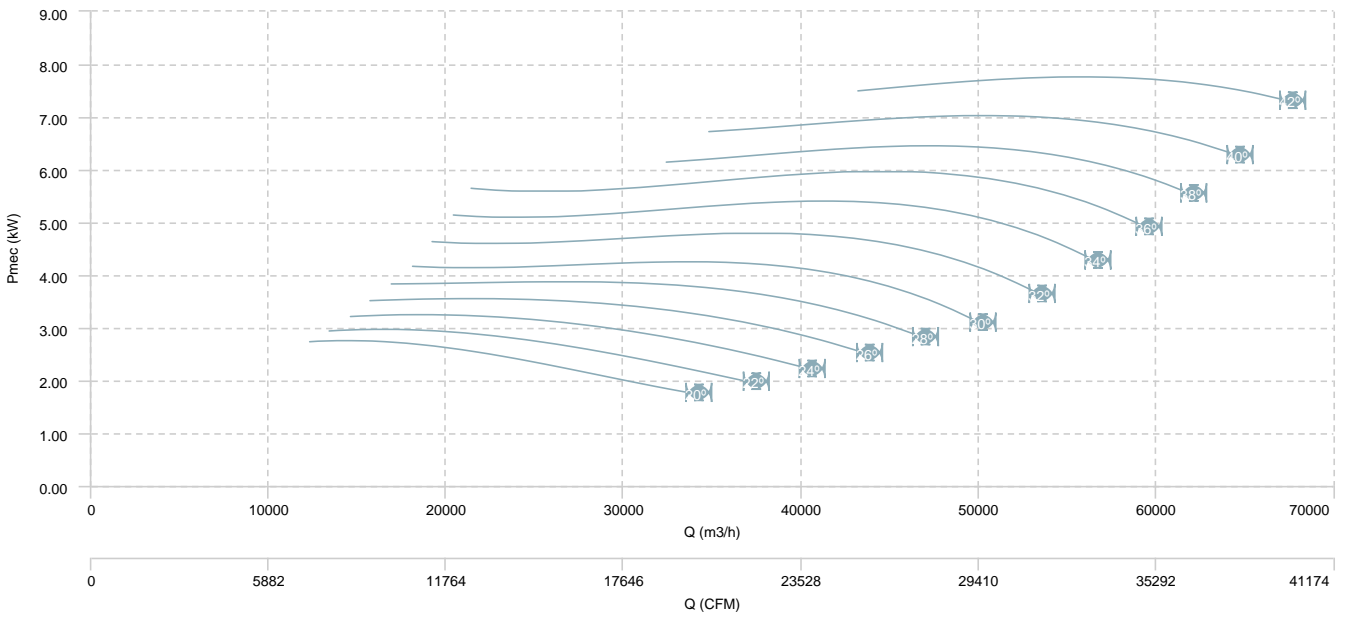

BOX HBF 112 T4/T8 (A3:4) F400

AIR FLOW - PRESSURE (4 poles)

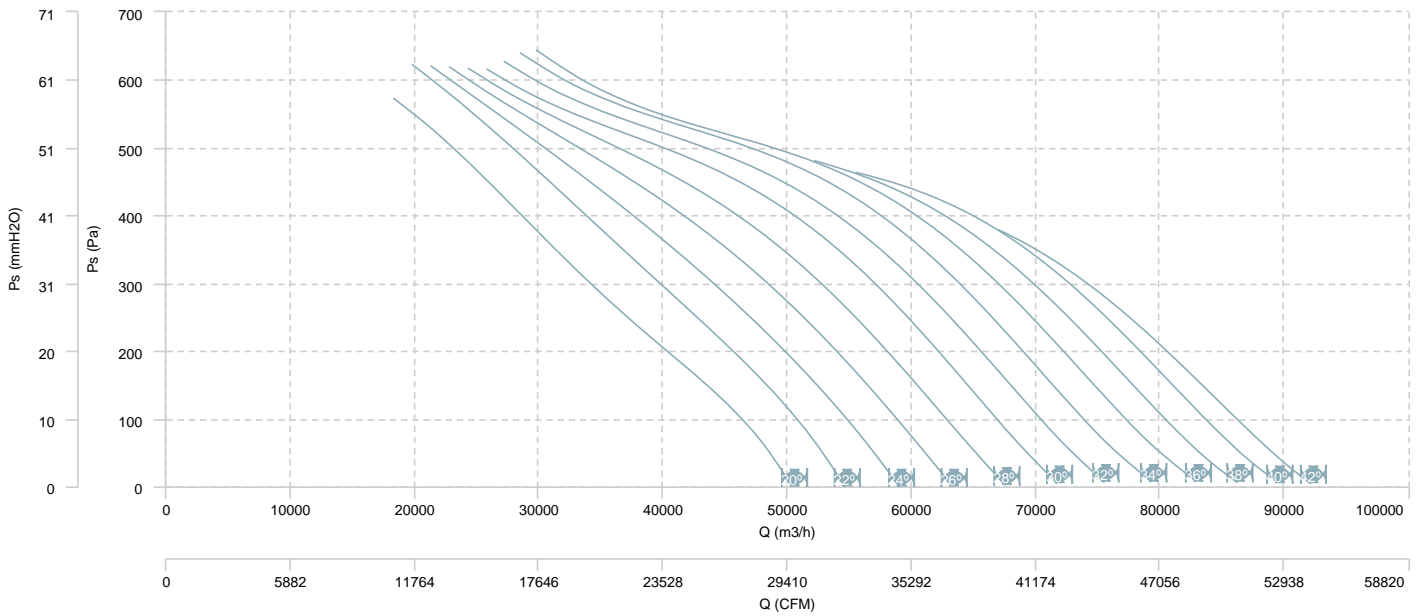

AIR FLOW - MECHANICAL POWER (4 poles)

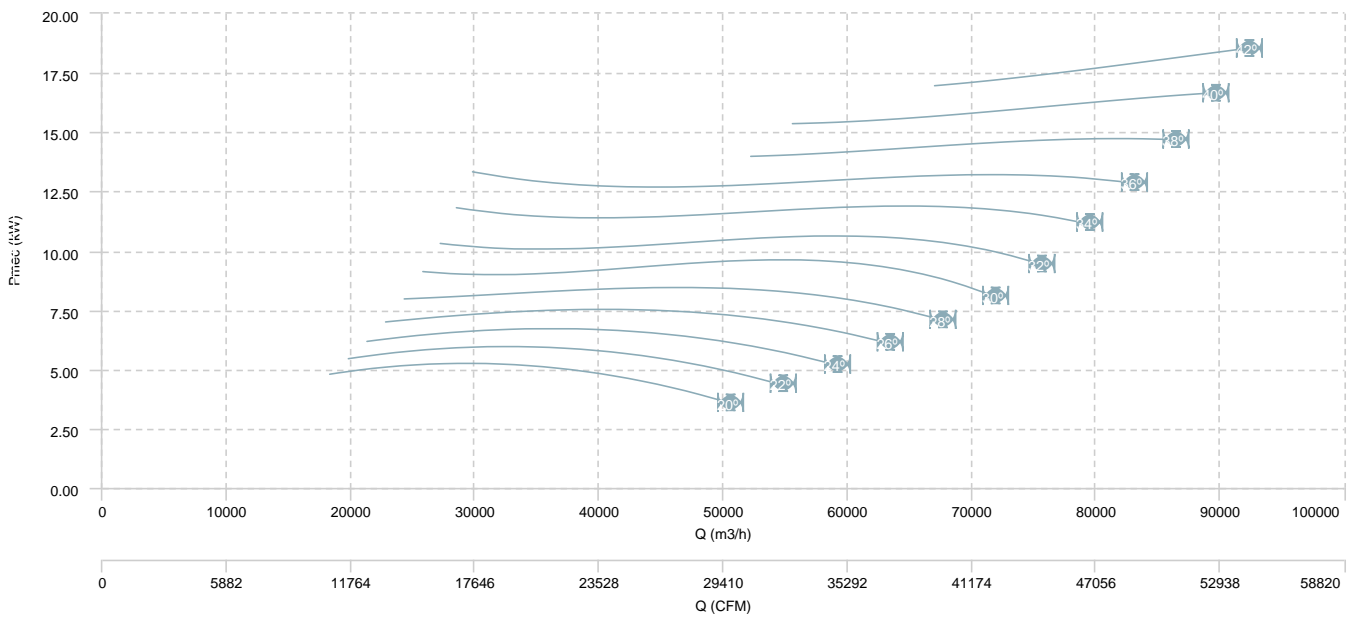

BOX HBF 112 T4/T8 (A3:4) F400

AIR FLOW - PRESSURE (8 poles)

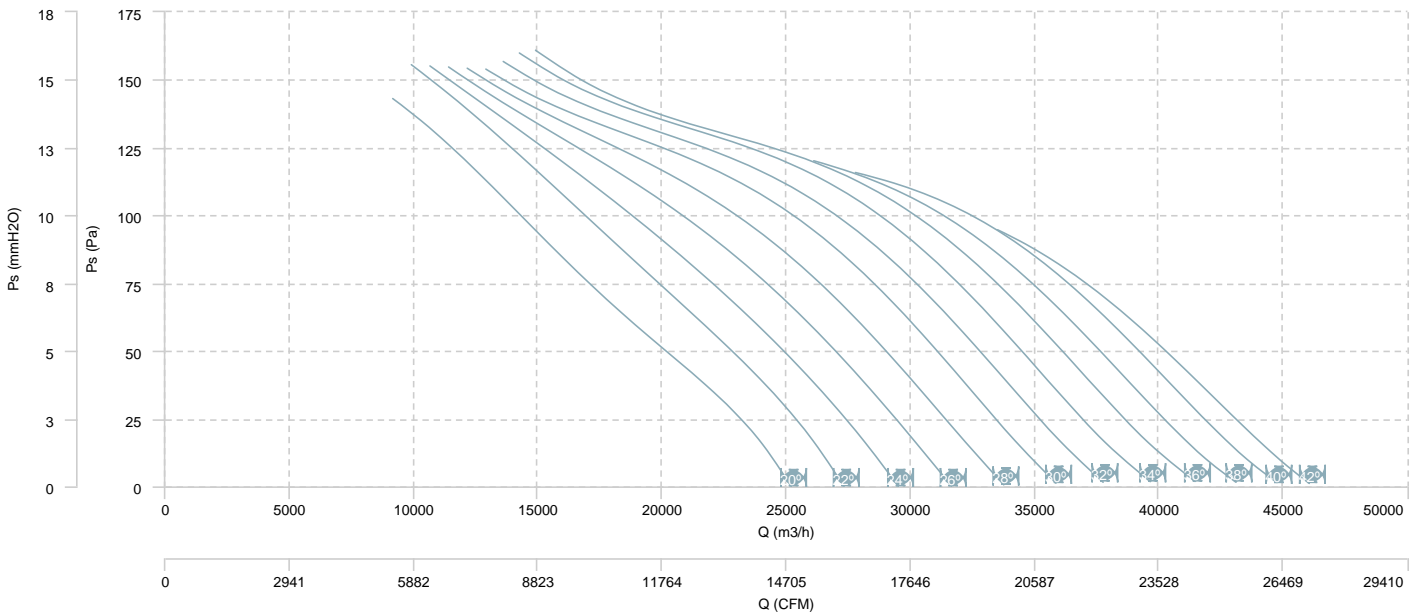

AIR FLOW - MECHANICAL POWER (8 poles)

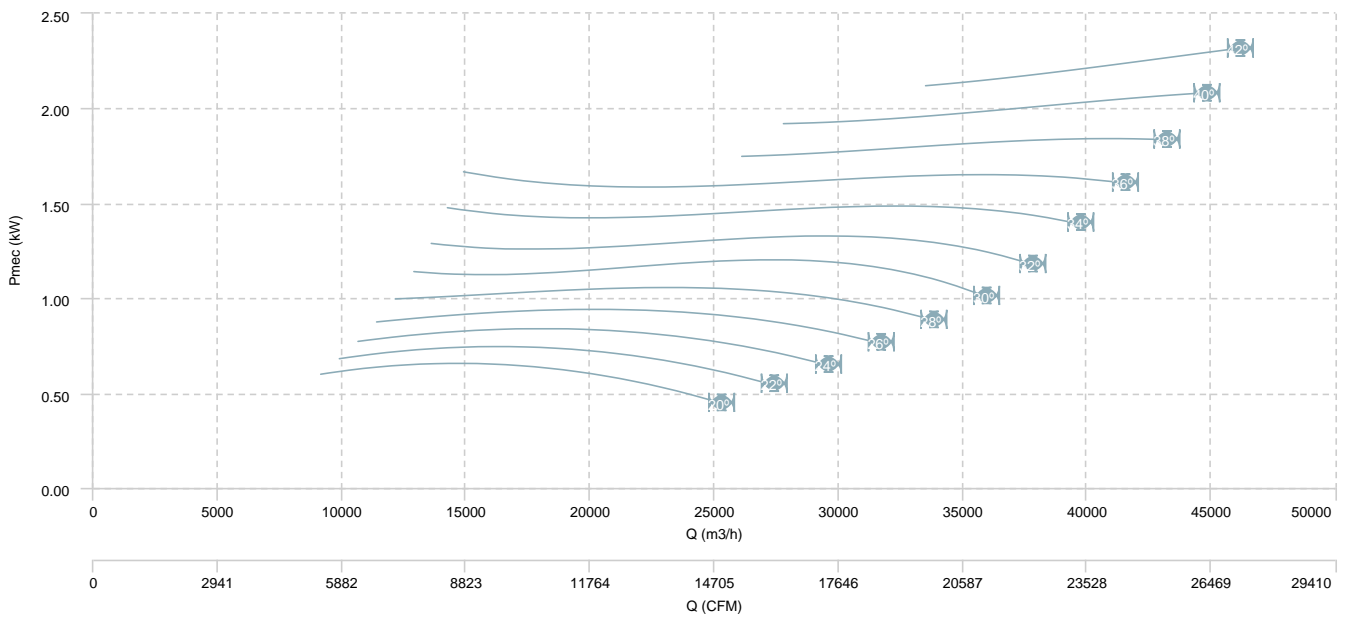

BOX HBF 112 T4/T8 (A3:8) F400

AIR FLOW - PRESSURE (4 poles)

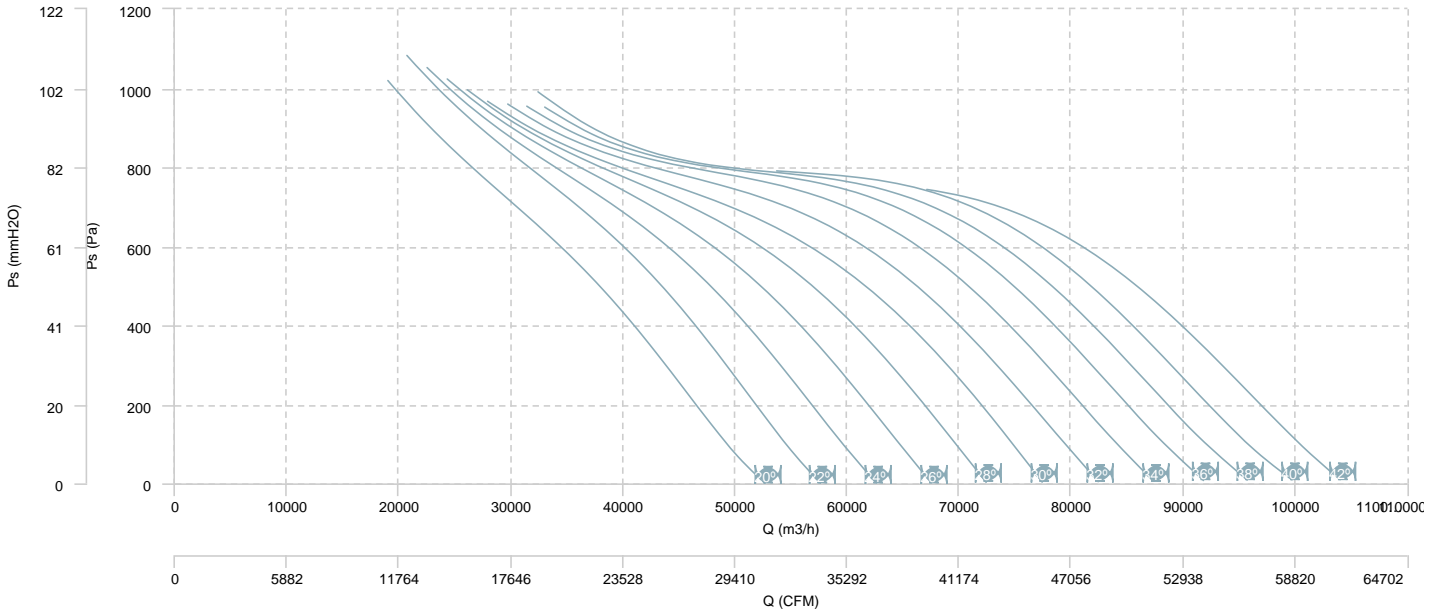

AIR FLOW - MECHANICAL POWER (4 poles)

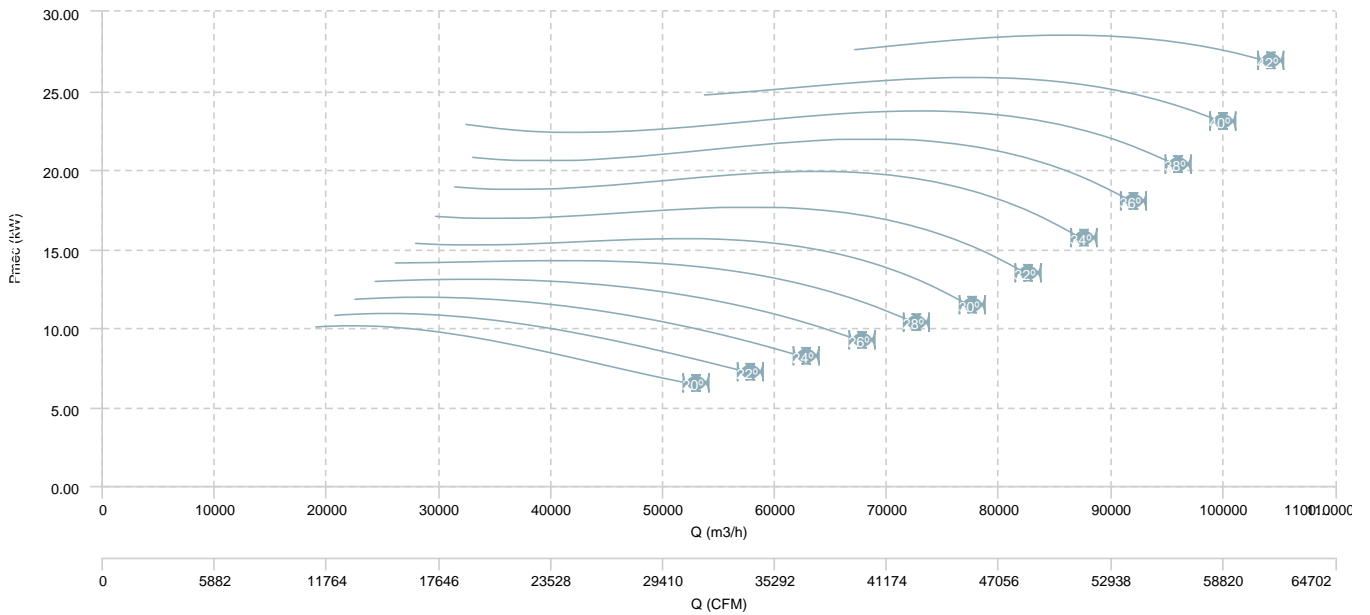

BOX HBF 112 T4/T8 (A3:8) F400

AIR FLOW - PRESSURE (8 poles)

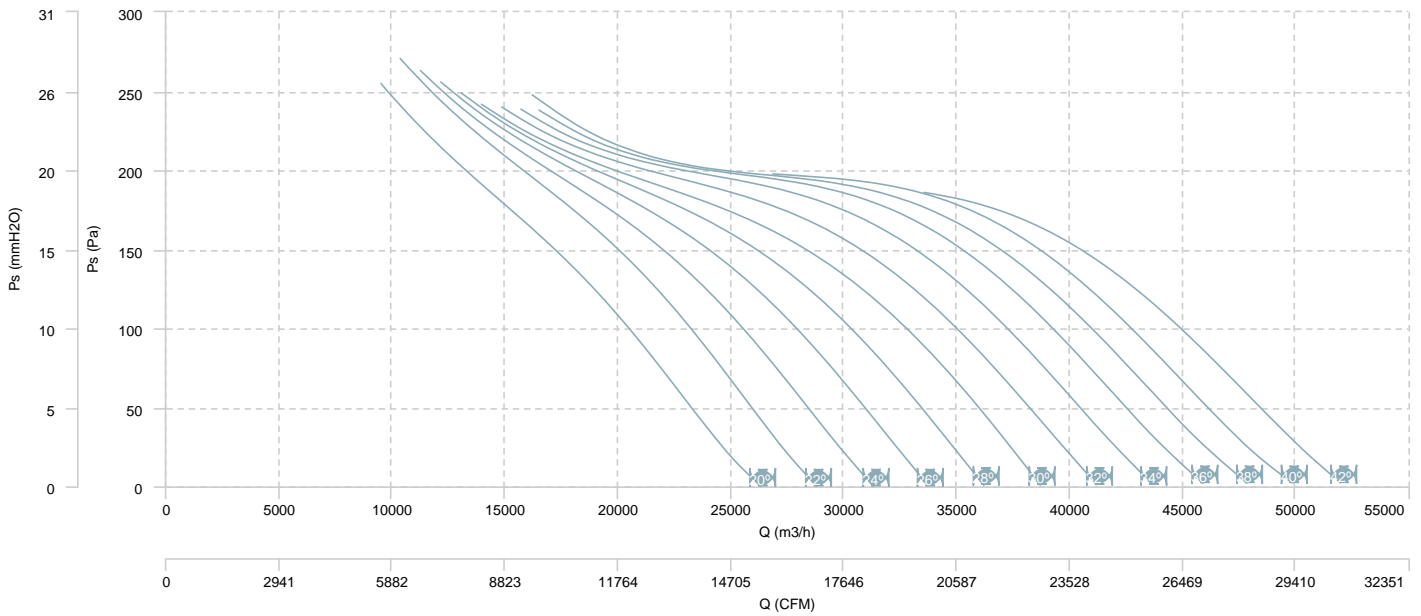

AIR FLOW - MECHANICAL POWER (8 poles)

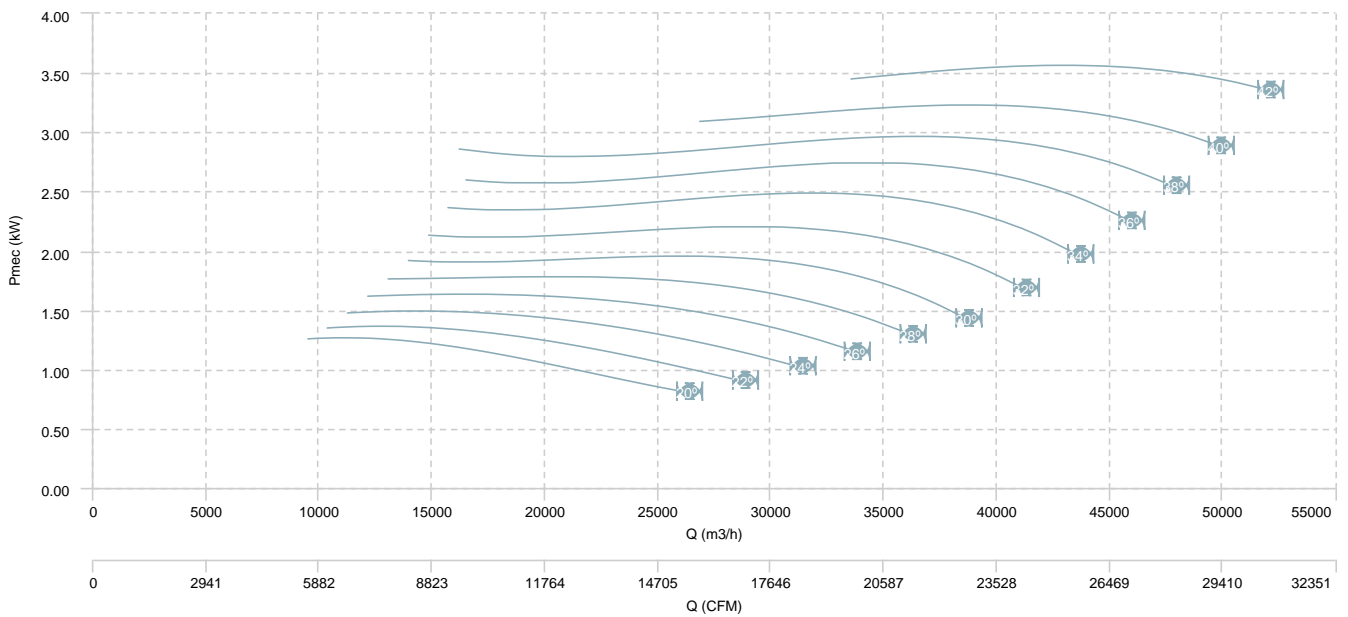

BOX HBF 125 T4 (A3:4) F400

**AIR FLOW - PRESSURE**

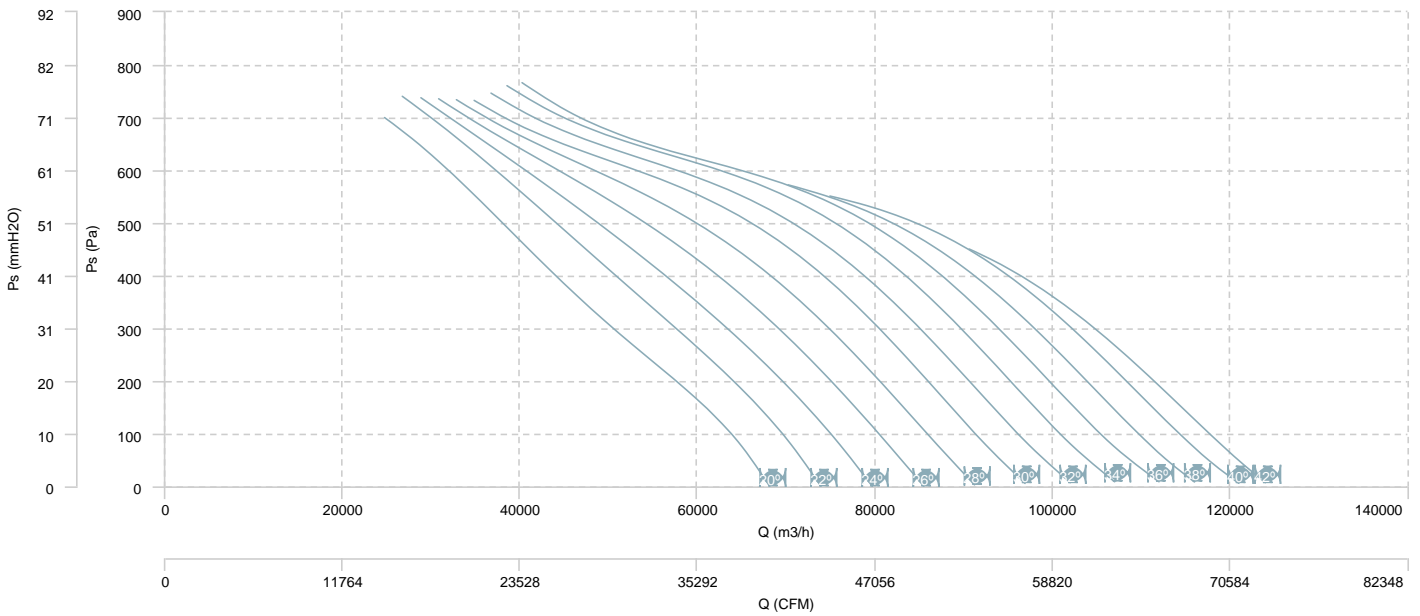

**AIR FLOW - MECHANICAL POWER**

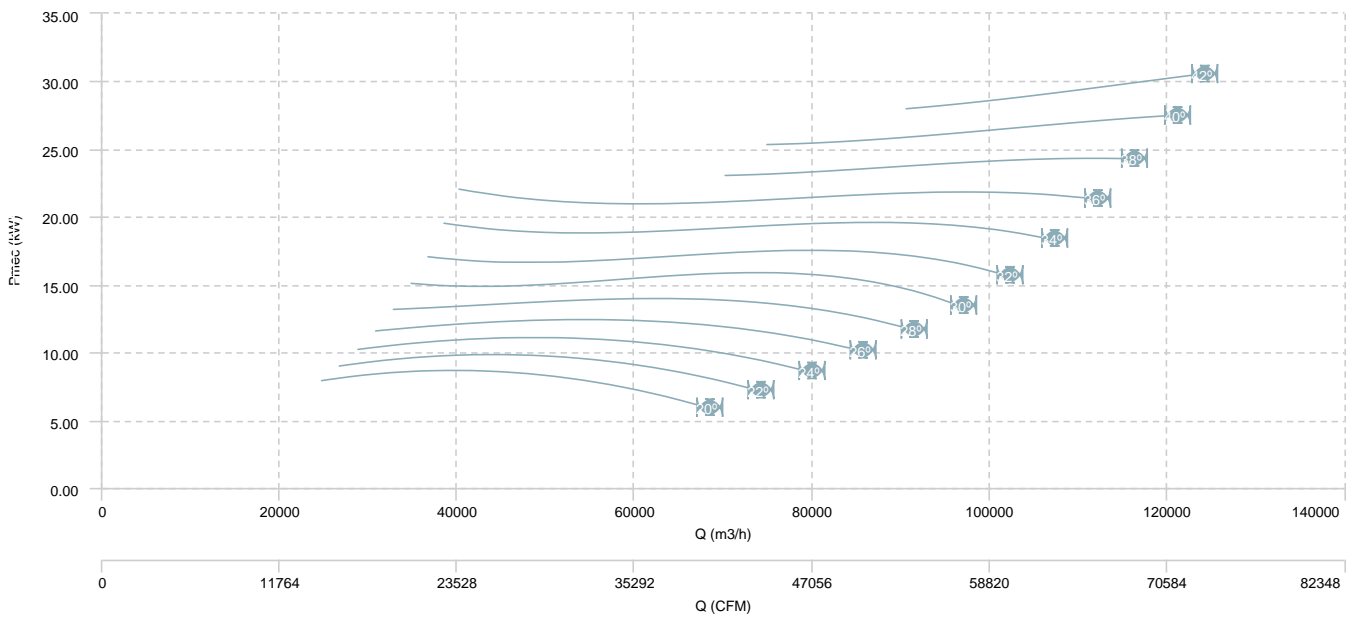



BOX HBF 125 T4 (A3:8) F400

AIR FLOW - PRESSURE

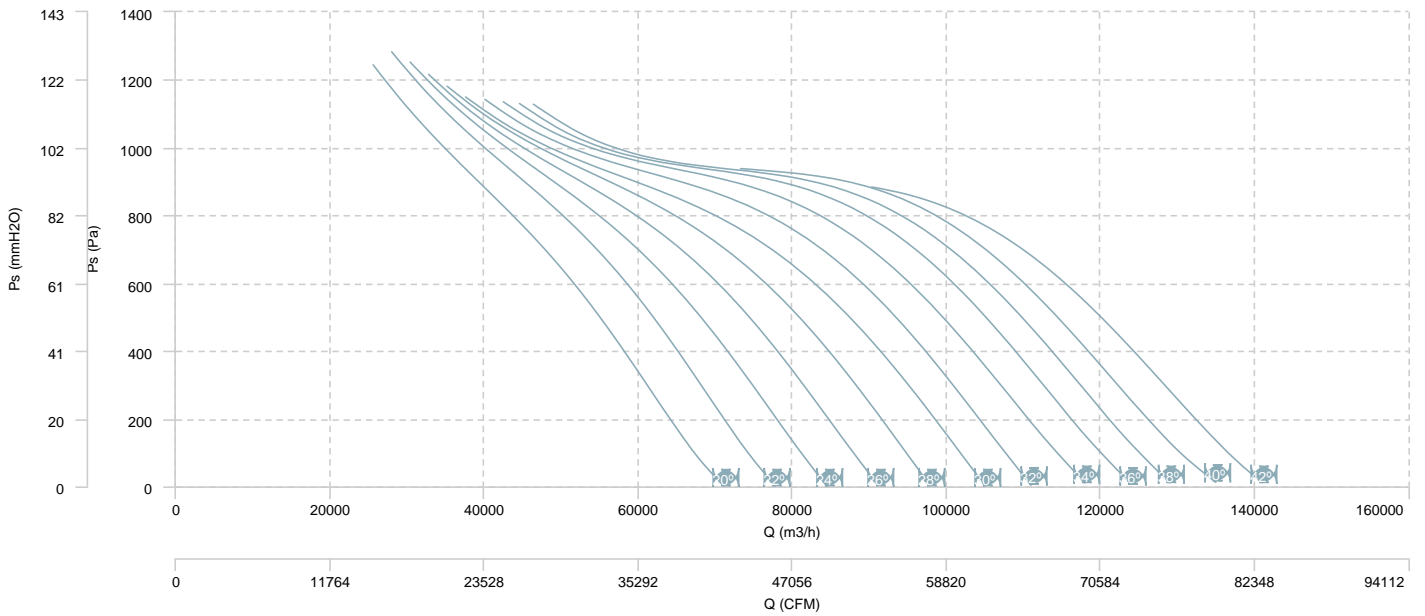

AIR FLOW - MECHANICAL POWER

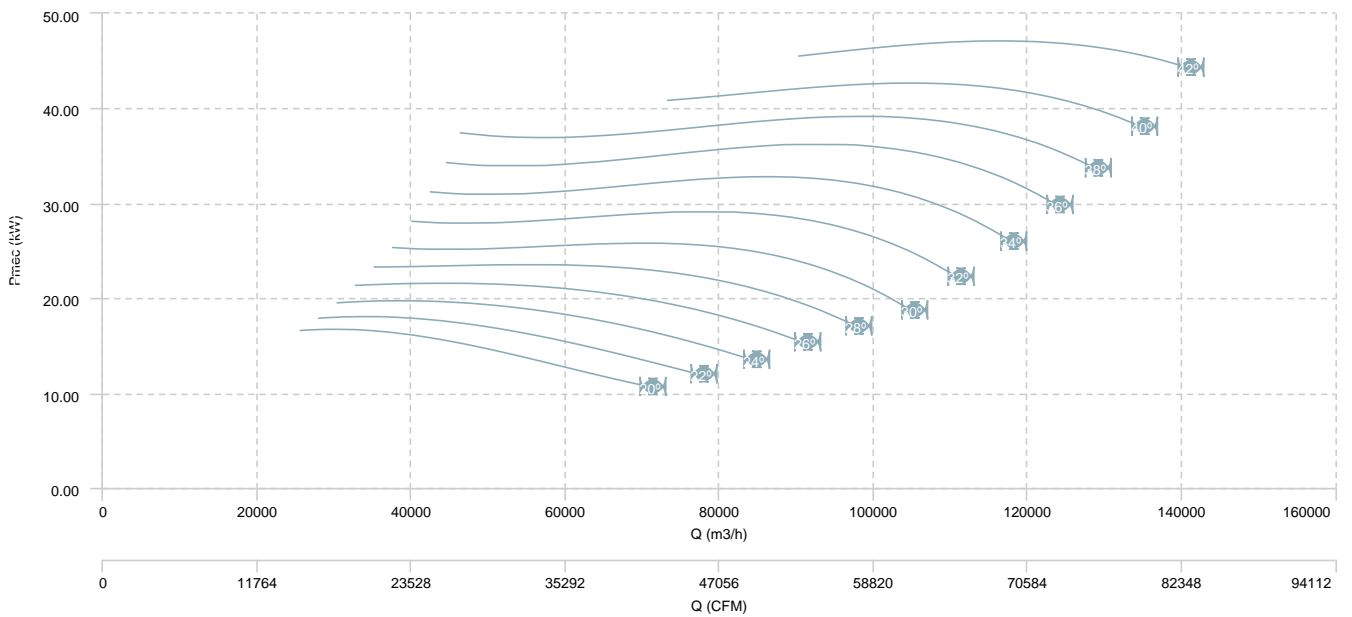

BOX HBF 125 T6 (A3:4) F400

AIR FLOW - PRESSURE

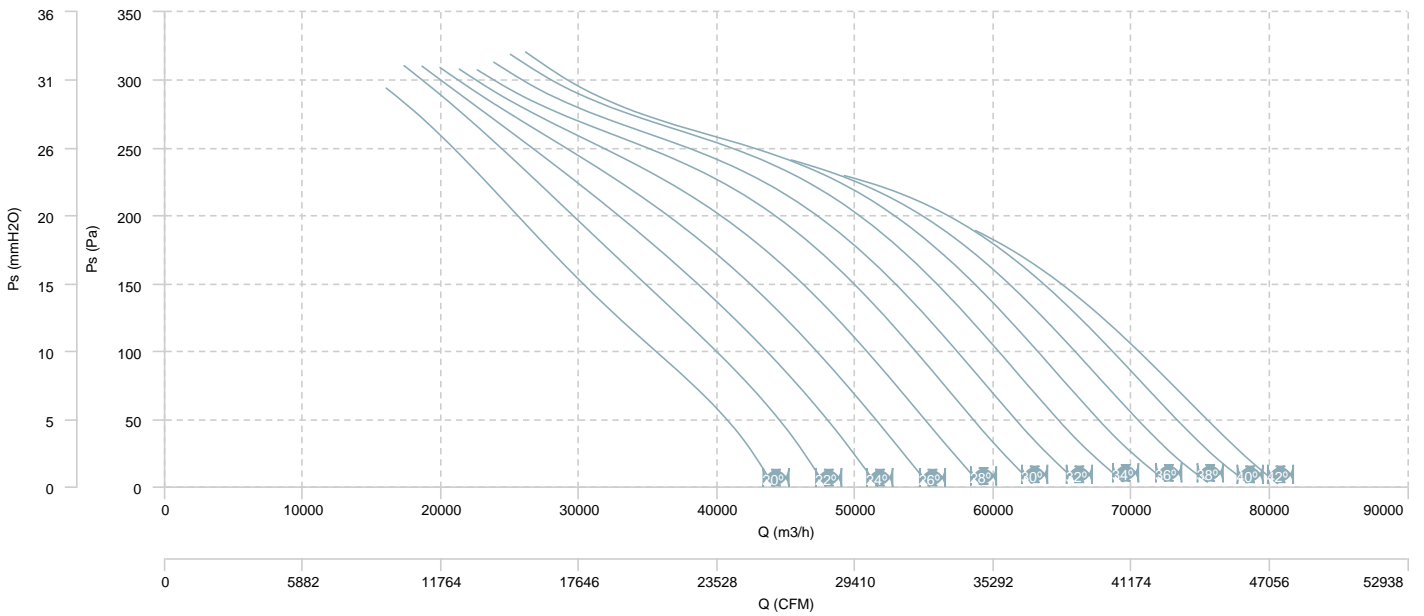

AIR FLOW - MECHANICAL POWER

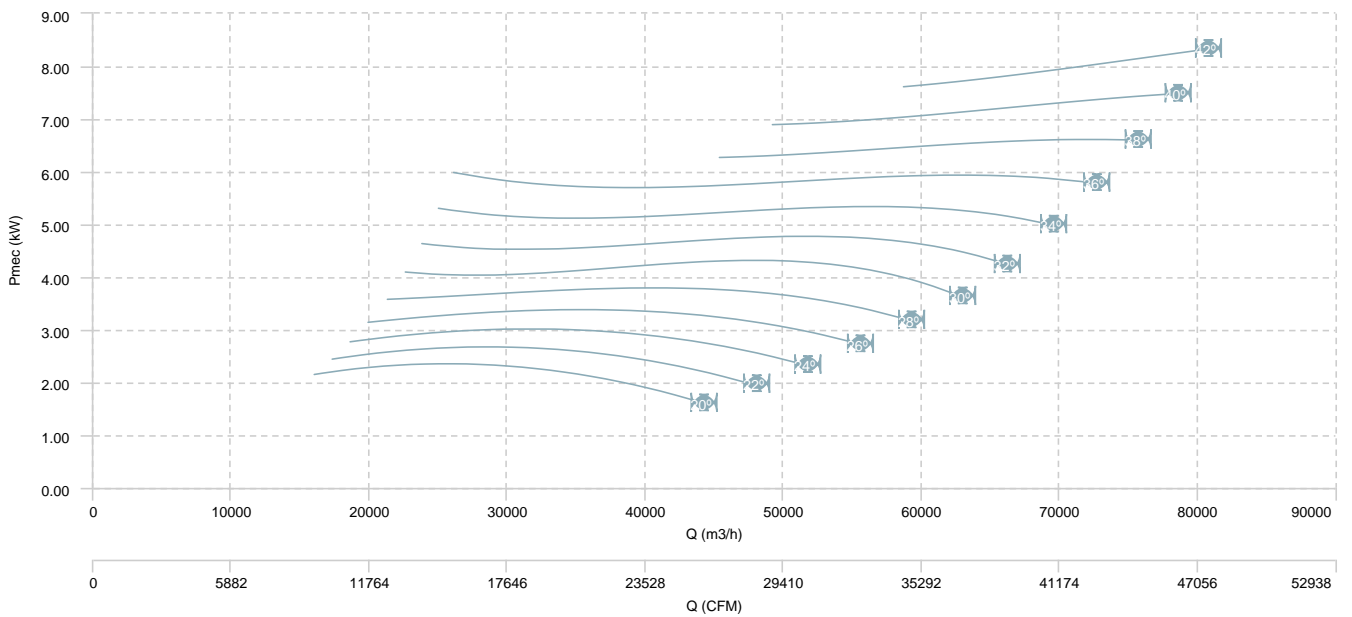

BOX HBF 125 T6 (A3:8) F400

AIR FLOW - PRESSURE

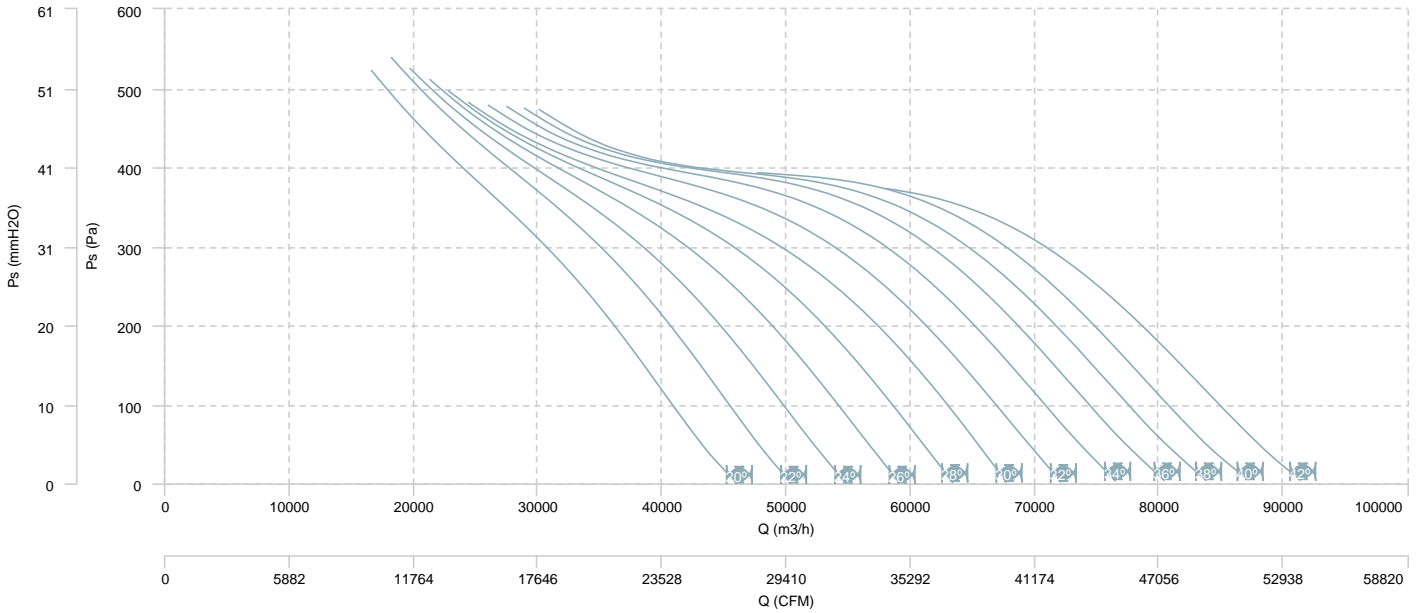

AIR FLOW - MECHANICAL POWER

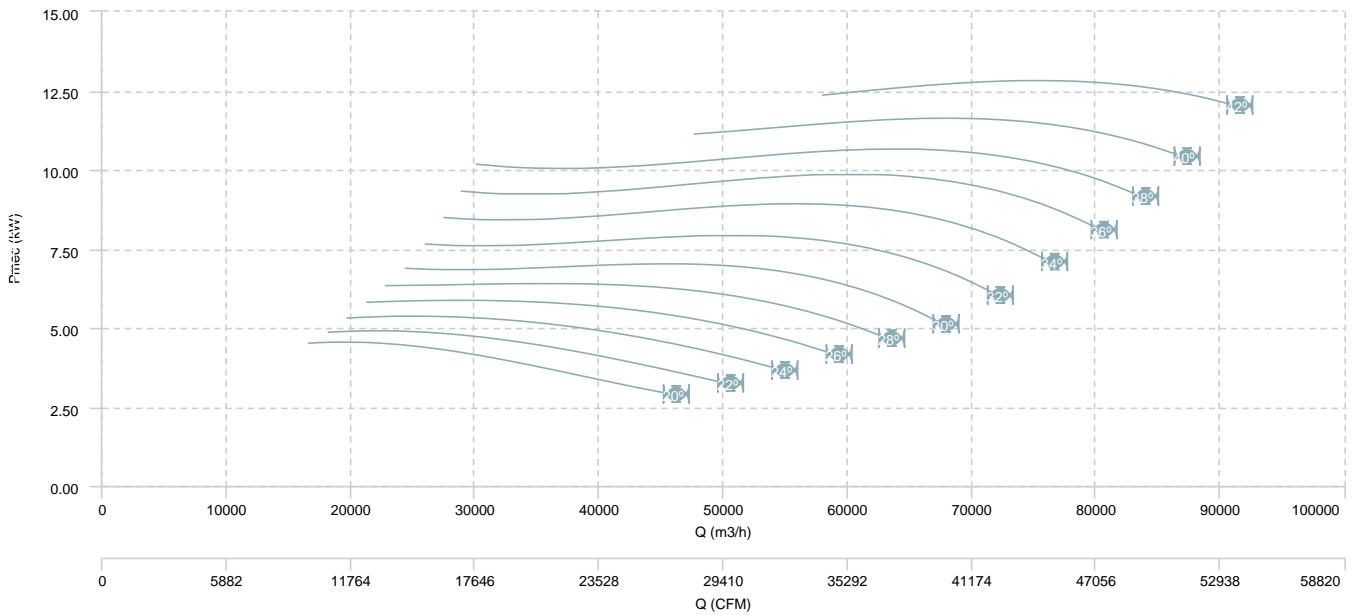

BOX HBF 125 T4/T8 (A3:4) F400

AIR FLOW - PRESSURE (4 poles)

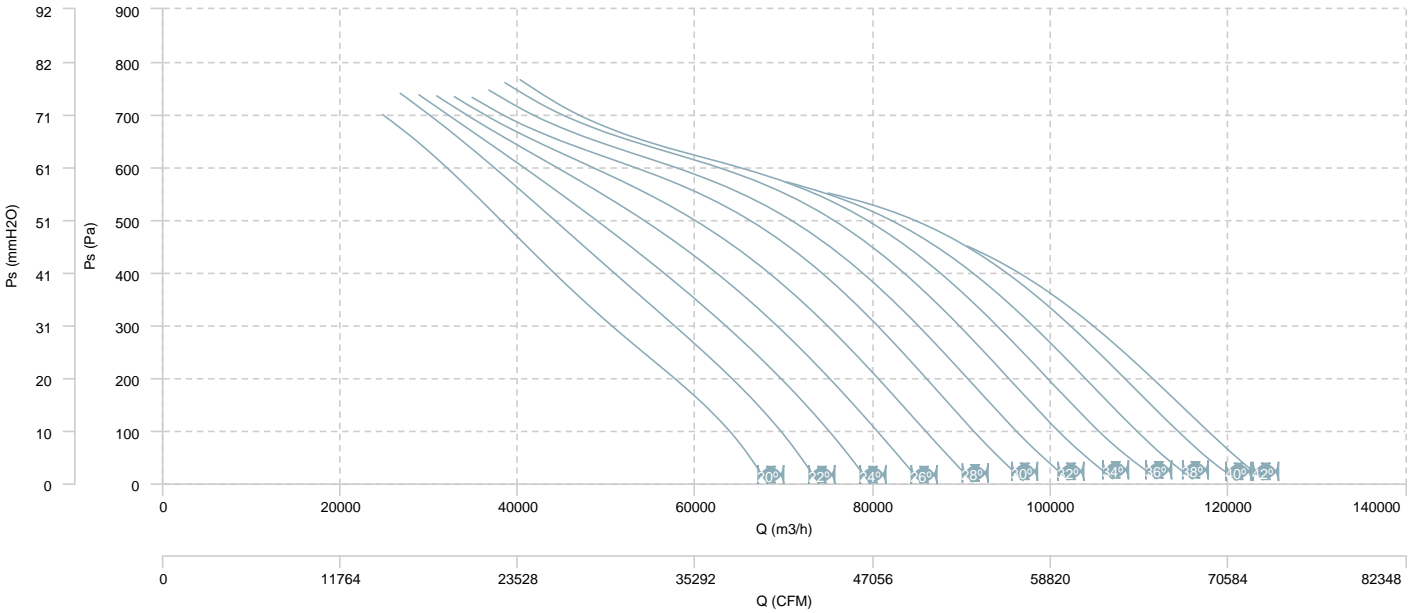

AIR FLOW - MECHANICAL POWER (4 poles)

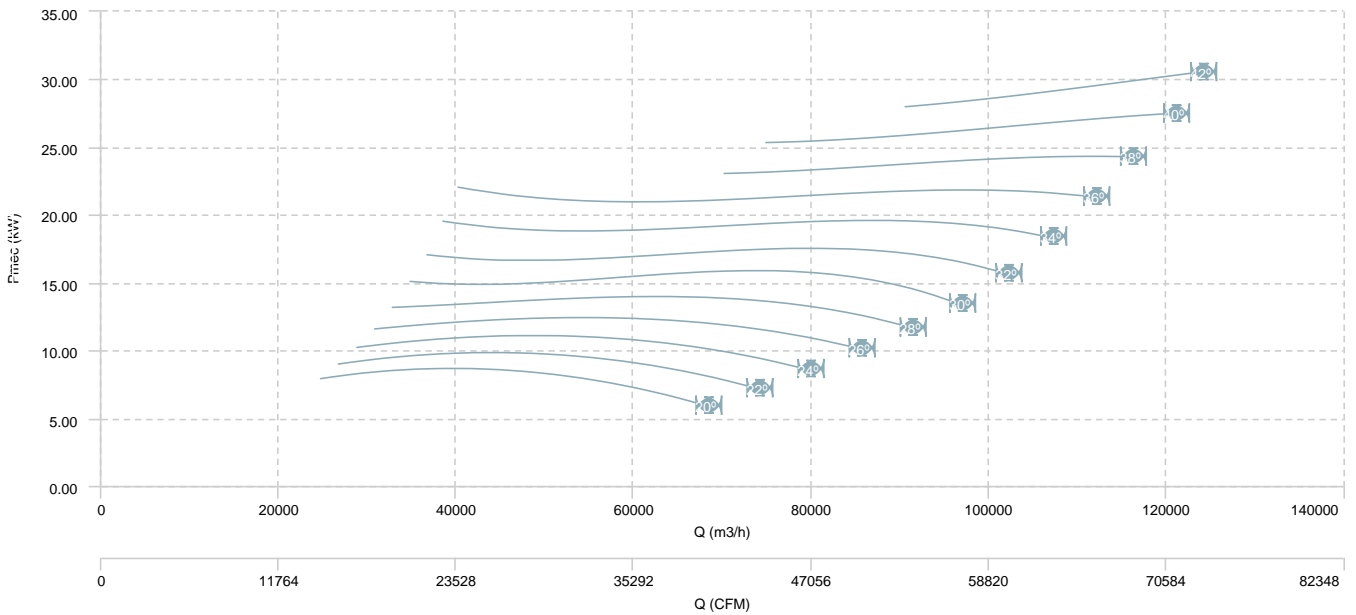

BOX HBF 125 T4/T8 (A3:4) F400

AIR FLOW - PRESSURE (8 poles)

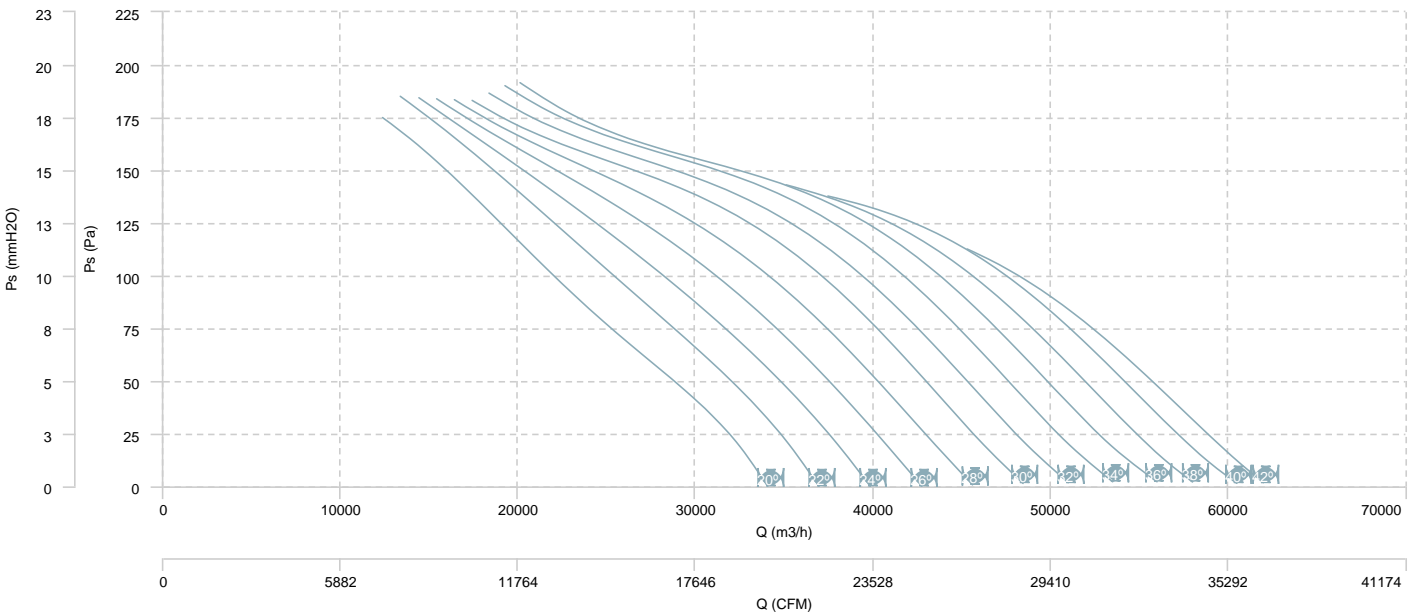

AIR FLOW - MECHANICAL POWER (8 poles)

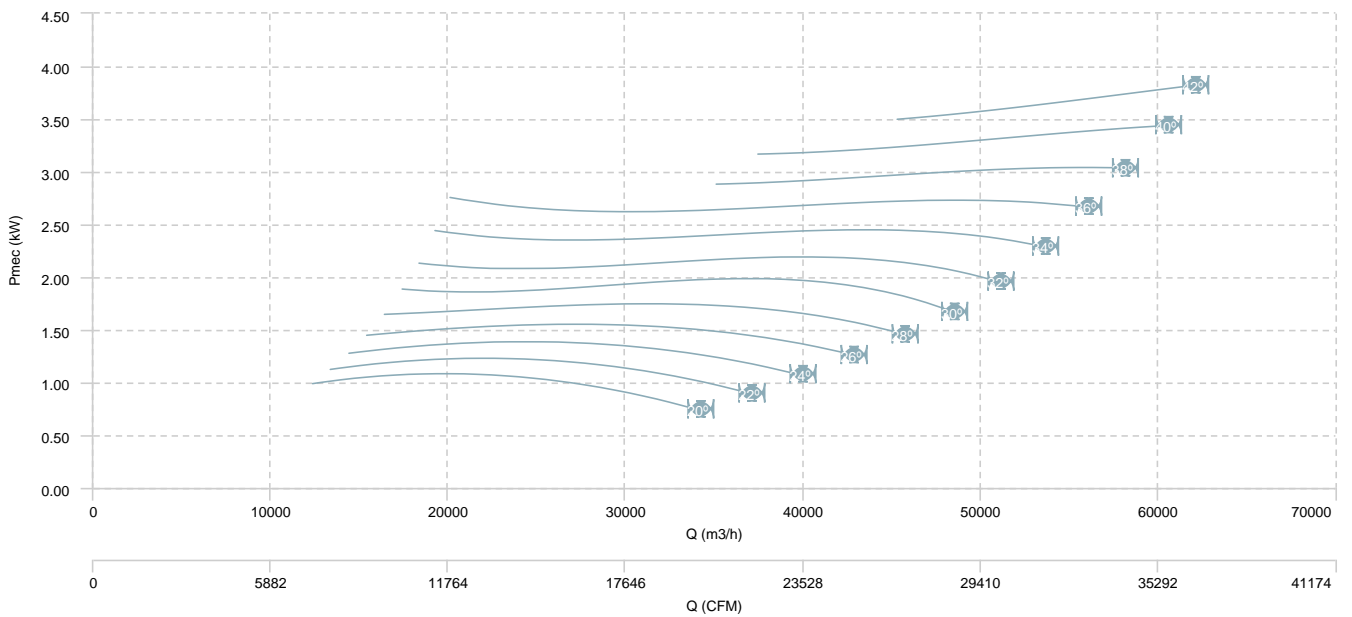

BOX HBF 125 T4/T8 (A3:8) F400

AIR FLOW - PRESSURE (4 poles)

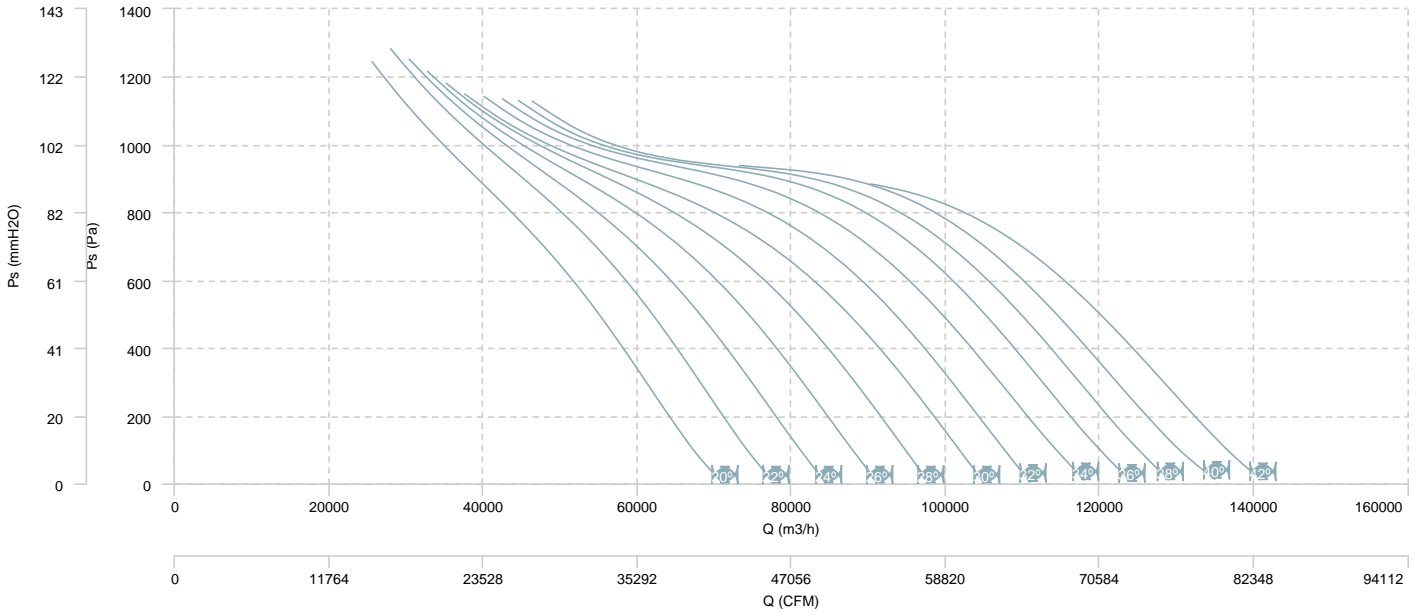

AIR FLOW - MECHANICAL POWER (4 poles)

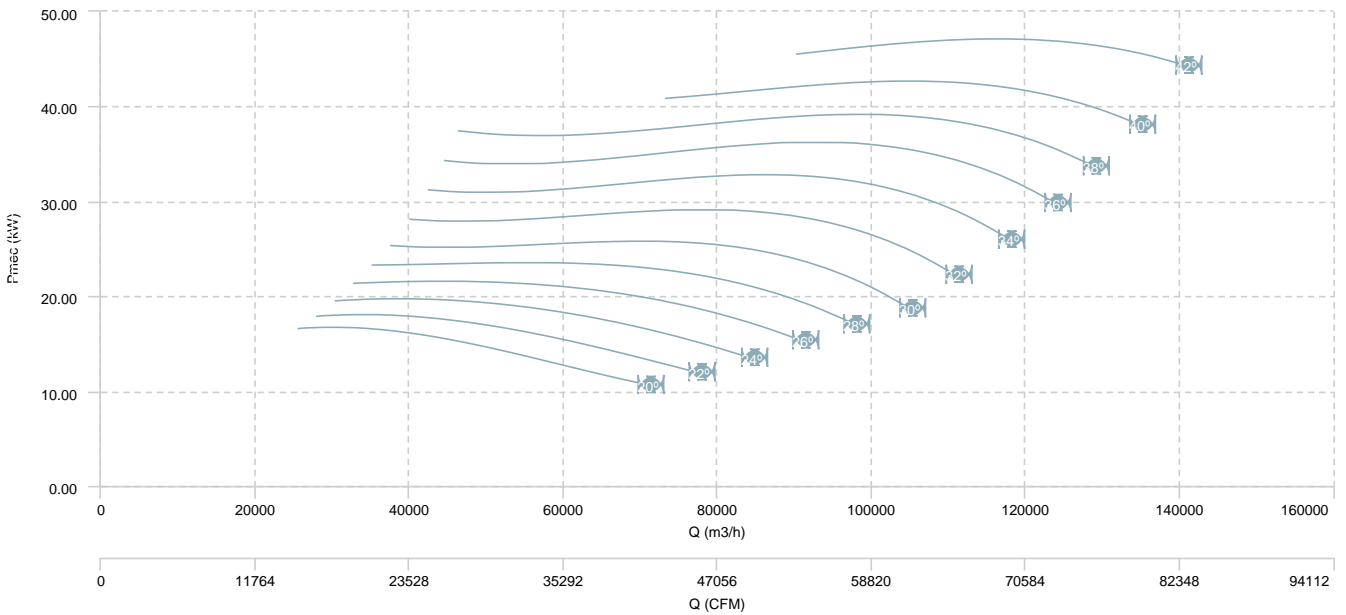

BOX HBF 125 T4/T8 (A3:8) F400

AIR FLOW - PRESSURE (8 poles)

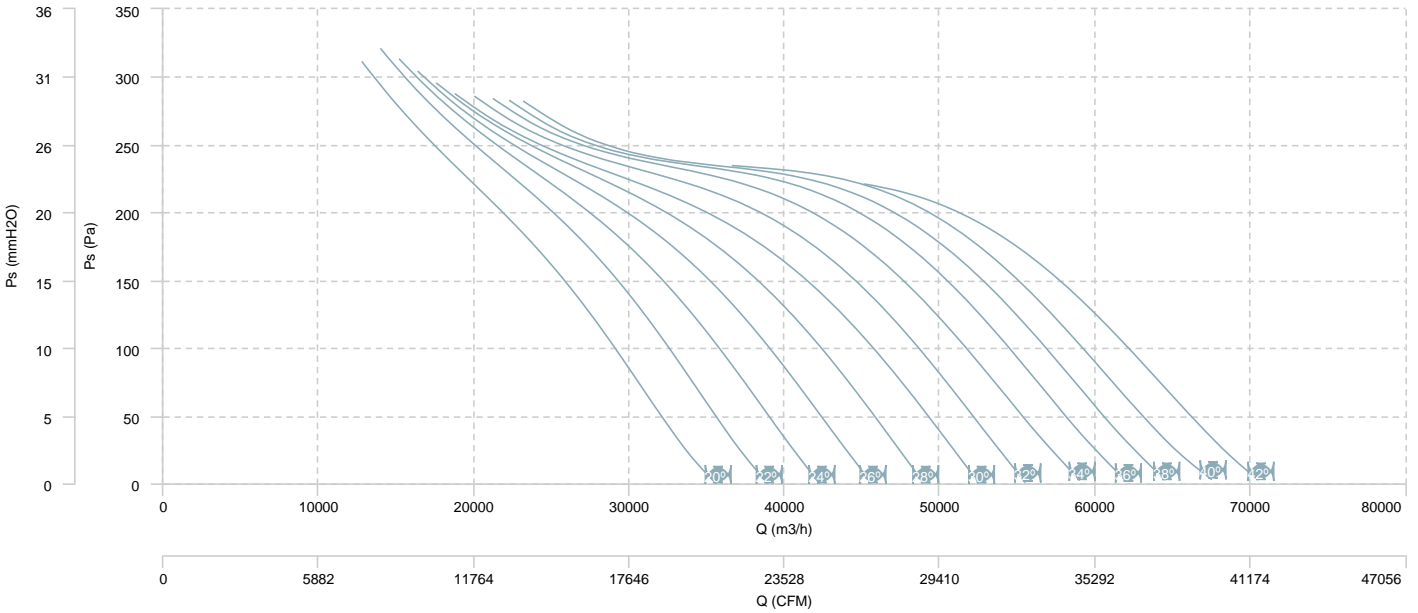

AIR FLOW - MECHANICAL POWER (8 poles)

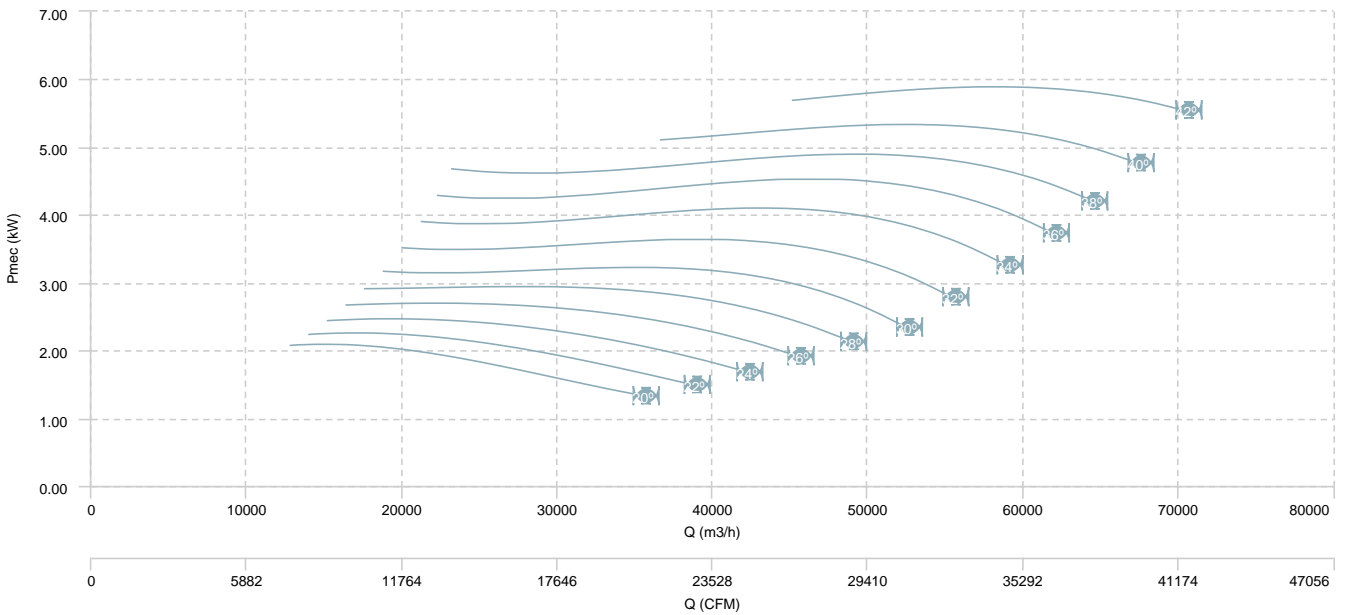

## Sound data

### Sound / 4 poles

Sound power Lw dB (A)										
Model		63 Hz	125 Hz	250 Hz	500 Hz	1000 Hz	2000 Hz	4000 Hz	8000 Hz	Total
BOX HBF 45 T4 (A5:6) F400 (20º)	Inlet	48	53	60	67	69	70	69	60	75
BOX HBF 45 T4 (A5:6) F400 (25º)	Inlet	49	55	62	67	69	70	70	61	75
BOX HBF 45 T4 (A5:6) F400 (27º)	Inlet	49	57	64	67	69	69	71	61	76
BOX HBF 45 T4 (A5:6) F400 (30º)	Inlet	49	58	65	67	70	69	71	61	76
BOX HBF 45 T4 (A5:6) F400 (33º)	Inlet	48	57	65	66	68	67	70	60	75
BOX HBF 45 T4 (A5:6) F400 (35º)	Inlet	46	57	65	65	67	66	69	60	74
BOX HBF 45 T4 (A5:6) F400 (37º)	Inlet	47	57	65	66	68	67	70	60	75
BOX HBF 45 T4 (A5:6) F400 (40º)	Inlet	48	58	65	67	70	69	71	61	76
BOX HBF 45 T4 (A5:6) F400 (43º)	Inlet	48	57	64	67	70	70	71	61	76
BOX HBF 45 T4 (A5:6) F400 (45º)	Inlet	50	57	63	67	72	72	72	61	77
BOX HBF 50 T4 (A5:6) F400 (20º)	Inlet	47	54	62	68	74	72	72	63	78
BOX HBF 50 T4 (A5:6) F400 (25º)	Inlet	45	52	60	66	70	69	70	61	76
BOX HBF 50 T4 (A5:6) F400 (27º)	Inlet	42	51	58	64	67	66	68	58	73
BOX HBF 50 T4 (A5:6) F400 (30º)	Inlet	41	50	57	63	65	65	67	57	72
BOX HBF 50 T4 (A5:6) F400 (33º)	Inlet	43	52	58	64	65	65	68	59	72
BOX HBF 50 T4 (A5:6) F400 (35º)	Inlet	45	54	60	65	65	66	69	61	73
BOX HBF 50 T4 (A5:6) F400 (37º)	Inlet	46	55	62	66	67	67	71	63	75
BOX HBF 50 T4 (A5:6) F400 (40º)	Inlet	48	56	64	68	69	69	73	66	77
BOX HBF 50 T4 (A5:6) F400 (43º)	Inlet	47	56	64	68	69	70	73	65	77
BOX HBF 50 T4 (A5:6) F400 (45º)	Inlet	47	55	64	67	70	71	73	65	77
BOX HBF 56 T4 (A5:6) F400 (20º)	Inlet	63	70	75	76	77	75	73	65	83
BOX HBF 56 T4 (A5:6) F400 (25º)	Inlet	50	59	64	70	72	72	73	64	79
BOX HBF 56 T4 (A5:6) F400 (30º)	Inlet	59	69	76	78	78	76	74	66	84
BOX HBF 56 T4 (A5:6) F400 (35º)	Inlet	47	59	64	70	71	72	73	65	78
BOX HBF 56 T4 (A5:6) F400 (40º)	Inlet	53	66	76	82	81	75	73	64	86
BOX HBF 56 T4 (A5:6) F400 (45º)	Inlet	57	70	85	91	88	77	73	64	93
BOX HBF 63 T4 (A5:6) F400 (20º)	Inlet	66	73	78	79	80	77	76	69	86
BOX HBF 63 T4 (A5:6) F400 (25º)	Inlet	51	60	65	70	74	73	73	67	80
BOX HBF 63 T4 (A5:6) F400 (30º)	Inlet	54	62	72	79	77	76	76	69	84
BOX HBF 63 T4 (A5:6) F400 (35º)	Inlet	50	62	67	71	75	74	76	69	81
BOX HBF 63 T4 (A5:6) F400 (40º)	Inlet	51	63	74	86	83	78	76	68	89
BOX HBF 63 T4 (A5:6) F400 (45º)	Inlet	52	63	79	97	89	81	76	68	97
BOX HBF 71 T4 (A5:6) F400 (20º)	Inlet	68	75	80	82	82	80	79	72	89
BOX HBF 71 T4 (A5:6) F400 (25º)	Inlet	55	65	71	75	78	79	79	70	85
BOX HBF 71 T4 (A5:6) F400 (30º)	Inlet	57	65	72	78	79	78	78	69	84



Sound power Lw dB (A)											
Model		63 Hz	125 Hz	250 Hz	500 Hz	1000 Hz	2000 Hz	4000 Hz	8000 Hz	Total	
BOX HBF 71 T4 (A5:6) F400 (35°)	Inlet	50	62	67	72	75	76	77	68	81	
BOX HBF 71 T4 (A5:6) F400 (40°)	Inlet	54	65	80	89	85	80	78	69	92	
BOX HBF 71 T4 (A5:6) F400 (45°)	Inlet	58	67	89	102	93	84	80	69	102	
BOX HBF 80 T4 (A5:6) F400 (20°)	Inlet	71	78	83	85	85	83	82	75	91	
BOX HBF 80 T4 (A5:6) F400 (25°)	Inlet	58	65	71	76	78	78	79	71	85	
BOX HBF 80 T4 (A5:6) F400 (30°)	Inlet	58	69	76	86	84	82	82	74	90	
BOX HBF 80 T4 (A5:6) F400 (35°)	Inlet	55	67	73	81	86	84	84	75	91	
BOX HBF 80 T4 (A5:6) F400 (40°)	Inlet	56	69	85	90	87	83	81	73	94	
BOX HBF 80 T4 (A5:6) F400 (45°)	Inlet	57	71	94	97	88	83	79	72	99	
BOX HBF 90 T4 (A3:4) F400 (20°)	Inlet	80	81	79	84	85	84	82	76	91	
BOX HBF 90 T4 (A3:4) F400 (22°)	Inlet	84	82	80	83	84	83	82	75	91	
BOX HBF 90 T4 (A3:4) F400 (24°)	Inlet	86	83	81	83	83	82	81	75	92	
BOX HBF 90 T4 (A3:4) F400 (26°)	Inlet	87	84	82	83	82	81	80	74	92	
BOX HBF 90 T4 (A3:4) F400 (28°)	Inlet	88	85	83	83	81	80	80	74	92	
BOX HBF 90 T4 (A3:4) F400 (30°)	Inlet	89	86	84	83	80	79	79	73	93	
BOX HBF 90 T4 (A3:4) F400 (32°)	Inlet	89	86	84	82	80	79	79	73	93	
BOX HBF 90 T4 (A3:4) F400 (34°)	Inlet	88	85	83	81	80	80	78	72	92	
BOX HBF 90 T4 (A3:4) F400 (36°)	Inlet	89	86	84	81	81	80	78	72	93	
BOX HBF 90 T4 (A3:4) F400 (38°)	Inlet	90	87	85	82	82	80	79	74	94	
BOX HBF 90 T4 (A3:4) F400 (40°)	Inlet	91	88	86	83	84	81	80	75	95	
BOX HBF 90 T4 (A3:4) F400 (42°)	Inlet	92	89	87	84	85	82	81	76	96	
BOX HBF 90 T4 (A3:8) F400 (20°)	Inlet	92	94	96	91	90	83	84	76	101	
BOX HBF 90 T4 (A3:8) F400 (22°)	Inlet	92	93	94	90	89	83	84	76	100	
BOX HBF 90 T4 (A3:8) F400 (24°)	Inlet	92	92	92	89	88	84	84	76	99	
BOX HBF 90 T4 (A3:8) F400 (26°)	Inlet	93	91	90	88	87	84	84	77	98	
BOX HBF 90 T4 (A3:8) F400 (28°)	Inlet	93	89	88	87	86	84	83	77	97	
BOX HBF 90 T4 (A3:8) F400 (30°)	Inlet	91	88	86	86	85	84	83	77	96	
BOX HBF 90 T4 (A3:8) F400 (32°)	Inlet	90	87	85	85	84	83	82	76	95	
BOX HBF 90 T4 (A3:8) F400 (34°)	Inlet	90	87	85	84	84	83	81	75	94	
BOX HBF 90 T4 (A3:8) F400 (36°)	Inlet	90	87	85	83	84	83	81	75	94	
BOX HBF 90 T4 (A3:8) F400 (38°)	Inlet	92	89	87	84	84	83	80	75	96	
BOX HBF 90 T4 (A3:8) F400 (40°)	Inlet	94	91	89	84	85	83	80	76	97	
BOX HBF 90 T4 (A3:8) F400 (42°)	Inlet	94	91	89	85	85	84	81	76	98	
BOX HBF 100 T4 (A3:4) F400 (20°)	Inlet	63	73	78	85	88	89	90	87	95	
BOX HBF 100 T4 (A3:4) F400 (22°)	Inlet	63	73	79	85	88	89	90	87	95	
BOX HBF 100 T4 (A3:4) F400 (24°)	Inlet	64	73	78	84	88	89	90	86	95	

Sound power Lw dB (A)										
Model		63 Hz	125 Hz	250 Hz	500 Hz	1000 Hz	2000 Hz	4000 Hz	8000 Hz	Total
BOX HBF 100 T4 (A3:4) F400 (26°)	Inlet	64	72	78	84	87	88	90	85	94
BOX HBF 100 T4 (A3:4) F400 (28°)	Inlet	64	72	78	83	87	88	90	84	94
BOX HBF 100 T4 (A3:4) F400 (30°)	Inlet	65	71	78	83	87	88	90	83	94
BOX HBF 100 T4 (A3:4) F400 (32°)	Inlet	65	71	78	83	86	87	89	83	93
BOX HBF 100 T4 (A3:4) F400 (34°)	Inlet	66	70	78	82	85	87	88	82	93
BOX HBF 100 T4 (A3:4) F400 (36°)	Inlet	66	70	78	83	85	87	88	82	93
BOX HBF 100 T4 (A3:4) F400 (38°)	Inlet	65	71	78	83	86	87	89	82	93
BOX HBF 100 T4 (A3:4) F400 (40°)	Inlet	65	72	78	84	87	88	89	83	94
BOX HBF 100 T4 (A3:4) F400 (42°)	Inlet	66	74	80	85	89	89	90	84	95
BOX HBF 100 T4 (A3:8) F400 (20°)	Inlet	69	78	89	99	97	96	97	92	104
BOX HBF 100 T4 (A3:8) F400 (22°)	Inlet	69	77	88	97	96	95	96	91	103
BOX HBF 100 T4 (A3:8) F400 (24°)	Inlet	69	76	86	94	94	94	95	90	101
BOX HBF 100 T4 (A3:8) F400 (26°)	Inlet	69	76	85	92	93	93	94	89	100
BOX HBF 100 T4 (A3:8) F400 (28°)	Inlet	69	76	84	90	93	92	93	88	99
BOX HBF 100 T4 (A3:8) F400 (30°)	Inlet	69	76	83	88	92	92	93	87	98
BOX HBF 100 T4 (A3:8) F400 (32°)	Inlet	68	76	81	87	90	91	92	86	97
BOX HBF 100 T4 (A3:8) F400 (34°)	Inlet	68	75	80	85	89	90	91	85	96
BOX HBF 100 T4 (A3:8) F400 (36°)	Inlet	67	74	79	84	88	90	91	84	96
BOX HBF 100 T4 (A3:8) F400 (38°)	Inlet	68	75	80	85	89	91	91	85	96
BOX HBF 100 T4 (A3:8) F400 (40°)	Inlet	68	76	81	86	89	91	92	86	97
BOX HBF 100 T4 (A3:8) F400 (42°)	Inlet	69	76	81	86	90	91	92	86	97
BOX HBF 112 T4 (A3:4) F400 (20°)	Inlet	63	75	80	87	91	91	93	89	98

Sound power Lw dB (A)										
Model		63 Hz	125 Hz	250 Hz	500 Hz	1000 Hz	2000 Hz	4000 Hz	8000 Hz	Total
BOX HBF 112 T4 (A3:4) F400 (22°)	Inlet	65	76	81	87	91	92	93	89	99
BOX HBF 112 T4 (A3:4) F400 (24°)	Inlet	66	75	80	87	90	91	93	88	98
BOX HBF 112 T4 (A3:4) F400 (26°)	Inlet	67	75	80	86	90	91	92	87	97
BOX HBF 112 T4 (A3:4) F400 (28°)	Inlet	68	75	80	86	89	90	92	86	96
BOX HBF 112 T4 (A3:4) F400 (30°)	Inlet	68	75	80	85	89	90	91	85	96
BOX HBF 112 T4 (A3:4) F400 (32°)	Inlet	67	74	79	85	88	89	91	84	95
BOX HBF 112 T4 (A3:4) F400 (34°)	Inlet	67	73	79	84	87	89	90	83	95
BOX HBF 112 T4 (A3:4) F400 (36°)	Inlet	68	73	80	84	87	89	90	83	95
BOX HBF 112 T4 (A3:4) F400 (38°)	Inlet	68	74	80	85	88	89	90	84	95
BOX HBF 112 T4 (A3:4) F400 (40°)	Inlet	69	76	81	86	88	90	91	84	96
BOX HBF 112 T4 (A3:4) F400 (42°)	Inlet	69	76	81	86	89	91	91	85	96
BOX HBF 112 T4 (A3:8) F400 (20°)	Inlet	70	79	89	98	98	100	100	94	106
BOX HBF 112 T4 (A3:8) F400 (22°)	Inlet	70	78	88	96	97	99	99	93	104
BOX HBF 112 T4 (A3:8) F400 (24°)	Inlet	70	78	87	94	96	98	98	92	103
BOX HBF 112 T4 (A3:8) F400 (26°)	Inlet	71	78	86	93	95	97	97	91	103
BOX HBF 112 T4 (A3:8) F400 (28°)	Inlet	71	78	85	91	95	96	96	91	102
BOX HBF 112 T4 (A3:8) F400 (30°)	Inlet	71	77	84	90	94	96	96	90	101
BOX HBF 112 T4 (A3:8) F400 (32°)	Inlet	71	78	83	88	93	94	94	88	100
BOX HBF 112 T4 (A3:8) F400 (34°)	Inlet	70	77	82	87	91	93	93	86	98
BOX HBF 112 T4 (A3:8) F400 (36°)	Inlet	70	77	82	87	90	92	92	86	98
BOX HBF 112 T4 (A3:8) F400 (38°)	Inlet	70	77	82	87	91	93	92	86	98
BOX HBF 112 T4 (A3:8) F400 (40°)	Inlet	71	78	83	87	91	93	92	87	99

Sound power Lw dB (A)										
Model		63 Hz	125 Hz	250 Hz	500 Hz	1000 Hz	2000 Hz	4000 Hz	8000 Hz	Total
BOX HBF 112 T4 (A3:8) F400 (42°)	Inlet	70	77	82	88	91	93	92	86	98
BOX HBF 125 T4 (A3:4) F400 (20°)	Inlet	69	82	87	95	99	99	101	98	106
BOX HBF 125 T4 (A3:4) F400 (22°)	Inlet	72	83	88	95	99	100	102	98	106
BOX HBF 125 T4 (A3:4) F400 (24°)	Inlet	72	82	87	93	97	98	100	95	104
BOX HBF 125 T4 (A3:4) F400 (26°)	Inlet	73	81	86	91	95	96	98	93	103
BOX HBF 125 T4 (A3:4) F400 (28°)	Inlet	72	79	84	90	93	95	96	90	101
BOX HBF 125 T4 (A3:4) F400 (30°)	Inlet	71	78	83	88	92	93	94	88	99
BOX HBF 125 T4 (A3:4) F400 (32°)	Inlet	71	78	83	87	91	93	93	87	99
BOX HBF 125 T4 (A3:4) F400 (34°)	Inlet	70	77	82	87	90	92	93	85	98
BOX HBF 125 T4 (A3:4) F400 (36°)	Inlet	71	78	83	87	90	92	93	85	98
BOX HBF 125 T4 (A3:4) F400 (38°)	Inlet	71	78	83	88	90	92	93	86	98
BOX HBF 125 T4 (A3:4) F400 (40°)	Inlet	72	79	84	88	90	93	93	86	99
BOX HBF 125 T4 (A3:4) F400 (42°)	Inlet	72	79	84	89	91	93	93	87	99
BOX HBF 125 T4 (A3:8) F400 (20°)	Inlet	75	83	90	100	105	108	107	102	112
BOX HBF 125 T4 (A3:8) F400 (22°)	Inlet	76	83	90	99	104	107	106	101	111
BOX HBF 125 T4 (A3:8) F400 (24°)	Inlet	75	82	89	97	103	105	105	99	110
BOX HBF 125 T4 (A3:8) F400 (26°)	Inlet	75	82	88	95	101	103	103	97	108
BOX HBF 125 T4 (A3:8) F400 (28°)	Inlet	75	81	88	94	99	102	102	95	107
BOX HBF 125 T4 (A3:8) F400 (30°)	Inlet	74	80	87	93	98	100	101	94	105
BOX HBF 125 T4 (A3:8) F400 (32°)	Inlet	74	80	86	92	96	99	99	91	104
BOX HBF 125 T4 (A3:8) F400 (34°)	Inlet	74	80	86	91	94	96	97	89	102
BOX HBF 125 T4 (A3:8) F400 (36°)	Inlet	74	80	86	90	93	95	95	88	101

Sound power Lw dB (A)										
Model		63 Hz	125 Hz	250 Hz	500 Hz	1000 Hz	2000 Hz	4000 Hz	8000 Hz	Total
BOX HBF 125 T4 (A3:8) F400 (38°)	Inlet	73	80	85	90	93	95	94	88	101
BOX HBF 125 T4 (A3:8) F400 (40°)	Inlet	73	80	85	90	93	95	94	87	100
BOX HBF 125 T4 (A3:8) F400 (42°)	Inlet	73	80	85	90	93	95	93	87	100

**Sound / 6 poles**

Sound power Lw dB (A)										
Model		63 Hz	125 Hz	250 Hz	500 Hz	1000 Hz	2000 Hz	4000 Hz	8000 Hz	Total
BOX HBF 45 T6 (A5:6) F400 (25°)	Inlet	37	42	49	55	54	55	57	50	62
BOX HBF 45 T6 (A5:6) F400 (27°)	Inlet	38	43	50	55	55	56	58	50	63
BOX HBF 45 T6 (A5:6) F400 (30°)	Inlet	40	44	52	55	57	58	59	50	64
BOX HBF 45 T6 (A5:6) F400 (33°)	Inlet	40	44	52	55	58	58	60	50	65
BOX HBF 45 T6 (A5:6) F400 (35°)	Inlet	41	45	53	54	59	59	60	50	65
BOX HBF 45 T6 (A5:6) F400 (37°)	Inlet	42	46	54	56	60	60	61	52	66
BOX HBF 45 T6 (A5:6) F400 (40°)	Inlet	44	47	56	57	61	61	63	54	67
BOX HBF 45 T6 (A5:6) F400 (43°)	Inlet	43	47	55	58	62	62	63	55	68
BOX HBF 45 T6 (A5:6) F400 (45°)	Inlet	43	47	55	58	62	62	63	55	68
BOX HBF 50 T6 (A5:6) F400 (25°)	Inlet	36	43	48	53	55	58	60	52	64
BOX HBF 50 T6 (A5:6) F400 (27°)	Inlet	37	43	49	53	56	58	61	52	64
BOX HBF 50 T6 (A5:6) F400 (30°)	Inlet	39	44	51	55	58	59	62	53	66
BOX HBF 50 T6 (A5:6) F400 (33°)	Inlet	40	45	52	57	59	60	63	54	67
BOX HBF 50 T6 (A5:6) F400 (35°)	Inlet	40	45	52	59	61	62	64	55	68
BOX HBF 50 T6 (A5:6) F400 (37°)	Inlet	41	48	53	59	61	62	64	55	68
BOX HBF 50 T6 (A5:6) F400 (40°)	Inlet	41	48	53	59	61	62	64	55	68
BOX HBF 50 T6 (A5:6) F400 (43°)	Inlet	43	50	55	62	63	64	66	58	71
BOX HBF 50 T6 (A5:6) F400 (45°)	Inlet	44	51	56	64	65	65	67	59	72
BOX HBF 56 T6 (A5:6) F400 (20°)	Inlet	60	67	72	73	74	72	70	62	79
BOX HBF 56 T6 (A5:6) F400 (25°)	Inlet	47	56	61	67	69	69	70	61	75
BOX HBF 56 T6 (A5:6) F400 (30°)	Inlet	55	65	72	74	75	73	71	63	80
BOX HBF 56 T6 (A5:6) F400 (35°)	Inlet	44	55	60	66	67	68	69	61	75
BOX HBF 56 T6 (A5:6) F400 (40°)	Inlet	50	63	73	78	78	72	70	61	82
BOX HBF 56 T6 (A5:6) F400 (45°)	Inlet	54	66	81	87	85	74	70	60	90
BOX HBF 63 T6 (A5:6) F400 (20°)	Inlet	63	70	75	76	77	74	73	66	82
BOX HBF 63 T6 (A5:6) F400 (25°)	Inlet	48	57	62	67	71	70	70	64	76
BOX HBF 63 T6 (A5:6) F400 (30°)	Inlet	51	59	69	76	74	73	73	66	80
BOX HBF 63 T6 (A5:6) F400 (35°)	Inlet	47	59	64	68	72	71	73	66	78

Sound power Lw dB (A)											
Model		63 Hz	125 Hz	250 Hz	500 Hz	1000 Hz	2000 Hz	4000 Hz	8000 Hz	Total	
BOX HBF 63 T6 (A5:6) F400 (40°)	Inlet	48	60	71	83	80	75	73	65	85	
BOX HBF 63 T6 (A5:6) F400 (45°)	Inlet	49	60	76	93	85	78	73	64	94	
BOX HBF 71 T6 (A5:6) F400 (20°)	Inlet	65	72	77	79	79	77	76	69	85	
BOX HBF 71 T6 (A5:6) F400 (25°)	Inlet	52	62	68	72	75	76	76	67	81	
BOX HBF 71 T6 (A5:6) F400 (30°)	Inlet	54	62	68	74	75	75	74	65	81	
BOX HBF 71 T6 (A5:6) F400 (35°)	Inlet	46	58	63	68	71	72	73	64	78	
BOX HBF 71 T6 (A5:6) F400 (40°)	Inlet	51	61	76	86	82	77	75	65	88	
BOX HBF 71 T6 (A5:6) F400 (45°)	Inlet	54	63	85	98	89	80	76	66	99	
BOX HBF 80 T6 (A5:6) F400 (20°)	Inlet	68	75	80	82	82	80	79	72	88	
BOX HBF 80 T6 (A5:6) F400 (25°)	Inlet	55	62	68	73	75	75	76	68	81	
BOX HBF 80 T6 (A5:6) F400 (30°)	Inlet	55	66	73	83	81	79	79	71	87	
BOX HBF 80 T6 (A5:6) F400 (35°)	Inlet	52	64	70	78	83	81	81	72	87	
BOX HBF 80 T6 (A5:6) F400 (40°)	Inlet	53	66	82	87	84	80	78	70	90	
BOX HBF 80 T6 (A5:6) F400 (45°)	Inlet	53	67	90	93	84	79	76	68	95	
BOX HBF 90 T6 (A3:4) F400 (20°)	Inlet	70	71	69	74	75	74	73	67	82	
BOX HBF 90 T6 (A3:4) F400 (22°)	Inlet	74	73	71	74	74	73	72	66	82	
BOX HBF 90 T6 (A3:4) F400 (24°)	Inlet	77	74	72	74	73	72	72	65	82	
BOX HBF 90 T6 (A3:4) F400 (26°)	Inlet	78	75	73	74	72	71	71	65	82	
BOX HBF 90 T6 (A3:4) F400 (28°)	Inlet	79	76	74	73	71	70	70	64	83	
BOX HBF 90 T6 (A3:4) F400 (30°)	Inlet	80	77	75	73	70	69	70	64	84	
BOX HBF 90 T6 (A3:4) F400 (32°)	Inlet	80	77	75	73	71	70	69	63	83	
BOX HBF 90 T6 (A3:4) F400 (34°)	Inlet	79	76	74	72	71	70	69	63	83	
BOX HBF 90 T6 (A3:4) F400 (36°)	Inlet	79	76	74	72	72	71	69	63	83	
BOX HBF 90 T6 (A3:4) F400 (38°)	Inlet	81	78	76	73	73	71	70	64	84	
BOX HBF 90 T6 (A3:4) F400 (40°)	Inlet	82	79	77	73	74	71	70	65	85	
BOX HBF 90 T6 (A3:4) F400 (42°)	Inlet	83	80	78	74	76	72	71	66	86	
BOX HBF 90 T6 (A3:8) F400 (20°)	Inlet	83	85	87	82	81	74	75	67	91	
BOX HBF 90 T6 (A3:8) F400 (22°)	Inlet	83	84	85	81	80	74	75	67	90	
BOX HBF 90 T6 (A3:8) F400 (24°)	Inlet	83	82	83	80	79	74	74	67	89	
BOX HBF 90 T6 (A3:8) F400 (26°)	Inlet	83	81	81	79	78	74	74	67	88	
BOX HBF 90 T6 (A3:8) F400 (28°)	Inlet	83	80	79	78	77	74	74	68	87	
BOX HBF 90 T6 (A3:8) F400 (30°)	Inlet	82	79	77	77	76	75	74	68	86	
BOX HBF 90 T6 (A3:8) F400 (32°)	Inlet	81	78	76	76	75	74	73	67	85	
BOX HBF 90 T6 (A3:8) F400 (34°)	Inlet	80	77	75	74	74	74	72	66	85	
BOX HBF 90 T6 (A3:8) F400 (36°)	Inlet	81	78	76	74	74	73	71	66	85	
BOX HBF 90 T6 (A3:8) F400 (38°)	Inlet	82	79	77	74	75	74	71	66	86	
BOX HBF 90 T6 (A3:8) F400 (40°)	Inlet	84	81	79	75	76	74	71	66	88	
BOX HBF 90 T6 (A3:8) F400 (42°)	Inlet	84	81	79	75	76	74	71	66	88	

Sound power Lw dB (A)										
Model		63 Hz	125 Hz	250 Hz	500 Hz	1000 Hz	2000 Hz	4000 Hz	8000 Hz	Total
BOX HBF 100 T6 (A3:4) F400 (20°)	Inlet	53	64	69	75	79	80	81	78	86
BOX HBF 100 T6 (A3:4) F400 (22°)	Inlet	54	64	69	75	79	80	81	77	86
BOX HBF 100 T6 (A3:4) F400 (24°)	Inlet	54	63	69	75	79	79	81	76	86
BOX HBF 100 T6 (A3:4) F400 (26°)	Inlet	54	63	68	74	78	79	80	75	85
BOX HBF 100 T6 (A3:4) F400 (28°)	Inlet	55	62	68	74	78	78	80	75	85
BOX HBF 100 T6 (A3:4) F400 (30°)	Inlet	55	62	68	74	77	78	80	74	84
BOX HBF 100 T6 (A3:4) F400 (32°)	Inlet	56	61	68	73	76	78	80	73	84
BOX HBF 100 T6 (A3:4) F400 (34°)	Inlet	56	60	68	73	76	77	79	73	83
BOX HBF 100 T6 (A3:4) F400 (36°)	Inlet	56	61	68	73	76	77	79	73	83
BOX HBF 100 T6 (A3:4) F400 (38°)	Inlet	56	62	69	74	77	78	79	73	84
BOX HBF 100 T6 (A3:4) F400 (40°)	Inlet	56	63	69	74	78	78	80	73	84
BOX HBF 100 T6 (A3:4) F400 (42°)	Inlet	57	64	70	76	79	79	80	75	86
BOX HBF 100 T6 (A3:8) F400 (20°)	Inlet	60	68	80	89	88	86	87	83	94
BOX HBF 100 T6 (A3:8) F400 (22°)	Inlet	60	68	79	87	86	85	86	82	93
BOX HBF 100 T6 (A3:8) F400 (24°)	Inlet	59	67	77	85	85	84	85	80	91
BOX HBF 100 T6 (A3:8) F400 (26°)	Inlet	59	67	76	83	84	84	84	79	90
BOX HBF 100 T6 (A3:8) F400 (28°)	Inlet	59	67	75	81	83	83	84	78	89
BOX HBF 100 T6 (A3:8) F400 (30°)	Inlet	59	66	74	79	82	83	83	77	89
BOX HBF 100 T6 (A3:8) F400 (32°)	Inlet	59	66	72	77	81	82	82	76	87
BOX HBF 100 T6 (A3:8) F400 (34°)	Inlet	58	65	70	75	79	81	82	75	86
BOX HBF 100 T6 (A3:8) F400 (36°)	Inlet	58	65	70	75	79	81	81	75	86
BOX HBF 100 T6 (A3:8) F400 (38°)	Inlet	58	65	70	76	79	81	82	76	87

Sound power Lw dB (A)										
Model		63 Hz	125 Hz	250 Hz	500 Hz	1000 Hz	2000 Hz	4000 Hz	8000 Hz	Total
BOX HBF 100 T6 (A3:8) F400 (40°)	Inlet	59	66	71	76	80	82	82	76	87
BOX HBF 100 T6 (A3:8) F400 (42°)	Inlet	59	66	71	77	80	82	82	76	87
BOX HBF 112 T6 (A3:4) F400 (20°)	Inlet	53	65	70	77	81	82	84	79	88
BOX HBF 112 T6 (A3:4) F400 (22°)	Inlet	55	66	71	78	82	82	84	79	89
BOX HBF 112 T6 (A3:4) F400 (24°)	Inlet	56	66	71	77	81	82	83	78	88
BOX HBF 112 T6 (A3:4) F400 (26°)	Inlet	57	66	71	77	80	81	83	77	87
BOX HBF 112 T6 (A3:4) F400 (28°)	Inlet	58	66	71	76	80	81	82	76	87
BOX HBF 112 T6 (A3:4) F400 (30°)	Inlet	58	65	70	76	79	80	82	75	86
BOX HBF 112 T6 (A3:4) F400 (32°)	Inlet	58	64	70	75	78	80	81	75	86
BOX HBF 112 T6 (A3:4) F400 (34°)	Inlet	58	63	70	75	78	79	81	74	85
BOX HBF 112 T6 (A3:4) F400 (36°)	Inlet	58	64	70	75	78	79	81	74	85
BOX HBF 112 T6 (A3:4) F400 (38°)	Inlet	59	65	71	75	78	80	81	74	86
BOX HBF 112 T6 (A3:4) F400 (40°)	Inlet	60	66	72	76	79	81	81	75	86
BOX HBF 112 T6 (A3:4) F400 (42°)	Inlet	60	67	72	77	80	81	82	75	87
BOX HBF 112 T6 (A3:8) F400 (20°)	Inlet	61	69	79	88	88	90	90	85	96
BOX HBF 112 T6 (A3:8) F400 (22°)	Inlet	61	69	78	86	87	89	89	84	95
BOX HBF 112 T6 (A3:8) F400 (24°)	Inlet	61	68	77	85	87	88	88	83	93
BOX HBF 112 T6 (A3:8) F400 (26°)	Inlet	61	68	76	83	86	87	87	82	93
BOX HBF 112 T6 (A3:8) F400 (28°)	Inlet	61	68	76	82	86	87	87	81	92
BOX HBF 112 T6 (A3:8) F400 (30°)	Inlet	62	68	75	80	85	86	86	81	91
BOX HBF 112 T6 (A3:8) F400 (32°)	Inlet	61	68	74	79	83	85	85	79	90
BOX HBF 112 T6 (A3:8) F400 (34°)	Inlet	61	68	73	78	81	83	84	77	89



Sound power Lw dB (A)										
Model		63 Hz	125 Hz	250 Hz	500 Hz	1000 Hz	2000 Hz	4000 Hz	8000 Hz	Total
BOX HBF 112 T6 (A3:8) F400 (36°)	Inlet	60	67	72	77	81	83	83	76	88
BOX HBF 112 T6 (A3:8) F400 (38°)	Inlet	61	68	73	78	81	83	83	77	88
BOX HBF 112 T6 (A3:8) F400 (40°)	Inlet	61	68	73	78	82	84	83	77	89
BOX HBF 112 T6 (A3:8) F400 (42°)	Inlet	61	68	73	78	82	83	83	76	88
BOX HBF 125 T6 (A3:4) F400 (20°)	Inlet	60	73	78	86	89	89	91	88	96
BOX HBF 125 T6 (A3:4) F400 (22°)	Inlet	62	74	79	86	89	90	92	88	96
BOX HBF 125 T6 (A3:4) F400 (24°)	Inlet	63	72	77	84	87	88	90	85	95
BOX HBF 125 T6 (A3:4) F400 (26°)	Inlet	63	71	76	82	86	87	88	83	93
BOX HBF 125 T6 (A3:4) F400 (28°)	Inlet	63	70	75	80	84	85	86	81	91
BOX HBF 125 T6 (A3:4) F400 (30°)	Inlet	62	69	74	78	82	84	85	78	89
BOX HBF 125 T6 (A3:4) F400 (32°)	Inlet	61	68	73	78	81	83	84	77	89
BOX HBF 125 T6 (A3:4) F400 (34°)	Inlet	61	68	73	78	81	82	83	76	88
BOX HBF 125 T6 (A3:4) F400 (36°)	Inlet	61	68	73	78	80	82	83	76	88
BOX HBF 125 T6 (A3:4) F400 (38°)	Inlet	62	69	74	78	81	83	83	76	88
BOX HBF 125 T6 (A3:4) F400 (40°)	Inlet	62	69	74	79	81	83	84	77	89
BOX HBF 125 T6 (A3:4) F400 (42°)	Inlet	63	70	75	79	82	84	84	78	89
BOX HBF 125 T6 (A3:8) F400 (20°)	Inlet	66	74	81	90	95	98	98	92	103
BOX HBF 125 T6 (A3:8) F400 (22°)	Inlet	66	74	81	89	94	97	96	91	102
BOX HBF 125 T6 (A3:8) F400 (24°)	Inlet	66	73	80	87	93	95	95	89	100
BOX HBF 125 T6 (A3:8) F400 (26°)	Inlet	66	72	79	86	91	94	93	87	99
BOX HBF 125 T6 (A3:8) F400 (28°)	Inlet	65	71	78	84	90	92	92	86	97
BOX HBF 125 T6 (A3:8) F400 (30°)	Inlet	65	71	77	83	88	90	91	84	95

Sound power Lw dB (A)										
Model		63 Hz	125 Hz	250 Hz	500 Hz	1000 Hz	2000 Hz	4000 Hz	8000 Hz	Total
BOX HBF 125 T6 (A3:8) F400 (32°)	Inlet	65	71	77	82	87	89	89	82	94
BOX HBF 125 T6 (A3:8) F400 (34°)	Inlet	65	71	77	81	85	87	87	80	92
BOX HBF 125 T6 (A3:8) F400 (36°)	Inlet	64	71	76	81	84	86	86	79	91
BOX HBF 125 T6 (A3:8) F400 (38°)	Inlet	64	71	76	81	84	86	85	78	91
BOX HBF 125 T6 (A3:8) F400 (40°)	Inlet	64	71	76	80	84	86	84	78	90
BOX HBF 125 T6 (A3:8) F400 (42°)	Inlet	64	71	76	81	84	85	84	78	90

## Sound / 4/8 poles

Sound power Lw dB (A)										
Model		63 Hz	125 Hz	250 Hz	500 Hz	1000 Hz	2000 Hz	4000 Hz	8000 Hz	Total
BOX HBF 45 T4/T8 (A5:6) F400 (720 RPM - 20°)	Inlet	28	33	40	47	49	51	49	41	56
BOX HBF 45 T4/T8 (A5:6) F400 (720 RPM - 25°)	Inlet	29	35	42	47	50	50	50	41	56
BOX HBF 45 T4/T8 (A5:6) F400 (720 RPM - 27°)	Inlet	30	37	44	47	50	49	51	41	56
BOX HBF 45 T4/T8 (A5:6) F400 (720 RPM - 30°)	Inlet	30	38	45	47	50	49	51	41	56
BOX HBF 45 T4/T8 (A5:6) F400 (720 RPM - 33°)	Inlet	28	38	45	46	49	48	50	41	55
BOX HBF 45 T4/T8 (A5:6) F400 (720 RPM - 35°)	Inlet	26	37	46	46	47	46	49	40	54
BOX HBF 45 T4/T8 (A5:6) F400 (720 RPM - 37°)	Inlet	27	38	46	46	49	48	50	41	55
BOX HBF 45 T4/T8 (A5:6) F400 (720 RPM - 40°)	Inlet	28	38	45	47	50	49	51	41	56
BOX HBF 45 T4/T8 (A5:6) F400 (720 RPM - 43°)	Inlet	29	38	45	47	51	50	51	41	57
BOX HBF 45 T4/T8 (A5:6) F400 (720 RPM - 45°)	Inlet	30	37	43	47	52	52	52	41	58
BOX HBF 45 T4/T8 (A5:6) F400 (1420 RPM - 20°)	Inlet	45	50	57	64	66	67	66	57	72
BOX HBF 45 T4/T8 (A5:6) F400 (1420 RPM - 25°)	Inlet	46	52	59	64	66	67	67	58	72
BOX HBF 45 T4/T8 (A5:6) F400 (1420 RPM - 27°)	Inlet	46	54	61	64	66	66	68	58	73

Sound power Lw dB (A)										
Model		63 Hz	125 Hz	250 Hz	500 Hz	1000 Hz	2000 Hz	4000 Hz	8000 Hz	Total
BOX HBF 45 T4/T8 (A5:6) F400 (1420 RPM - 30°)	Inlet	46	55	62	64	67	66	68	58	73
BOX HBF 45 T4/T8 (A5:6) F400 (1420 RPM - 33°)	Inlet	45	54	62	63	65	64	67	57	72
BOX HBF 45 T4/T8 (A5:6) F400 (1420 RPM - 35°)	Inlet	43	54	62	62	64	63	66	57	71
BOX HBF 45 T4/T8 (A5:6) F400 (1420 RPM - 37°)	Inlet	44	54	62	63	65	64	67	57	72
BOX HBF 45 T4/T8 (A5:6) F400 (1420 RPM - 40°)	Inlet	45	55	62	64	67	66	68	58	73
BOX HBF 45 T4/T8 (A5:6) F400 (1420 RPM - 43°)	Inlet	45	54	61	64	67	67	68	58	73
BOX HBF 45 T4/T8 (A5:6) F400 (1420 RPM - 45°)	Inlet	47	54	60	64	69	69	69	58	74
BOX HBF 50 T4/T8 (A5:6) F400 (720 RPM - 20°)	Inlet	31	37	46	52	58	56	55	46	62
BOX HBF 50 T4/T8 (A5:6) F400 (720 RPM - 25°)	Inlet	28	36	44	50	54	53	53	44	59
BOX HBF 50 T4/T8 (A5:6) F400 (720 RPM - 27°)	Inlet	26	34	41	47	50	49	51	42	56
BOX HBF 50 T4/T8 (A5:6) F400 (720 RPM - 30°)	Inlet	25	33	40	46	48	48	50	41	55
BOX HBF 50 T4/T8 (A5:6) F400 (720 RPM - 33°)	Inlet	26	35	42	47	48	48	51	43	56
BOX HBF 50 T4/T8 (A5:6) F400 (720 RPM - 35°)	Inlet	28	37	43	48	48	49	52	44	56
BOX HBF 50 T4/T8 (A5:6) F400 (720 RPM - 37°)	Inlet	29	38	45	50	50	51	54	47	58
BOX HBF 50 T4/T8 (A5:6) F400 (720 RPM - 40°)	Inlet	31	39	48	51	52	53	56	49	60
BOX HBF 50 T4/T8 (A5:6) F400 (720 RPM - 43°)	Inlet	31	39	48	51	52	53	56	49	60
BOX HBF 50 T4/T8 (A5:6) F400 (720 RPM - 45°)	Inlet	30	39	48	50	53	54	56	48	61
BOX HBF 50 T4/T8 (A5:6) F400 (1420 RPM - 20°)	Inlet	47	54	62	68	74	72	72	63	78
BOX HBF 50 T4/T8 (A5:6) F400 (1420 RPM - 25°)	Inlet	45	52	60	66	70	69	70	61	76
BOX HBF 50 T4/T8 (A5:6) F400 (1420 RPM - 27°)	Inlet	42	51	58	64	67	66	68	58	73
BOX HBF 50 T4/T8 (A5:6) F400 (1420 RPM - 30°)	Inlet	41	50	57	63	65	65	67	57	72
BOX HBF 50 T4/T8 (A5:6) F400 (1420 RPM - 33°)	Inlet	43	52	58	64	65	65	68	59	72

Sound power Lw dB (A)										
Model		63 Hz	125 Hz	250 Hz	500 Hz	1000 Hz	2000 Hz	4000 Hz	8000 Hz	Total
BOX HBF 50 T4/T8 (A5:6) F400 (1420 RPM - 35°)	Inlet	45	54	60	65	65	66	69	61	73
BOX HBF 50 T4/T8 (A5:6) F400 (1420 RPM - 37°)	Inlet	46	55	62	66	67	67	71	63	75
BOX HBF 50 T4/T8 (A5:6) F400 (1420 RPM - 40°)	Inlet	48	56	64	68	69	69	73	66	77
BOX HBF 50 T4/T8 (A5:6) F400 (1420 RPM - 43°)	Inlet	47	56	64	68	69	70	73	65	77
BOX HBF 50 T4/T8 (A5:6) F400 (1420 RPM - 45°)	Inlet	47	55	64	67	70	71	73	65	77
BOX HBF 56 T4/T8 (A5:6) F400 (750 RPM - 20°)	Inlet	47	54	59	60	61	59	57	49	67
BOX HBF 56 T4/T8 (A5:6) F400 (750 RPM - 25°)	Inlet	34	43	48	54	56	56	57	48	63
BOX HBF 56 T4/T8 (A5:6) F400 (750 RPM - 30°)	Inlet	43	53	60	62	62	60	58	50	68
BOX HBF 56 T4/T8 (A5:6) F400 (750 RPM - 35°)	Inlet	31	43	48	54	55	56	57	49	62
BOX HBF 56 T4/T8 (A5:6) F400 (750 RPM - 40°)	Inlet	37	50	60	66	65	59	57	48	70
BOX HBF 56 T4/T8 (A5:6) F400 (750 RPM - 45°)	Inlet	42	54	69	75	72	61	57	48	78
BOX HBF 56 T4/T8 (A5:6) F400 (1500 RPM - 20°)	Inlet	63	70	75	76	77	75	73	65	83
BOX HBF 56 T4/T8 (A5:6) F400 (1500 RPM - 25°)	Inlet	50	59	64	70	72	72	73	64	79
BOX HBF 56 T4/T8 (A5:6) F400 (1500 RPM - 30°)	Inlet	59	69	76	78	78	76	74	66	84
BOX HBF 56 T4/T8 (A5:6) F400 (1500 RPM - 35°)	Inlet	47	59	64	70	71	72	73	65	78
BOX HBF 56 T4/T8 (A5:6) F400 (1500 RPM - 40°)	Inlet	53	66	76	82	81	75	73	64	86
BOX HBF 56 T4/T8 (A5:6) F400 (1500 RPM - 45°)	Inlet	57	70	85	91	88	77	73	64	93
BOX HBF 63 T4/T8 (A5:6) F400 (750 RPM - 20°)	Inlet	50	57	62	63	64	61	60	53	70
BOX HBF 63 T4/T8 (A5:6) F400 (750 RPM - 25°)	Inlet	36	45	50	55	59	58	58	51	64
BOX HBF 63 T4/T8 (A5:6) F400 (750 RPM - 30°)	Inlet	38	46	56	63	61	60	60	53	68
BOX HBF 63 T4/T8 (A5:6) F400 (750 RPM - 35°)	Inlet	34	46	51	55	59	58	60	53	65
BOX HBF 63 T4/T8 (A5:6) F400 (750 RPM - 40°)	Inlet	35	47	59	70	67	62	60	52	73

Sound power Lw dB (A)										
Model		63 Hz	125 Hz	250 Hz	500 Hz	1000 Hz	2000 Hz	4000 Hz	8000 Hz	Total
BOX HBF 63 T4/T8 (A5:6) F400 (750 RPM - 45°)	Inlet	36	47	64	81	73	65	60	52	82
BOX HBF 63 T4/T8 (A5:6) F400 (1500 RPM - 20°)	Inlet	66	73	78	79	80	77	76	69	86
BOX HBF 63 T4/T8 (A5:6) F400 (1500 RPM - 25°)	Inlet	51	60	65	70	74	73	73	67	80
BOX HBF 63 T4/T8 (A5:6) F400 (1500 RPM - 30°)	Inlet	54	62	72	79	77	76	76	69	84
BOX HBF 63 T4/T8 (A5:6) F400 (1500 RPM - 35°)	Inlet	50	62	67	71	75	74	76	69	81
BOX HBF 63 T4/T8 (A5:6) F400 (1500 RPM - 40°)	Inlet	51	63	74	86	83	78	76	68	89
BOX HBF 63 T4/T8 (A5:6) F400 (1500 RPM - 45°)	Inlet	52	63	79	97	89	81	76	68	97
BOX HBF 71 T4/T8 (A5:6) F400 (750 RPM - 20°)	Inlet	53	60	65	67	67	65	64	57	73
BOX HBF 71 T4/T8 (A5:6) F400 (750 RPM - 25°)	Inlet	40	49	55	59	62	63	63	54	69
BOX HBF 71 T4/T8 (A5:6) F400 (750 RPM - 30°)	Inlet	41	50	56	62	63	63	62	53	69
BOX HBF 71 T4/T8 (A5:6) F400 (750 RPM - 35°)	Inlet	34	46	51	56	59	60	61	52	66
BOX HBF 71 T4/T8 (A5:6) F400 (750 RPM - 40°)	Inlet	38	49	64	73	69	65	63	53	76
BOX HBF 71 T4/T8 (A5:6) F400 (750 RPM - 45°)	Inlet	42	51	73	86	77	68	64	53	87
BOX HBF 71 T4/T8 (A5:6) F400 (1500 RPM - 20°)	Inlet	68	75	80	82	82	80	79	72	89
BOX HBF 71 T4/T8 (A5:6) F400 (1500 RPM - 25°)	Inlet	55	65	71	75	78	79	79	70	85
BOX HBF 71 T4/T8 (A5:6) F400 (1500 RPM - 30°)	Inlet	57	65	72	78	79	78	78	69	84
BOX HBF 71 T4/T8 (A5:6) F400 (1500 RPM - 35°)	Inlet	50	62	67	72	75	76	77	68	81
BOX HBF 71 T4/T8 (A5:6) F400 (1500 RPM - 40°)	Inlet	54	65	80	89	85	80	78	69	92
BOX HBF 71 T4/T8 (A5:6) F400 (1500 RPM - 45°)	Inlet	58	67	89	102	93	84	80	69	102
BOX HBF 80 T4/T8 (A5:6) F400 (750 RPM - 20°)	Inlet	55	62	67	69	69	67	66	59	76
BOX HBF 80 T4/T8 (A5:6) F400 (750 RPM - 25°)	Inlet	42	49	55	60	62	62	63	55	69
BOX HBF 80 T4/T8 (A5:6) F400 (750 RPM - 30°)	Inlet	42	54	61	70	68	66	66	58	75

Sound power Lw dB (A)										
Model		63 Hz	125 Hz	250 Hz	500 Hz	1000 Hz	2000 Hz	4000 Hz	8000 Hz	Total
BOX HBF 80 T4/T8 (A5:6) F400 (750 RPM - 35°)	Inlet	39	51	57	65	70	68	68	59	75
BOX HBF 80 T4/T8 (A5:6) F400 (750 RPM - 40°)	Inlet	40	53	69	74	71	67	65	57	78
BOX HBF 80 T4/T8 (A5:6) F400 (750 RPM - 45°)	Inlet	41	55	78	81	72	67	63	56	83
BOX HBF 80 T4/T8 (A5:6) F400 (1500 RPM - 20°)	Inlet	71	78	83	85	85	83	82	75	91
BOX HBF 80 T4/T8 (A5:6) F400 (1500 RPM - 25°)	Inlet	58	65	71	76	78	78	79	71	85
BOX HBF 80 T4/T8 (A5:6) F400 (1500 RPM - 30°)	Inlet	58	69	76	86	84	82	82	74	90
BOX HBF 80 T4/T8 (A5:6) F400 (1500 RPM - 35°)	Inlet	55	67	73	81	86	84	84	75	91
BOX HBF 80 T4/T8 (A5:6) F400 (1500 RPM - 40°)	Inlet	56	69	85	90	87	83	81	73	94
BOX HBF 80 T4/T8 (A5:6) F400 (1500 RPM - 45°)	Inlet	57	71	94	97	88	83	79	72	99
BOX HBF 90 T4/T8 (A3:4) F400 (750 RPM - 20°)	Inlet	64	65	63	68	69	68	66	60	75
BOX HBF 90 T4/T8 (A3:4) F400 (750 RPM - 22°)	Inlet	68	66	64	67	68	67	66	60	75
BOX HBF 90 T4/T8 (A3:4) F400 (750 RPM - 24°)	Inlet	70	67	65	67	67	66	65	59	76
BOX HBF 90 T4/T8 (A3:4) F400 (750 RPM - 26°)	Inlet	71	68	66	67	66	65	64	58	76
BOX HBF 90 T4/T8 (A3:4) F400 (750 RPM - 28°)	Inlet	72	69	67	67	65	64	64	58	77
BOX HBF 90 T4/T8 (A3:4) F400 (750 RPM - 30°)	Inlet	74	71	69	67	64	63	63	57	77
BOX HBF 90 T4/T8 (A3:4) F400 (750 RPM - 32°)	Inlet	73	70	68	66	64	63	63	57	77
BOX HBF 90 T4/T8 (A3:4) F400 (750 RPM - 34°)	Inlet	73	70	68	66	64	64	62	56	76
BOX HBF 90 T4/T8 (A3:4) F400 (750 RPM - 36°)	Inlet	73	70	68	66	65	64	63	56	77
BOX HBF 90 T4/T8 (A3:4) F400 (750 RPM - 38°)	Inlet	74	71	69	66	66	65	63	58	78
BOX HBF 90 T4/T8 (A3:4) F400 (750 RPM - 40°)	Inlet	75	72	70	67	68	65	64	59	79
BOX HBF 90 T4/T8 (A3:4) F400 (750 RPM - 42°)	Inlet	76	73	71	68	69	66	65	60	80
BOX HBF 90 T4/T8 (A3:4) F400 (1500 RPM - 20°)	Inlet	80	81	79	84	85	84	82	76	91

Sound power Lw dB (A)										
Model		63 Hz	125 Hz	250 Hz	500 Hz	1000 Hz	2000 Hz	4000 Hz	8000 Hz	Total
BOX HBF 90 T4/T8 (A3:4) F400 (1500 RPM - 22°)	Inlet	84	82	80	83	84	83	82	75	91
BOX HBF 90 T4/T8 (A3:4) F400 (1500 RPM - 24°)	Inlet	86	83	81	83	83	82	81	75	92
BOX HBF 90 T4/T8 (A3:4) F400 (1500 RPM - 26°)	Inlet	87	84	82	83	82	81	80	74	92
BOX HBF 90 T4/T8 (A3:4) F400 (1500 RPM - 28°)	Inlet	88	85	83	83	81	80	80	74	92
BOX HBF 90 T4/T8 (A3:4) F400 (1500 RPM - 30°)	Inlet	89	86	84	83	80	79	79	73	93
BOX HBF 90 T4/T8 (A3:4) F400 (1500 RPM - 32°)	Inlet	89	86	84	82	80	79	79	73	93
BOX HBF 90 T4/T8 (A3:4) F400 (1500 RPM - 34°)	Inlet	88	85	83	81	80	80	78	72	92
BOX HBF 90 T4/T8 (A3:4) F400 (1500 RPM - 36°)	Inlet	89	86	84	81	81	80	78	72	93
BOX HBF 90 T4/T8 (A3:4) F400 (1500 RPM - 38°)	Inlet	90	87	85	82	82	80	79	74	94
BOX HBF 90 T4/T8 (A3:4) F400 (1500 RPM - 40°)	Inlet	91	88	86	83	84	81	80	75	95
BOX HBF 90 T4/T8 (A3:4) F400 (1500 RPM - 42°)	Inlet	92	89	87	84	85	82	81	76	96
BOX HBF 90 T4/T8 (A3:8) F400 (750 RPM - 20°)	Inlet	76	78	80	75	74	67	68	60	85
BOX HBF 90 T4/T8 (A3:8) F400 (750 RPM - 22°)	Inlet	76	77	78	74	73	68	68	60	84
BOX HBF 90 T4/T8 (A3:8) F400 (750 RPM - 24°)	Inlet	77	76	76	73	72	68	68	61	83
BOX HBF 90 T4/T8 (A3:8) F400 (750 RPM - 26°)	Inlet	77	75	74	72	71	68	68	61	82
BOX HBF 90 T4/T8 (A3:8) F400 (750 RPM - 28°)	Inlet	77	73	72	71	70	68	67	61	81
BOX HBF 90 T4/T8 (A3:8) F400 (750 RPM - 30°)	Inlet	75	72	70	70	69	68	67	61	80
BOX HBF 90 T4/T8 (A3:8) F400 (750 RPM - 32°)	Inlet	75	72	70	69	68	68	66	60	79
BOX HBF 90 T4/T8 (A3:8) F400 (750 RPM - 34°)	Inlet	74	71	69	68	68	67	65	59	78
BOX HBF 90 T4/T8 (A3:8) F400 (750 RPM - 36°)	Inlet	74	71	69	67	68	67	65	59	78
BOX HBF 90 T4/T8 (A3:8) F400 (750 RPM - 38°)	Inlet	76	73	71	68	68	67	65	59	80
BOX HBF 90 T4/T8 (A3:8) F400 (750 RPM - 40°)	Inlet	78	75	73	68	69	67	64	60	81

Sound power Lw dB (A)										
Model		63 Hz	125 Hz	250 Hz	500 Hz	1000 Hz	2000 Hz	4000 Hz	8000 Hz	Total
BOX HBF 90 T4/T8 (A3:8) F400 (750 RPM - 42°)	Inlet	78	75	73	69	70	68	65	60	82
BOX HBF 90 T4/T8 (A3:8) F400 (1500 RPM - 20°)	Inlet	92	94	96	91	90	83	84	76	101
BOX HBF 90 T4/T8 (A3:8) F400 (1500 RPM - 22°)	Inlet	92	93	94	90	89	83	84	76	100
BOX HBF 90 T4/T8 (A3:8) F400 (1500 RPM - 24°)	Inlet	92	92	92	89	88	84	84	76	99
BOX HBF 90 T4/T8 (A3:8) F400 (1500 RPM - 26°)	Inlet	93	91	90	88	87	84	84	77	98
BOX HBF 90 T4/T8 (A3:8) F400 (1500 RPM - 28°)	Inlet	93	89	88	87	86	84	83	77	97
BOX HBF 90 T4/T8 (A3:8) F400 (1500 RPM - 30°)	Inlet	91	88	86	86	85	84	83	77	96
BOX HBF 90 T4/T8 (A3:8) F400 (1500 RPM - 32°)	Inlet	90	87	85	85	84	83	82	76	95
BOX HBF 90 T4/T8 (A3:8) F400 (1500 RPM - 34°)	Inlet	90	87	85	84	84	83	81	75	94
BOX HBF 90 T4/T8 (A3:8) F400 (1500 RPM - 36°)	Inlet	90	87	85	83	84	83	81	75	94
BOX HBF 90 T4/T8 (A3:8) F400 (1500 RPM - 38°)	Inlet	92	89	87	84	84	83	80	75	96
BOX HBF 90 T4/T8 (A3:8) F400 (1500 RPM - 40°)	Inlet	94	91	89	84	85	83	80	76	97
BOX HBF 90 T4/T8 (A3:8) F400 (1500 RPM - 42°)	Inlet	94	91	89	85	85	84	81	76	98
BOX HBF 100 T4/T8 (A3:4) F400 (750 RPM - 20°)	Inlet	47	57	63	69	73	73	74	71	79
BOX HBF 100 T4/T8 (A3:4) F400 (750 RPM - 22°)	Inlet	47	57	63	69	73	73	74	71	79
BOX HBF 100 T4/T8 (A3:4) F400 (750 RPM - 24°)	Inlet	48	57	63	69	72	73	74	70	79
BOX HBF 100 T4/T8 (A3:4) F400 (750 RPM - 26°)	Inlet	48	56	62	68	71	72	74	69	79
BOX HBF 100 T4/T8 (A3:4) F400 (750 RPM - 28°)	Inlet	48	56	62	68	71	72	74	68	78
BOX HBF 100 T4/T8 (A3:4) F400 (750 RPM - 30°)	Inlet	49	56	62	67	71	72	74	67	78
BOX HBF 100 T4/T8 (A3:4) F400 (750 RPM - 32°)	Inlet	49	55	62	67	70	71	73	67	77
BOX HBF 100 T4/T8 (A3:4) F400 (750 RPM - 34°)	Inlet	50	54	62	66	69	71	73	66	77
BOX HBF 100 T4/T8 (A3:4) F400 (750 RPM - 36°)	Inlet	50	54	62	67	69	71	72	66	77



Sound power Lw dB (A)										
Model		63 Hz	125 Hz	250 Hz	500 Hz	1000 Hz	2000 Hz	4000 Hz	8000 Hz	Total
BOX HBF 100 T4/T8 (A3:4) F400 (750 RPM - 38°)	Inlet	49	55	62	67	70	71	73	66	77
BOX HBF 100 T4/T8 (A3:4) F400 (750 RPM - 40°)	Inlet	49	56	63	68	72	72	73	67	78
BOX HBF 100 T4/T8 (A3:4) F400 (750 RPM - 42°)	Inlet	50	58	64	69	73	73	74	68	79
BOX HBF 100 T4/T8 (A3:4) F400 (1500 RPM - 20°)	Inlet	63	73	78	85	88	89	90	87	95
BOX HBF 100 T4/T8 (A3:4) F400 (1500 RPM - 22°)	Inlet	63	73	79	85	88	89	90	87	95
BOX HBF 100 T4/T8 (A3:4) F400 (1500 RPM - 24°)	Inlet	64	73	78	84	88	89	90	86	95
BOX HBF 100 T4/T8 (A3:4) F400 (1500 RPM - 26°)	Inlet	64	72	78	84	87	88	90	85	94
BOX HBF 100 T4/T8 (A3:4) F400 (1500 RPM - 28°)	Inlet	64	72	78	83	87	88	90	84	94
BOX HBF 100 T4/T8 (A3:4) F400 (1500 RPM - 30°)	Inlet	65	71	78	83	87	88	90	83	94
BOX HBF 100 T4/T8 (A3:4) F400 (1500 RPM - 32°)	Inlet	65	71	78	83	86	87	89	83	93
BOX HBF 100 T4/T8 (A3:4) F400 (1500 RPM - 34°)	Inlet	66	70	78	82	85	87	88	82	93
BOX HBF 100 T4/T8 (A3:4) F400 (1500 RPM - 36°)	Inlet	66	70	78	83	85	87	88	82	93
BOX HBF 100 T4/T8 (A3:4) F400 (1500 RPM - 38°)	Inlet	65	71	78	83	86	87	89	82	93
BOX HBF 100 T4/T8 (A3:4) F400 (1500 RPM - 40°)	Inlet	65	72	78	84	87	88	89	83	94
BOX HBF 100 T4/T8 (A3:4) F400 (1500 RPM - 42°)	Inlet	66	74	80	85	89	89	90	84	95
BOX HBF 100 T4/T8 (A3:8) F400 (750 RPM - 20°)	Inlet	53	62	73	83	81	80	81	76	88
BOX HBF 100 T4/T8 (A3:8) F400 (750 RPM - 22°)	Inlet	53	61	72	81	80	79	80	75	87
BOX HBF 100 T4/T8 (A3:8) F400 (750 RPM - 24°)	Inlet	53	61	70	78	79	78	79	74	85
BOX HBF 100 T4/T8 (A3:8) F400 (750 RPM - 26°)	Inlet	53	60	69	76	77	77	78	73	84
BOX HBF 100 T4/T8 (A3:8) F400 (750 RPM - 28°)	Inlet	53	60	68	74	77	77	77	72	83
BOX HBF 100 T4/T8 (A3:8) F400 (750 RPM - 30°)	Inlet	53	60	67	72	76	76	77	71	82
BOX HBF 100 T4/T8 (A3:8) F400 (750 RPM - 32°)	Inlet	52	60	65	71	74	75	76	70	81

Sound power Lw dB (A)										
Model		63 Hz	125 Hz	250 Hz	500 Hz	1000 Hz	2000 Hz	4000 Hz	8000 Hz	Total
BOX HBF 100 T4/T8 (A3:8) F400 (750 RPM - 34°)	Inlet	52	59	64	69	73	74	75	69	80
BOX HBF 100 T4/T8 (A3:8) F400 (750 RPM - 36°)	Inlet	51	58	63	68	72	74	75	69	80
BOX HBF 100 T4/T8 (A3:8) F400 (750 RPM - 38°)	Inlet	52	59	64	69	73	75	75	69	80
BOX HBF 100 T4/T8 (A3:8) F400 (750 RPM - 40°)	Inlet	53	60	65	70	73	75	76	70	81
BOX HBF 100 T4/T8 (A3:8) F400 (750 RPM - 42°)	Inlet	53	60	65	70	74	75	76	70	81
BOX HBF 100 T4/T8 (A3:8) F400 (1500 RPM - 20°)	Inlet	69	78	89	99	97	96	97	92	104
BOX HBF 100 T4/T8 (A3:8) F400 (1500 RPM - 22°)	Inlet	69	77	88	97	96	95	96	91	103
BOX HBF 100 T4/T8 (A3:8) F400 (1500 RPM - 24°)	Inlet	69	76	86	94	94	94	95	90	101
BOX HBF 100 T4/T8 (A3:8) F400 (1500 RPM - 26°)	Inlet	69	76	85	92	93	93	94	89	100
BOX HBF 100 T4/T8 (A3:8) F400 (1500 RPM - 28°)	Inlet	69	76	84	90	93	92	93	88	99
BOX HBF 100 T4/T8 (A3:8) F400 (1500 RPM - 30°)	Inlet	69	76	83	88	92	92	93	87	98
BOX HBF 100 T4/T8 (A3:8) F400 (1500 RPM - 32°)	Inlet	68	76	81	87	90	91	92	86	97
BOX HBF 100 T4/T8 (A3:8) F400 (1500 RPM - 34°)	Inlet	68	75	80	85	89	90	91	85	96
BOX HBF 100 T4/T8 (A3:8) F400 (1500 RPM - 36°)	Inlet	67	74	79	84	88	90	91	84	96
BOX HBF 100 T4/T8 (A3:8) F400 (1500 RPM - 38°)	Inlet	68	75	80	85	89	91	91	85	96
BOX HBF 100 T4/T8 (A3:8) F400 (1500 RPM - 40°)	Inlet	68	76	81	86	89	91	92	86	97
BOX HBF 100 T4/T8 (A3:8) F400 (1500 RPM - 42°)	Inlet	69	76	81	86	90	91	92	86	97
BOX HBF 112 T4/T8 (A3:4) F400 (750 RPM - 20°)	Inlet	47	59	64	71	75	75	77	73	82
BOX HBF 112 T4/T8 (A3:4) F400 (750 RPM - 22°)	Inlet	49	60	65	71	75	76	78	73	83
BOX HBF 112 T4/T8 (A3:4) F400 (750 RPM - 24°)	Inlet	50	59	64	71	74	75	77	72	82
BOX HBF 112 T4/T8 (A3:4) F400 (750 RPM - 26°)	Inlet	51	59	64	70	74	75	76	71	81
BOX HBF 112 T4/T8 (A3:4) F400 (750 RPM - 28°)	Inlet	52	59	64	70	73	74	76	70	80

Sound power Lw dB (A)										
Model		63 Hz	125 Hz	250 Hz	500 Hz	1000 Hz	2000 Hz	4000 Hz	8000 Hz	Total
BOX HBF 112 T4/T8 (A3:4) F400 (750 RPM - 30°)	Inlet	52	59	64	69	73	74	75	69	80
BOX HBF 112 T4/T8 (A3:4) F400 (750 RPM - 32°)	Inlet	52	58	64	69	72	73	75	68	79
BOX HBF 112 T4/T8 (A3:4) F400 (750 RPM - 34°)	Inlet	51	57	63	68	71	73	74	67	79
BOX HBF 112 T4/T8 (A3:4) F400 (750 RPM - 36°)	Inlet	52	57	64	68	71	73	74	67	79
BOX HBF 112 T4/T8 (A3:4) F400 (750 RPM - 38°)	Inlet	52	58	64	69	72	73	75	68	79
BOX HBF 112 T4/T8 (A3:4) F400 (750 RPM - 40°)	Inlet	53	60	65	70	73	74	75	68	80
BOX HBF 112 T4/T8 (A3:4) F400 (750 RPM - 42°)	Inlet	54	60	66	70	73	75	75	69	80
BOX HBF 112 T4/T8 (A3:4) F400 (1500 RPM - 20°)	Inlet	63	75	80	87	91	91	93	89	98
BOX HBF 112 T4/T8 (A3:4) F400 (1500 RPM - 22°)	Inlet	65	76	81	87	91	92	93	89	99
BOX HBF 112 T4/T8 (A3:4) F400 (1500 RPM - 24°)	Inlet	66	75	80	87	90	91	93	88	98
BOX HBF 112 T4/T8 (A3:4) F400 (1500 RPM - 26°)	Inlet	67	75	80	86	90	91	92	87	97
BOX HBF 112 T4/T8 (A3:4) F400 (1500 RPM - 28°)	Inlet	68	75	80	86	89	90	92	86	96
BOX HBF 112 T4/T8 (A3:4) F400 (1500 RPM - 30°)	Inlet	68	75	80	85	89	90	91	85	96
BOX HBF 112 T4/T8 (A3:4) F400 (1500 RPM - 32°)	Inlet	67	74	79	85	88	89	91	84	95
BOX HBF 112 T4/T8 (A3:4) F400 (1500 RPM - 34°)	Inlet	67	73	79	84	87	89	90	83	95
BOX HBF 112 T4/T8 (A3:4) F400 (1500 RPM - 36°)	Inlet	68	73	80	84	87	89	90	83	95
BOX HBF 112 T4/T8 (A3:4) F400 (1500 RPM - 38°)	Inlet	68	74	80	85	88	89	90	84	95
BOX HBF 112 T4/T8 (A3:4) F400 (1500 RPM - 40°)	Inlet	69	76	81	86	88	90	91	84	96
BOX HBF 112 T4/T8 (A3:4) F400 (1500 RPM - 42°)	Inlet	69	76	81	86	89	91	91	85	96
BOX HBF 112 T4/T8 (A3:8) F400 (750 RPM - 20°)	Inlet	54	63	73	82	82	84	84	78	90
BOX HBF 112 T4/T8 (A3:8) F400 (750 RPM - 22°)	Inlet	54	62	72	80	81	83	83	77	88
BOX HBF 112 T4/T8 (A3:8) F400 (750 RPM - 24°)	Inlet	54	62	71	78	80	82	82	76	87

Sound power Lw dB (A)										
Model		63 Hz	125 Hz	250 Hz	500 Hz	1000 Hz	2000 Hz	4000 Hz	8000 Hz	Total
BOX HBF 112 T4/T8 (A3:8) F400 (750 RPM - 26°)	Inlet	55	62	70	77	80	81	81	75	87
BOX HBF 112 T4/T8 (A3:8) F400 (750 RPM - 28°)	Inlet	55	62	69	75	79	80	80	75	86
BOX HBF 112 T4/T8 (A3:8) F400 (750 RPM - 30°)	Inlet	55	62	69	74	78	80	80	74	85
BOX HBF 112 T4/T8 (A3:8) F400 (750 RPM - 32°)	Inlet	55	62	67	73	77	78	78	72	84
BOX HBF 112 T4/T8 (A3:8) F400 (750 RPM - 34°)	Inlet	54	61	66	71	75	77	77	70	82
BOX HBF 112 T4/T8 (A3:8) F400 (750 RPM - 36°)	Inlet	54	61	66	71	74	76	77	70	82
BOX HBF 112 T4/T8 (A3:8) F400 (750 RPM - 38°)	Inlet	54	61	66	71	75	77	77	70	82
BOX HBF 112 T4/T8 (A3:8) F400 (750 RPM - 40°)	Inlet	55	62	67	71	75	77	77	71	83
BOX HBF 112 T4/T8 (A3:8) F400 (750 RPM - 42°)	Inlet	55	62	67	72	75	77	76	70	82
BOX HBF 112 T4/T8 (A3:8) F400 (1500 RPM - 20°)	Inlet	70	79	89	98	98	100	100	94	106
BOX HBF 112 T4/T8 (A3:8) F400 (1500 RPM - 22°)	Inlet	70	78	88	96	97	99	99	93	104
BOX HBF 112 T4/T8 (A3:8) F400 (1500 RPM - 24°)	Inlet	70	78	87	94	96	98	98	92	103
BOX HBF 112 T4/T8 (A3:8) F400 (1500 RPM - 26°)	Inlet	71	78	86	93	95	97	97	91	103
BOX HBF 112 T4/T8 (A3:8) F400 (1500 RPM - 28°)	Inlet	71	78	85	91	95	96	96	91	102
BOX HBF 112 T4/T8 (A3:8) F400 (1500 RPM - 30°)	Inlet	71	77	84	90	94	96	96	90	101
BOX HBF 112 T4/T8 (A3:8) F400 (1500 RPM - 32°)	Inlet	71	78	83	88	93	94	94	88	100
BOX HBF 112 T4/T8 (A3:8) F400 (1500 RPM - 34°)	Inlet	70	77	82	87	91	93	93	86	98
BOX HBF 112 T4/T8 (A3:8) F400 (1500 RPM - 36°)	Inlet	70	77	82	87	90	92	92	86	98
BOX HBF 112 T4/T8 (A3:8) F400 (1500 RPM - 38°)	Inlet	70	77	82	87	91	93	92	86	98
BOX HBF 112 T4/T8 (A3:8) F400 (1500 RPM - 40°)	Inlet	71	78	83	87	91	93	92	87	99
BOX HBF 112 T4/T8 (A3:8) F400 (1500 RPM - 42°)	Inlet	70	77	82	88	91	93	92	86	98
BOX HBF 125 T4/T8 (A3:4) F400 (750 RPM - 20°)	Inlet	53	66	71	79	83	83	85	82	90

Sound power Lw dB (A)										
Model		63 Hz	125 Hz	250 Hz	500 Hz	1000 Hz	2000 Hz	4000 Hz	8000 Hz	Total
BOX HBF 125 T4/T8 (A3:4) F400 (750 RPM - 22°)	Inlet	56	67	72	79	83	84	86	82	90
BOX HBF 125 T4/T8 (A3:4) F400 (750 RPM - 24°)	Inlet	56	66	71	77	81	82	84	79	88
BOX HBF 125 T4/T8 (A3:4) F400 (750 RPM - 26°)	Inlet	57	65	70	75	79	80	82	77	87
BOX HBF 125 T4/T8 (A3:4) F400 (750 RPM - 28°)	Inlet	57	64	69	74	77	79	80	74	85
BOX HBF 125 T4/T8 (A3:4) F400 (750 RPM - 30°)	Inlet	55	62	67	72	76	77	78	72	83
BOX HBF 125 T4/T8 (A3:4) F400 (750 RPM - 32°)	Inlet	55	62	67	72	75	77	78	71	83
BOX HBF 125 T4/T8 (A3:4) F400 (750 RPM - 34°)	Inlet	55	62	67	71	74	76	77	69	82
BOX HBF 125 T4/T8 (A3:4) F400 (750 RPM - 36°)	Inlet	55	62	67	71	74	76	77	69	82
BOX HBF 125 T4/T8 (A3:4) F400 (750 RPM - 38°)	Inlet	55	62	67	72	74	76	77	70	82
BOX HBF 125 T4/T8 (A3:4) F400 (750 RPM - 40°)	Inlet	56	63	68	72	75	77	77	70	83
BOX HBF 125 T4/T8 (A3:4) F400 (750 RPM - 42°)	Inlet	56	63	68	73	76	78	77	71	83
BOX HBF 125 T4/T8 (A3:4) F400 (1500 RPM - 20°)	Inlet	69	82	87	95	99	99	101	98	106
BOX HBF 125 T4/T8 (A3:4) F400 (1500 RPM - 22°)	Inlet	72	83	88	95	99	100	102	98	106
BOX HBF 125 T4/T8 (A3:4) F400 (1500 RPM - 24°)	Inlet	72	82	87	93	97	98	100	95	104
BOX HBF 125 T4/T8 (A3:4) F400 (1500 RPM - 26°)	Inlet	73	81	86	91	95	96	98	93	103
BOX HBF 125 T4/T8 (A3:4) F400 (1500 RPM - 28°)	Inlet	72	79	84	90	93	95	96	90	101
BOX HBF 125 T4/T8 (A3:4) F400 (1500 RPM - 30°)	Inlet	71	78	83	88	92	93	94	88	99
BOX HBF 125 T4/T8 (A3:4) F400 (1500 RPM - 32°)	Inlet	71	78	83	87	91	93	93	87	99
BOX HBF 125 T4/T8 (A3:4) F400 (1500 RPM - 34°)	Inlet	70	77	82	87	90	92	93	85	98
BOX HBF 125 T4/T8 (A3:4) F400 (1500 RPM - 36°)	Inlet	71	78	83	87	90	92	93	85	98
BOX HBF 125 T4/T8 (A3:4) F400 (1500 RPM - 38°)	Inlet	71	78	83	88	90	92	93	86	98
BOX HBF 125 T4/T8 (A3:4) F400 (1500 RPM - 40°)	Inlet	72	79	84	88	90	93	93	86	99

Sound power Lw dB (A)										
Model		63 Hz	125 Hz	250 Hz	500 Hz	1000 Hz	2000 Hz	4000 Hz	8000 Hz	Total
BOX HBF 125 T4/T8 (A3:4) F400 (1500 RPM - 42°)	Inlet	72	79	84	89	91	93	93	87	99
BOX HBF 125 T4/T8 (A3:8) F400 (750 RPM - 20°)	Inlet	59	68	75	84	89	92	91	86	96
BOX HBF 125 T4/T8 (A3:8) F400 (750 RPM - 22°)	Inlet	60	67	74	83	88	91	90	85	95
BOX HBF 125 T4/T8 (A3:8) F400 (750 RPM - 24°)	Inlet	59	67	73	81	87	89	89	83	94
BOX HBF 125 T4/T8 (A3:8) F400 (750 RPM - 26°)	Inlet	59	66	72	79	85	87	87	81	92
BOX HBF 125 T4/T8 (A3:8) F400 (750 RPM - 28°)	Inlet	59	65	72	78	83	86	86	79	91
BOX HBF 125 T4/T8 (A3:8) F400 (750 RPM - 30°)	Inlet	59	64	71	77	82	84	85	78	89
BOX HBF 125 T4/T8 (A3:8) F400 (750 RPM - 32°)	Inlet	58	64	70	76	80	83	83	76	88
BOX HBF 125 T4/T8 (A3:8) F400 (750 RPM - 34°)	Inlet	58	65	70	75	78	81	81	73	86
BOX HBF 125 T4/T8 (A3:8) F400 (750 RPM - 36°)	Inlet	58	65	70	74	78	80	79	72	85
BOX HBF 125 T4/T8 (A3:8) F400 (750 RPM - 38°)	Inlet	57	64	69	74	77	79	79	72	85
BOX HBF 125 T4/T8 (A3:8) F400 (750 RPM - 40°)	Inlet	57	64	69	74	77	79	78	71	84
BOX HBF 125 T4/T8 (A3:8) F400 (750 RPM - 42°)	Inlet	57	64	69	74	77	79	77	71	84
BOX HBF 125 T4/T8 (A3:8) F400 (1500 RPM - 20°)	Inlet	75	83	90	100	105	108	107	102	112
BOX HBF 125 T4/T8 (A3:8) F400 (1500 RPM - 22°)	Inlet	76	83	90	99	104	107	106	101	111
BOX HBF 125 T4/T8 (A3:8) F400 (1500 RPM - 24°)	Inlet	75	82	89	97	103	105	105	99	110
BOX HBF 125 T4/T8 (A3:8) F400 (1500 RPM - 26°)	Inlet	75	82	88	95	101	103	103	97	108
BOX HBF 125 T4/T8 (A3:8) F400 (1500 RPM - 28°)	Inlet	75	81	88	94	99	102	102	95	107
BOX HBF 125 T4/T8 (A3:8) F400 (1500 RPM - 30°)	Inlet	74	80	87	93	98	100	101	94	105
BOX HBF 125 T4/T8 (A3:8) F400 (1500 RPM - 32°)	Inlet	74	80	86	92	96	99	99	91	104
BOX HBF 125 T4/T8 (A3:8) F400 (1500 RPM - 34°)	Inlet	74	80	86	91	94	96	97	89	102
BOX HBF 125 T4/T8 (A3:8) F400 (1500 RPM - 36°)	Inlet	74	80	86	90	93	95	95	88	101

Sound power Lw dB (A)										
Model		63 Hz	125 Hz	250 Hz	500 Hz	1000 Hz	2000 Hz	4000 Hz	8000 Hz	Total
BOX HBF 125 T4/T8 (A3:8) F400 (1500 RPM - 38°)	Inlet	73	80	85	90	93	95	94	88	101
BOX HBF 125 T4/T8 (A3:8) F400 (1500 RPM - 40°)	Inlet	73	80	85	90	93	95	94	87	100
BOX HBF 125 T4/T8 (A3:8) F400 (1500 RPM - 42°)	Inlet	73	80	85	90	93	95	93	87	100

## erp data

ERP	
Fan type	Axial fan
Installation category	A
Efficiency category	Static
The fan has to be installed with FSC	No

## ERP / 4 poles

Model	Motor power (kW)	Maximum efficiency point data						
		Max. efficiency (%)	Efficiency grade (N) (N)	Air Flow (m3/h)	Ps (Pa)	Pabs (kW)	speed (rpm)	Specific ratio
BOX HBF 45 T4 (A5:6) F400 (20º)	0,75	29,05	39,10	2.491,11	106,33	0,26	-	1,00
BOX HBF 45 T4 (A5:6) F400 (25º)	0,75	30,67	40,22	2.911,16	116,66	0,31	-	1,00
BOX HBF 45 T4 (A5:6) F400 (27,5º)	0,75	31,64	40,72	3.296,92	126,90	0,37	-	1,00
BOX HBF 45 T4 (A5:6) F400 (30º)	0,75	32	40,89	3.459,55	131,58	0,39	-	1,00
BOX HBF 45 T4 (A5:6) F400 (32,5º)	0,75	31,39	40,03	3.702,03	133,26	0,43	-	1,00
BOX HBF 45 T4 (A5:6) F400 (35º)	0,75	30,73	39,12	3.952	134,68	0,47	-	1,00
BOX HBF 45 T4 (A5:6) F400 (37,5º)	0,75	29,91	38,05	4.149,98	136,63	0,52	-	1,00
BOX HBF 45 T4 (A5:6) F400 (40º)	0,75	28,93	36,83	4.344,92	138,11	0,56	-	1,00
BOX HBF 45 T4 (A5:6) F400 (42,5º)	0,75	29,09	36,86	4.679,52	130	0,59	-	1,00
BOX HBF 45 T4 (A5:6) F400 (45º)	0,75	26,21	33,66	5.017,56	123,63	0,67	-	1,00
BOX HBF 50 T4 (A5:6) F400 (20º)	0,75	37,76	46,76	3.770,14	132,89	0,38	-	1,00
BOX HBF 50 T4 (A5:6) F400 (25º)	0,75	37,26	45,81	4.193,11	140,93	0,45	-	1,00
BOX HBF 50 T4 (A5:6) F400 (27,5º)	0,75	36,54	44,65	4.599,56	148,96	0,52	-	1,00
BOX HBF 50 T4 (A5:6) F400 (30º)	0,75	36,12	44,06	4.762,14	152,40	0,56	-	1,00
BOX HBF 50 T4 (A5:6) F400 (32,5º)	0,75	35,23	42,84	5.098,88	157,99	0,63	-	1,00
BOX HBF 50 T4 (A5:6) F400 (35º)	0,75	34,18	41,48	5.440,40	162,59	0,70	-	1,00
BOX HBF 50 T4 (A5:6) F400 (37,5º)	0,75	32,81	39,86	5.744,24	162,46	0,77	-	1,00
BOX HBF 50 T4 (A5:6) F400 (40º)	0,75	33,07	39,86	6.120,76	160,65	0,84	-	1,00
BOX HBF 50 T4 (A5:6) F400 (42,5º)	0,75	32,06	38,72	6.549,62	153,43	0,89	-	1,00
BOX HBF 50 T4 (A5:6) F400 (45º)	0,75	29,27	35,59	7.055,48	146,99	1	-	1,00
BOX HBF 56 T4 (A5:6) F400 (20º)	0,75	45,60	54,38	4.478,93	148,81	0,41	-	1,00
BOX HBF 56 T4 (A5:6) F400 (25º)	0,75	48,78	57,04	5.808,19	148,73	0,50	-	1,00
BOX HBF 56 T4 (A5:6) F400 (30º)	0,75	49,96	57,74	6.778,11	152,82	0,59	-	1,00
BOX HBF 56 T4 (A5:6) F400 (35º)	0,75	46,99	54,14	7.876,22	160,17	0,74	-	1,00
BOX HBF 56 T4 (A5:6) F400 (40º)	1,10	38,65	44,74	9.048,55	169,98	1,09	-	1,00
BOX HBF 56 T4 (A5:6) F400 (45º)	1,50	34,52	40,02	9.736,74	173,85	1,35	-	1,00
BOX HBF 63 T4 (A5:6) F400 (20º)	0,75	58,53	66,55	6.355,92	174,52	0,54	-	1,00
BOX HBF 63 T4 (A5:6) F400 (25º)	0,75	56,44	63,66	7.725,21	182,76	0,72	-	1,00



Model	Motor power (kW)	Maximum efficiency point data						
		Max. efficiency (%)	Efficiency grade (N) (N)	Air Flow (m3/h)	Ps (Pa)	Pabs (kW)	speed (rpm)	Specific ratio
BOX HBF 63 T4 (A5:6) F400 (30°)	1,10	49,58	55,52	9.455,48	213,97	1,15	-	1,00
BOX HBF 63 T4 (A5:6) F400 (35°)	1,50	45,82	51,18	10.626,06	219,74	1,43	-	1,00
BOX HBF 63 T4 (A5:6) F400 (40°)	2,20	42,39	47,13	12.399,99	220,92	1,79	-	1,00
BOX HBF 63 T4 (A5:6) F400 (45°)	2,20	37,31	41,55	13.888,41	205,06	2,14	-	1,00
BOX HBF 71 T4 (A5:6) F400 (20°)	0,75	57,24	64,21	8.318,90	190,43	0,79	-	1,00
BOX HBF 71 T4 (A5:6) F400 (25°)	1,10	51,11	56,91	10.347,46	210,19	1,21	-	1,00
BOX HBF 71 T4 (A5:6) F400 (30°)	1,50	49,69	54,68	12.411,49	229,67	1,63	-	1,00
BOX HBF 71 T4 (A5:6) F400 (35°)	2,20	45,76	49,92	14.677,49	244,74	2,21	-	1,00
BOX HBF 71 T4 (A5:6) F400 (40°)	3	42,05	45,76	16.394,17	241,08	2,60	-	1,00
BOX HBF 71 T4 (A5:6) F400 (45°)	3	36,26	39,41	18.371,79	226,54	3,20	-	1,00
BOX HBF 80 T4 (A5:6) F400 (20°)	2,20	50,90	56,72	9.680,70	227,70	1,21	-	1,00
BOX HBF 80 T4 (A5:6) F400 (25°)	2,20	53,20	58,28	12.281,11	243,37	1,58	-	1,00
BOX HBF 80 T4 (A5:6) F400 (30°)	2,20	56,47	60,42	17.283,68	279,99	2,38	-	1,00
BOX HBF 80 T4 (A5:6) F400 (35°)	3	50,28	53,50	19.802,71	285,92	3,11	-	1,00
BOX HBF 80 T4 (A5:6) F400 (40°)	4	47,95	50,57	22.365,43	298,91	3,87	-	1,00
BOX HBF 80 T4 (A5:6) F400 (45°)	4	40,28	42,28	25.392,14	275,70	4,85	-	1,00
BOX HBF 90 T4 (A3:4) F400 (20°)	3	48,09	51,85	15.955,78	277,88	2,56	-	1,00
BOX HBF 90 T4 (A3:4) F400 (22°)	3	52,40	55,68	17.468,42	328,17	3,04	-	1,00
BOX HBF 90 T4 (A3:4) F400 (24°)	4	51,41	54,28	18.884,96	346,57	3,54	-	1,00
BOX HBF 90 T4 (A3:4) F400 (26°)	4	49,81	52,26	20.381,08	362,27	4,13	-	1,00
BOX HBF 90 T4 (A3:4) F400 (28°)	5,50	48,96	51,04	21.823,74	380,31	4,72	-	1,00
BOX HBF 90 T4 (A3:4) F400 (30°)	5,50	47,76	49,47	23.214,28	399	5,40	-	1,00
BOX HBF 90 T4 (A3:4) F400 (32°)	5,50	46,18	47,67	24.413,97	398,02	5,84	-	1,00
BOX HBF 90 T4 (A3:4) F400 (34°)	7,50	45,22	46,53	25.666,02	396,98	6,24	-	1,00
BOX HBF 90 T4 (A3:4) F400 (36°)	7,50	43,09	44,16	27.097,43	393,25	6,82	-	1,00
BOX HBF 90 T4 (A3:4) F400 (38°)	7,50	40,56	41,36	28.643,25	388,02	7,53	-	1,00
BOX HBF 90 T4 (A3:4) F400 (40°)	11	39,80	40,36	30.598,14	379,44	8,22	-	1,00
BOX HBF 90 T4 (A3:8) F400 (20°)	4	45,66	47,95	18.691,31	366,04	4,36	-	1,00
BOX HBF 90 T4 (A3:8) F400 (22°)	5,50	50,85	52,75	20.492,72	434,30	5,04	-	1,00
BOX HBF 90 T4 (A3:8) F400 (24°)	5,50	49,94	51,43	22.351,51	455,04	5,85	-	1,00
BOX HBF 90 T4 (A3:8) F400 (26°)	7,50	49,93	51,08	24.309,22	475,44	6,64	-	1,00
BOX HBF 90 T4 (A3:8) F400 (28°)	7,50	48,96	49,73	26.219,52	496,13	7,60	-	1,00
BOX HBF 90 T4 (A3:8) F400 (30°)	11	48,58	49,03	28.118,79	518,15	8,54	-	1,00
BOX HBF 90 T4 (A3:8) F400 (32°)	11	47,05	47,23	29.635,83	527,28	9,42	-	1,00
BOX HBF 90 T4 (A3:8) F400 (34°)	11	45,31	45,37	31.030,42	536,47	10,36	-	1,00
BOX HBF 90 T4 (A3:8) F400 (36°)	11	44,02	44,01	32.403,99	548,99	11,32	-	1,00
BOX HBF 90 T4 (A3:8) F400 (38°)	15	43,36	43,29	33.748,52	564,61	12,17	-	1,00
BOX HBF 90 T4 (A3:8) F400 (40°)	15	41,87	41,74	34.989,69	579,72	13,30	-	1,00

Model	Motor power (kW)	Maximum efficiency point data						
		Max. efficiency (%)	Efficiency grade (N) (N)	Air Flow (m3/h)	Ps (Pa)	Pabs (kW)	speed (rpm)	Specific ratio
BOX HBF 90 T4 (A3:8) F400 (42º)	15	40,32	40,11	36.672,46	582,67	14,53	-	1,00
BOX HBF 100 T4 (A3:4) F400 (20º)	5,50	54,31	56,80	22.194,39	356,83	4,07	-	1,00
BOX HBF 100 T4 (A3:4) F400 (22º)	5,50	59,38	61,51	23.962,35	411,40	4,63	-	1,00
BOX HBF 100 T4 (A3:4) F400 (24º)	5,50	57,70	59,48	25.849,24	421,62	5,26	-	1,00
BOX HBF 100 T4 (A3:4) F400 (26º)	5,50	56,12	57,55	27.859,73	431,55	5,97	-	1,00
BOX HBF 100 T4 (A3:4) F400 (28º)	7,50	55,38	56,52	29.732,15	443,68	6,63	-	1,00
BOX HBF 100 T4 (A3:4) F400 (30º)	7,50	53,61	54,44	31.667,92	453,69	7,46	-	1,00
BOX HBF 100 T4 (A3:4) F400 (32º)	11	52,21	52,78	33.359,85	461,34	8,19	-	1,00
BOX HBF 100 T4 (A3:4) F400 (34º)	11	50,33	50,62	35.182,49	468,19	9,07	-	1,00
BOX HBF 100 T4 (A3:4) F400 (36º)	11	47,95	48,03	37.414,86	466,31	10,04	-	1,00
BOX HBF 100 T4 (A3:4) F400 (38º)	11	46,64	46,64	40.156,68	457,72	11,10	-	1,00
BOX HBF 100 T4 (A3:4) F400 (40º)	15	45,09	45,02	42.939,43	451,39	12,17	-	1,00
BOX HBF 100 T4 (A3:4) F400 (42º)	15	40,34	40,19	47.442,20	410,21	13,47	-	1,00
BOX HBF 100 T4 (A3:8) F400 (20º)	7,50	53,05	53,85	26.682,88	528,77	7,53	-	1,00
BOX HBF 100 T4 (A3:8) F400 (22º)	11	59,14	59,67	28.932,88	598,16	8,30	-	1,00
BOX HBF 100 T4 (A3:8) F400 (24º)	11	57,84	58,08	31.096,46	605,57	9,24	-	1,00
BOX HBF 100 T4 (A3:8) F400 (26º)	11	56,33	56,39	33.251,27	615,16	10,31	-	1,00
BOX HBF 100 T4 (A3:8) F400 (28º)	11	54,74	54,72	35.417,64	622,91	11,47	-	1,00
BOX HBF 100 T4 (A3:8) F400 (30º)	15	53,79	53,70	37.563,11	630,92	12,57	-	1,00
BOX HBF 100 T4 (A3:8) F400 (32º)	15	52,25	52,07	39.660,55	649,91	13,96	-	1,00
BOX HBF 100 T4 (A3:8) F400 (34º)	15	50,59	50,33	41.700,32	668,77	15,50	-	1,00
BOX HBF 100 T4 (A3:8) F400 (36º)	18,50	49,21	48,88	43.871,45	686,20	17,08	-	1,00
BOX HBF 100 T4 (A3:8) F400 (38º)	18,50	47,78	47,37	45.992,03	703,90	18,77	-	1,00
BOX HBF 100 T4 (A3:8) F400 (40º)	22	46,26	45,77	48.308	719,29	20,65	-	1,00
BOX HBF 100 T4 (A3:8) F400 (42º)	22	44,22	43,67	51.053,71	712,96	22,68	-	1,00
BOX HBF 112 T4 (A3:4) F400 (20º)	7,50	56,89	58,67	18.300	572,72	5,27	-	1,00
BOX HBF 112 T4 (A3:4) F400 (22º)	7,50	58,51	59,69	30.542,16	455,36	6,54	-	1,00
BOX HBF 112 T4 (A3:4) F400 (24º)	7,50	57,69	58,55	34.380,35	445,89	7,39	-	1,00
BOX HBF 112 T4 (A3:4) F400 (26º)	11	57,59	58,16	37.870,79	447,18	8,20	-	1,00
BOX HBF 112 T4 (A3:4) F400 (28º)	11	56,91	57,18	40.862,52	458,02	9,16	-	1,00
BOX HBF 112 T4 (A3:4) F400 (30º)	11	56,25	56,32	43.399,71	474,39	10,17	-	1,00
BOX HBF 112 T4 (A3:4) F400 (32º)	11	54,48	54,48	45.916,32	481,99	11,26	-	1,00
BOX HBF 112 T4 (A3:4) F400 (34º)	15	52,65	52,56	48.439,72	490,42	12,47	-	1,00
BOX HBF 112 T4 (A3:4) F400 (36º)	15	49,58	49,41	51.224,50	485,51	13,82	-	1,00
BOX HBF 112 T4 (A3:4) F400 (38º)	15	47,48	47,23	57.078,40	451,12	15,27	-	1,00
BOX HBF 112 T4 (A3:4) F400 (40º)	18,50	44,66	44,35	60.435,65	436,73	16,64	-	1,00
BOX HBF 112 T4 (A3:8) F400 (20º)	11	57,06	57,12	32.770,46	642,99	10,29	-	1,00
BOX HBF 112 T4 (A3:8) F400 (22º)	11	62,14	62,13	36.629,30	686,10	11,28	-	1,00

Model	Motor power (kW)	Maximum efficiency point data						
		Max. efficiency (%)	Efficiency grade (N) (N)	Air Flow (m3/h)	Ps (Pa)	Pabs (kW)	speed (rpm)	Specific ratio
BOX HBF 112 T4 (A3:8) F400 (24 <sup>o</sup> )	15	61,81	61,72	40.603,20	674,28	12,36	-	1,00
BOX HBF 112 T4 (A3:8) F400 (26 <sup>o</sup> )	15	60,50	60,33	44.666,32	665,08	13,76	-	1,00
BOX HBF 112 T4 (A3:8) F400 (28 <sup>o</sup> )	15	59,19	58,94	48.542,97	663,39	15,30	-	1,00
BOX HBF 112 T4 (A3:8) F400 (30 <sup>o</sup> )	18,50	58,45	58,13	52.209,90	667,35	16,84	-	1,00
BOX HBF 112 T4 (A3:8) F400 (32 <sup>o</sup> )	18,50	56,39	55,97	55.017,35	695,59	18,97	-	1,00
BOX HBF 112 T4 (A3:8) F400 (34 <sup>o</sup> )	22	54,48	53,97	58.008,26	720,74	21,27	-	1,00
BOX HBF 112 T4 (A3:8) F400 (36 <sup>o</sup> )	22	52,76	52,18	60.935,16	734,95	23,37	-	1,00
BOX HBF 112 T4 (A3:8) F400 (38 <sup>o</sup> )	30	51,41	50,78	63.739,94	739,44	25,08	-	1,00
BOX HBF 112 T4 (A3:8) F400 (40 <sup>o</sup> )	30	51	50,31	66.443,30	746,01	27,25	-	1,00
BOX HBF 112 T4 (A3:8) F400 (42 <sup>o</sup> )	30	48,22	47,45	72.330,57	711,69	29,92	-	1,00
BOX HBF 125 T4 (A3:4) F400 (20 <sup>o</sup> )	11	57,35	57,78	24.700	700,21	8,63	-	1,00
BOX HBF 125 T4 (A3:4) F400 (22 <sup>o</sup> )	11	57,36	57,39	41.357,73	540,18	10,72	-	1,00
BOX HBF 125 T4 (A3:4) F400 (24 <sup>o</sup> )	15	56,97	56,91	46.668,70	526,27	11,99	-	1,00
BOX HBF 125 T4 (A3:4) F400 (26 <sup>o</sup> )	15	56,50	56,35	51.229,46	530,95	13,42	-	1,00
BOX HBF 125 T4 (A3:4) F400 (28 <sup>o</sup> )	15	55,59	55,35	55.317,73	543,13	15,05	-	1,00
BOX HBF 125 T4 (A3:4) F400 (30 <sup>o</sup> )	18,50	55,35	55,04	58.653,69	563,55	16,59	-	1,00
BOX HBF 125 T4 (A3:4) F400 (32 <sup>o</sup> )	18,50	53,74	53,35	62.010,38	573,01	18,33	-	1,00
BOX HBF 125 T4 (A3:4) F400 (34 <sup>o</sup> )	22	51,46	50,98	65.637,51	581,45	20,49	-	1,00
BOX HBF 125 T4 (A3:4) F400 (36 <sup>o</sup> )	22	48,46	47,91	69.151,38	577,59	22,70	-	1,00
BOX HBF 125 T4 (A3:4) F400 (38 <sup>o</sup> )	30	46,75	46,12	77.027,17	536,30	24,86	-	1,00
BOX HBF 125 T4 (A3:4) F400 (40 <sup>o</sup> )	30	43,73	43,03	81.637,62	519,11	27,28	-	1,00
BOX HBF 125 T4 (A3:8) F400 (20 <sup>o</sup> )	18,50	57,88	57,56	44.261,47	787,70	16,78	-	1,00
BOX HBF 125 T4 (A3:8) F400 (22 <sup>o</sup> )	18,50	61,26	60,87	49.676,80	811,37	18,33	-	1,00
BOX HBF 125 T4 (A3:8) F400 (24 <sup>o</sup> )	22	60,36	59,89	54.991,48	798,35	20,32	-	1,00
BOX HBF 125 T4 (A3:8) F400 (26 <sup>o</sup> )	22	59,09	58,54	60.245,29	792,18	22,60	-	1,00
BOX HBF 125 T4 (A3:8) F400 (28 <sup>o</sup> )	30	58,26	57,63	65.458,88	790,73	24,97	-	1,00
BOX HBF 125 T4 (A3:8) F400 (30 <sup>o</sup> )	30	57,12	56,41	70.166,20	798,20	27,60	-	1,00
BOX HBF 125 T4 (A3:8) F400 (32 <sup>o</sup> )	30	55,32	54,51	74.313,29	828,18	31,09	-	1,00
BOX HBF 125 T4 (A3:8) F400 (34 <sup>o</sup> )	37	53,53	52,65	78.065,57	858,03	34,65	-	1,00
BOX HBF 125 T4 (A3:8) F400 (36 <sup>o</sup> )	37	51,96	51	82.466,57	872,89	38,14	-	1,00
BOX HBF 125 T4 (A3:8) F400 (38 <sup>o</sup> )	45	50,50	49,48	86.364,05	877,23	41,14	-	1,00
BOX HBF 125 T4 (A3:8) F400 (40 <sup>o</sup> )	45	49,96	48,87	89.685,29	885,60	44,66	-	1,00
BOX HBF 125 T4 (A3:8) F400 (42 <sup>o</sup> )	45	47,15	45,99	97.487,97	845,08	49,03	-	1,00

**ERP / 6 poles**

Model	Motor power (kW)	Maximum efficiency point data						
		Max. efficiency (%)	Efficiency grade (N) (N)	Air Flow (m3/h)	Ps (Pa)	Pabs (kW)	speed (rpm)	Specific ratio
BOX HBF 50 T6 (A5:6) F400 (25º)	0,75	20,45	32,09	2.361,61	44,83	0,14	-	1,00
BOX HBF 50 T6 (A5:6) F400 (27,5º)	0,75	20,95	32,48	2.477,40	45,55	0,15	-	1,00
BOX HBF 50 T6 (A5:6) F400 (30º)	0,75	21,92	33,19	2.720	47,94	0,17	-	1,00
BOX HBF 50 T6 (A5:6) F400 (32,5º)	0,75	22,01	33,09	2.907,09	48,24	0,18	-	1,00
BOX HBF 50 T6 (A5:6) F400 (35º)	0,75	21,93	32,81	3.101,82	48,51	0,19	-	1,00
BOX HBF 50 T6 (A5:6) F400 (37,5º)	0,75	21,34	32,06	3.305,09	47,40	0,20	-	1,00
BOX HBF 50 T6 (A5:6) F400 (40º)	0,75	20,58	31,10	3.512,84	46,51	0,22	-	1,00
BOX HBF 50 T6 (A5:6) F400 (42,5º)	0,75	18,60	28,84	3.736,18	43,43	0,24	-	1,00
BOX HBF 56 T6 (A5:6) F400 (20º)	0,75	30,74	41,79	2.985,99	66,14	0,18	-	1,00
BOX HBF 56 T6 (A5:6) F400 (25º)	0,75	34,88	45,56	3.872,15	66,10	0,21	-	1,00
BOX HBF 56 T6 (A5:6) F400 (30º)	0,75	37,52	47,86	4.518,74	67,92	0,23	-	1,00
BOX HBF 56 T6 (A5:6) F400 (35º)	0,75	37,62	47,49	5.250,82	71,19	0,28	-	1,00
BOX HBF 56 T6 (A5:6) F400 (40º)	0,75	33,18	42,19	6.032,36	75,54	0,38	-	1,00
BOX HBF 56 T6 (A5:6) F400 (45º)	0,75	30,38	38,86	6.491,16	77,27	0,46	-	1,00
BOX HBF 63 T6 (A5:6) F400 (20º)	0,75	42,90	53,41	4.237,23	77,56	0,22	-	1,00
BOX HBF 63 T6 (A5:6) F400 (25º)	0,75	44,67	54,61	5.150,08	81,23	0,27	-	1,00
BOX HBF 63 T6 (A5:6) F400 (30º)	0,75	42,92	51,80	6.303,64	95,10	0,39	-	1,00
BOX HBF 63 T6 (A5:6) F400 (35º)	0,75	40,52	48,88	7.084,04	97,66	0,48	-	1,00
BOX HBF 63 T6 (A5:6) F400 (40º)	0,75	37,24	44,97	8.267,83	98,18	0,60	-	1,00
BOX HBF 63 T6 (A5:6) F400 (45º)	0,75	33,26	40,52	9.258,93	91,14	0,71	-	1,00
BOX HBF 71 T6 (A5:6) F400 (20º)	0,75	46,42	56,16	5.545,82	84,64	0,29	-	1,00
BOX HBF 71 T6 (A5:6) F400 (25º)	0,75	44,63	53,40	6.898,31	93,42	0,41	-	1,00
BOX HBF 71 T6 (A5:6) F400 (30º)	0,75	44,66	52,69	8.274,35	102,07	0,54	-	1,00
BOX HBF 71 T6 (A5:6) F400 (35º)	0,75	40,87	48,06	9.784,98	108,77	0,73	-	1,00
BOX HBF 71 T6 (A5:6) F400 (40º)	0,75	37,68	44,42	10.928,58	107,15	0,86	-	1,00
BOX HBF 71 T6 (A5:6) F400 (45º)	0,75	32,30	38,46	12.247,88	100,69	1,06	-	1,00
BOX HBF 80 T6 (A5:6) F400 (20º)	0,75	43,60	52,33	6.453,80	101,20	0,42	-	1,00
BOX HBF 80 T6 (A5:6) F400 (25º)	0,75	46,30	54,33	8.187,39	108,16	0,54	-	1,00
BOX HBF 80 T6 (A5:6) F400 (30º)	0,75	51,10	58,09	11.446,42	125,31	0,78	-	1,00
BOX HBF 80 T6 (A5:6) F400 (35º)	1,10	46,50	52,83	13.171,67	127,37	1	-	1,00
BOX HBF 80 T6 (A5:6) F400 (40º)	1,10	43,85	49,56	14.924,27	132,73	1,25	-	1,00
BOX HBF 80 T6 (A5:6) F400 (45º)	1,50	37,85	43,02	16.929,39	122,52	1,53	-	1,00
BOX HBF 90 T6 (A3:4) F400 (20º)	1,50	43,17	50,20	10.372,34	115,88	0,77	-	1,00
BOX HBF 90 T6 (A3:4) F400 (22º)	1,50	48,09	54,71	11.334,84	137,59	0,90	-	1,00
BOX HBF 90 T6 (A3:4) F400 (24º)	1,50	47,35	53,56	12.281,93	144,82	1,05	-	1,00
BOX HBF 90 T6 (A3:4) F400 (26º)	1,50	46,38	52,19	13.207,65	152,08	1,21	-	1,00
BOX HBF 90 T6 (A3:4) F400 (28º)	1,50	45,28	50,72	14.055,75	160,37	1,39	-	1,00
BOX HBF 90 T6 (A3:4) F400 (30º)	1,50	44,07	49,13	15.018,14	167,35	1,59	-	1,00
BOX HBF 90 T6 (A3:4) F400 (32º)	1,50	42,45	47,29	15.824,99	166,38	1,72	-	1,00

Model	Motor power (kW)	Maximum efficiency point data						
		Max. efficiency (%)	Efficiency grade (N) (N)	Air Flow (m3/h)	Ps (Pa)	Pabs (kW)	speed (rpm)	Specific ratio
BOX HBF 90 T6 (A3:4) F400 (34º)	2,20	42,12	46,81	16.659,62	166,43	1,82	-	1,00
BOX HBF 90 T6 (A3:4) F400 (36º)	2,20	40,22	44,67	17.612	164,58	1,99	-	1,00
BOX HBF 90 T6 (A3:4) F400 (38º)	2,20	37,96	42,15	18.587,23	162,78	2,19	-	1,00
BOX HBF 90 T6 (A3:4) F400 (40º)	2,20	37,01	40,92	19.857,45	159,96	2,42	-	1,00
BOX HBF 90 T6 (A3:4) F400 (42º)	3	34,55	38,25	21.820,91	147,55	2,61	-	1,00
BOX HBF 90 T6 (A3:8) F400 (20º)	1,50	42,52	48,20	12.101,08	153,60	1,27	-	1,00
BOX HBF 90 T6 (A3:8) F400 (22º)	1,50	47,13	52,39	13.303,16	181,23	1,48	-	1,00
BOX HBF 90 T6 (A3:8) F400 (24º)	1,50	46,19	51,03	14.534,86	190,08	1,72	-	1,00
BOX HBF 90 T6 (A3:8) F400 (26º)	2,20	46,39	50,92	15.689,43	200,22	1,93	-	1,00
BOX HBF 90 T6 (A3:8) F400 (28º)	2,20	45,78	49,93	16.980,47	208,34	2,21	-	1,00
BOX HBF 90 T6 (A3:8) F400 (30º)	2,20	44,88	48,68	18.213,61	216,99	2,51	-	1,00
BOX HBF 90 T6 (A3:8) F400 (32º)	3	44,24	47,82	19.215,68	221,40	2,73	-	1,00
BOX HBF 90 T6 (A3:8) F400 (34º)	3	42,60	45,92	20.092,17	226,04	3	-	1,00
BOX HBF 90 T6 (A3:8) F400 (36º)	3	41,35	44,43	20.986,18	230,56	3,28	-	1,00
BOX HBF 90 T6 (A3:8) F400 (38º)	4	40,75	43,64	21.866,75	236,59	3,52	-	1,00
BOX HBF 90 T6 (A3:8) F400 (40º)	4	39,47	42,11	22.653,78	243,30	3,84	-	1,00
BOX HBF 90 T6 (A3:8) F400 (42º)	4	37,91	40,31	23.711,75	245,06	4,20	-	1,00
BOX HBF 100 T6 (A3:4) F400 (20º)	1,50	50,17	56,01	14.394,01	149,20	1,19	-	1,00
BOX HBF 100 T6 (A3:4) F400 (22º)	1,50	54,81	60,30	15.545,02	171,96	1,36	-	1,00
BOX HBF 100 T6 (A3:4) F400 (24º)	1,50	53,41	58,55	16.770,57	176,86	1,55	-	1,00
BOX HBF 100 T6 (A3:4) F400 (26º)	1,50	51,73	56,52	18.003,41	181,34	1,76	-	1,00
BOX HBF 100 T6 (A3:4) F400 (28º)	2,20	51,68	56,20	19.350,37	185,52	1,93	-	1,00
BOX HBF 100 T6 (A3:4) F400 (30º)	2,20	50,16	54,37	20.487,93	190,81	2,17	-	1,00
BOX HBF 100 T6 (A3:4) F400 (32º)	2,20	48,28	52,20	21.706,82	192,99	2,41	-	1,00
BOX HBF 100 T6 (A3:4) F400 (34º)	3	47,18	50,86	22.815,46	196,23	2,63	-	1,00
BOX HBF 100 T6 (A3:4) F400 (36º)	3	45,04	48,45	24.161,47	196,20	2,90	-	1,00
BOX HBF 100 T6 (A3:4) F400 (38º)	3	42,46	45,58	25.798,53	193,20	3,22	-	1,00
BOX HBF 100 T6 (A3:4) F400 (40º)	4	42,51	45,40	27.969,69	188,66	3,52	-	1,00
BOX HBF 100 T6 (A3:4) F400 (42º)	4	37,83	40,44	30.782,97	171,52	3,89	-	1,00
BOX HBF 100 T6 (A3:8) F400 (20º)	2,20	49,65	53,83	17.337,10	220,98	2,19	-	1,00
BOX HBF 100 T6 (A3:8) F400 (22º)	2,20	54,72	58,61	18.711,45	252,11	2,44	-	1,00
BOX HBF 100 T6 (A3:8) F400 (24º)	3	54,40	58,04	20.204,35	253,87	2,68	-	1,00
BOX HBF 100 T6 (A3:8) F400 (26º)	3	52,85	56,18	21.565,89	257,65	2,99	-	1,00
BOX HBF 100 T6 (A3:8) F400 (28º)	3	51,34	54,38	22.932,51	261,44	3,32	-	1,00
BOX HBF 100 T6 (A3:8) F400 (30º)	4	50,61	53,41	24.326,84	264,59	3,63	-	1,00
BOX HBF 100 T6 (A3:8) F400 (32º)	4	49,16	51,67	25.593,12	273,88	4,03	-	1,00
BOX HBF 100 T6 (A3:8) F400 (34º)	4	47,66	49,88	27.052,34	280,58	4,48	-	1,00
BOX HBF 100 T6 (A3:8) F400 (36º)	5,50	46,68	48,66	28.448,08	287,70	4,90	-	1,00

Model	Motor power (kW)	Maximum efficiency point data						
		Max. efficiency (%)	Efficiency grade (N) (N)	Air Flow (m3/h)	Ps (Pa)	Pabs (kW)	speed (rpm)	Specific ratio
BOX HBF 100 T6 (A3:8) F400 (38º)	5,50	45,25	46,97	29.817,81	295,29	5,39	-	1,00
BOX HBF 100 T6 (A3:8) F400 (40º)	5,50	43,85	45,30	31.376,77	301,29	5,93	-	1,00
BOX HBF 100 T6 (A3:8) F400 (42º)	7,50	42,58	43,82	33.124,25	298,63	6,40	-	1,00
BOX HBF 112 T6 (A3:4) F400 (20º)	2,20	52,70	57,84	11.800	241,17	1,55	-	1,00
BOX HBF 112 T6 (A3:4) F400 (22º)	2,20	54,66	59,23	19.562,18	193,94	1,91	-	1,00
BOX HBF 112 T6 (A3:4) F400 (24º)	2,20	53,95	58,19	22.280,91	187,04	2,15	-	1,00
BOX HBF 112 T6 (A3:4) F400 (26º)	2,20	53,36	57,28	24.525,18	187,91	2,41	-	1,00
BOX HBF 112 T6 (A3:4) F400 (28º)	3	53,39	57,04	26.491,83	192,02	2,65	-	1,00
BOX HBF 112 T6 (A3:4) F400 (30º)	3	52,78	56,15	28.158,01	198,68	2,94	-	1,00
BOX HBF 112 T6 (A3:4) F400 (32º)	3	51,08	54,17	29.720,12	202,34	3,26	-	1,00
BOX HBF 112 T6 (A3:4) F400 (34º)	4	49,71	52,54	31.370,35	206,44	3,60	-	1,00
BOX HBF 112 T6 (A3:4) F400 (36º)	4	46,68	49,22	33.191,85	203,79	3,99	-	1,00
BOX HBF 112 T6 (A3:4) F400 (38º)	4	44,76	47,03	36.937,67	189,69	4,41	-	1,00
BOX HBF 112 T6 (A3:4) F400 (40º)	5,50	42,32	44,36	39.054,54	183,68	4,77	-	1,00
BOX HBF 112 T6 (A3:4) F400 (42º)	5,50	36,69	38,49	43.100	160,98	5,23	-	1,00
BOX HBF 112 T6 (A3:8) F400 (20º)	3	53,70	57,04	21.268,06	270,25	2,98	-	1,00
BOX HBF 112 T6 (A3:8) F400 (22º)	3	58,40	61,49	23.817,12	287,07	3,26	-	1,00
BOX HBF 112 T6 (A3:8) F400 (24º)	4	58,14	60,98	26.404,43	281,19	3,57	-	1,00
BOX HBF 112 T6 (A3:8) F400 (26º)	4	56,91	59,46	28.917,33	279,32	3,98	-	1,00
BOX HBF 112 T6 (A3:8) F400 (28º)	4	55,77	58,02	31.510,82	277,87	4,42	-	1,00
BOX HBF 112 T6 (A3:8) F400 (30º)	5,50	55,35	57,36	33.766,81	280,75	4,83	-	1,00
BOX HBF 112 T6 (A3:8) F400 (32º)	5,50	53,56	55,25	35.671,31	292,31	5,44	-	1,00
BOX HBF 112 T6 (A3:8) F400 (34º)	5,50	51,64	53,01	37.578,51	302,47	6,10	-	1,00
BOX HBF 112 T6 (A3:8) F400 (36º)	7,50	50,81	51,97	39.389,52	308,78	6,59	-	1,00
BOX HBF 112 T6 (A3:8) F400 (38º)	7,50	50,36	51,32	41.151,83	311,60	7,12	-	1,00
BOX HBF 112 T6 (A3:8) F400 (40º)	7,50	48,78	49,51	43.015,42	313,12	7,74	-	1,00
BOX HBF 112 T6 (A3:8) F400 (42º)	11	46,47	46,95	46.814,99	299,03	8,45	-	1,00
BOX HBF 125 T6 (A3:4) F400 (20º)	3	53,80	57,62	16.000	294,06	2,50	-	1,00
BOX HBF 125 T6 (A3:4) F400 (22º)	3	53,77	57	26.654,60	227,73	3,10	-	1,00
BOX HBF 125 T6 (A3:4) F400 (24º)	4	53,78	56,71	30.129,23	222,05	3,46	-	1,00
BOX HBF 125 T6 (A3:4) F400 (26º)	4	53,18	55,80	33.080,89	223,68	3,88	-	1,00
BOX HBF 125 T6 (A3:4) F400 (28º)	4	52,38	54,69	35.846,93	227,96	4,34	-	1,00
BOX HBF 125 T6 (A3:4) F400 (30º)	5,50	52,48	54,54	37.887,16	237,03	4,75	-	1,00
BOX HBF 125 T6 (A3:4) F400 (32º)	5,50	50,91	52,70	40.142,76	240,63	5,26	-	1,00
BOX HBF 125 T6 (A3:4) F400 (34º)	5,50	48,70	50,17	42.431,82	244,37	5,89	-	1,00
BOX HBF 125 T6 (A3:4) F400 (36º)	7,50	46,72	47,97	44.903,02	241,95	6,40	-	1,00
BOX HBF 125 T6 (A3:4) F400 (38º)	7,50	44,94	45,92	49.891,55	225,54	7,05	-	1,00
BOX HBF 125 T6 (A3:4) F400 (40º)	7,50	41,77	42,48	53.076,30	216,91	7,76	-	1,00

Model	Motor power (kW)	Maximum efficiency point data						
		Max. efficiency (%)	Efficiency grade (N) (N)	Air Flow (m <sup>3</sup> /h)	Ps (Pa)	Pabs (kW)	speed (rpm)	Specific ratio
BOX HBF 125 T6 (A3:8) F400 (20 <sup>º</sup> )	5,50	54,82	56,84	28.716,26	329,81	4,81	-	1,00
BOX HBF 125 T6 (A3:8) F400 (22 <sup>º</sup> )	5,50	58,20	59,98	32.165,87	341,03	5,25	-	1,00
BOX HBF 125 T6 (A3:8) F400 (24 <sup>º</sup> )	5,50	57,14	58,63	35.561,95	335,93	5,84	-	1,00
BOX HBF 125 T6 (A3:8) F400 (26 <sup>º</sup> )	7,50	56,96	58,22	39.094,02	331,72	6,38	-	1,00
BOX HBF 125 T6 (A3:8) F400 (28 <sup>º</sup> )	7,50	55,88	56,85	42.485,61	331,26	7,08	-	1,00
BOX HBF 125 T6 (A3:8) F400 (30 <sup>º</sup> )	7,50	54,75	55,44	45.722,51	332,64	7,85	-	1,00
BOX HBF 125 T6 (A3:8) F400 (32 <sup>º</sup> )	11	53,25	53,63	48.156,13	347,56	8,78	-	1,00
BOX HBF 125 T6 (A3:8) F400 (34 <sup>º</sup> )	11	51,48	51,55	50.671,24	360,10	9,81	-	1,00
BOX HBF 125 T6 (A3:8) F400 (36 <sup>º</sup> )	11	49,88	49,91	53.155,55	367,62	10,78	-	1,00
BOX HBF 125 T6 (A3:8) F400 (38 <sup>º</sup> )	11	48,38	48,35	55.698,31	369,31	11,64	-	1,00
BOX HBF 125 T6 (A3:8) F400 (40 <sup>º</sup> )	15	48,51	48,42	58.270,22	371,52	12,52	-	1,00
BOX HBF 125 T6 (A3:8) F400 (42 <sup>º</sup> )	15	45,98	45,82	63.098,04	356,38	13,73	-	1,00