

POWER SUPPLY SYSTEMS

info@fracksystems.se
+46 854063722

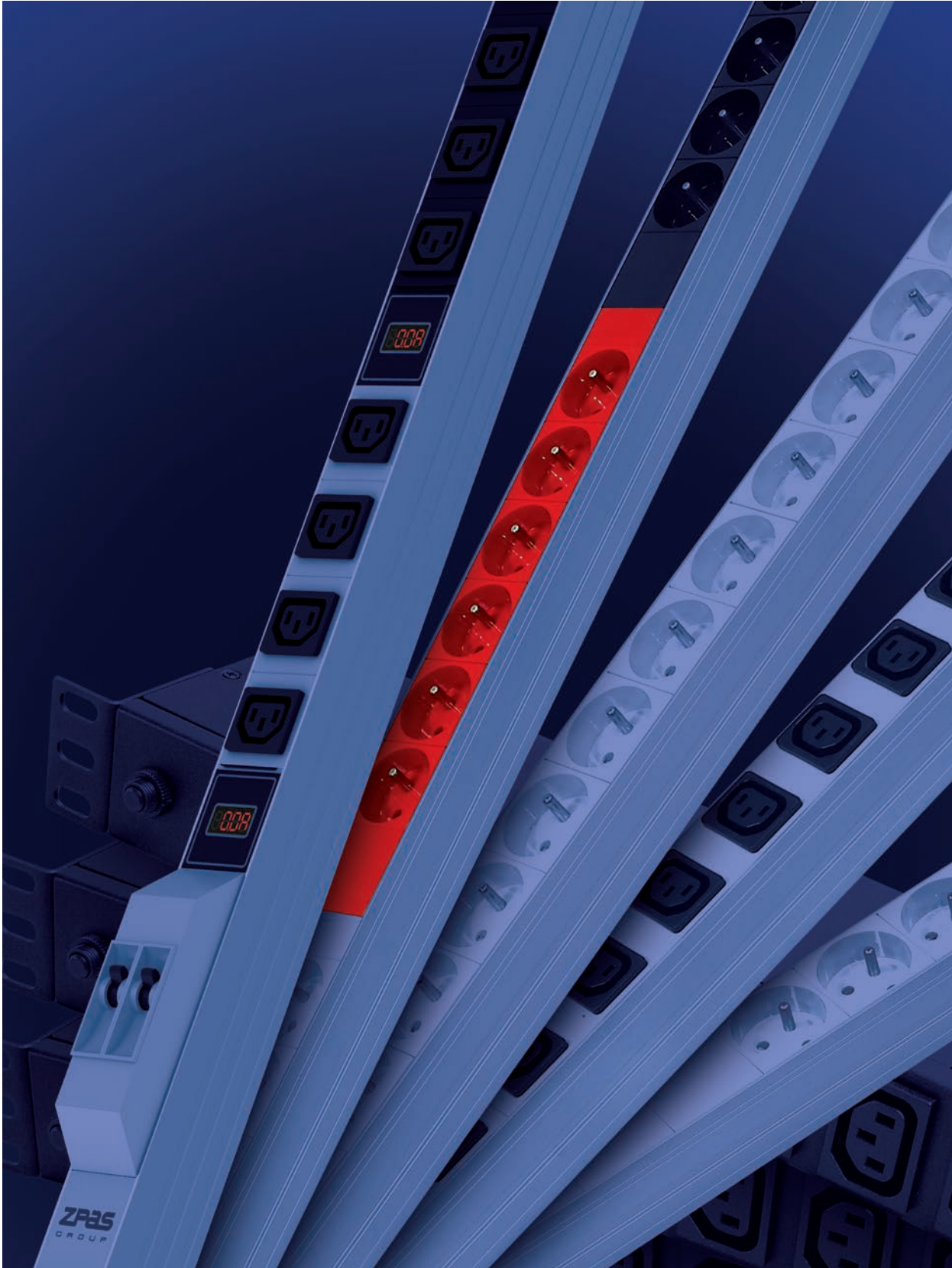

POWER SUPPLY SYSTEMS

POWER SUPPLY SYSTEMS



LZI-30/9



**19" power strip,
possible to be mounted
at 12 different angles**

Single-phase power strips 16 A

Characteristics

Anodized aluminium body, in natural colour.
Plastic elements: light-grey similar to RAL 7035.
Dimensions: height/width 44 mm, depth 44 mm (protruding elements increase the depth to 70 mm), length according to the table. Removable metal mounting brackets for installing the strip in four directions.
LZI-30/9 strip can be mounted at various angles, 12 positions of set up regulated by 30° turns.

TECHNICAL DATA

Nominal voltage.....230 V AC
Maximum load16 A / 3680 W
Protection degreeIP 20
Supply cable3 m, black, conductor section 1.5 mm²
(other lengths within of 2-5 m scope, available on request)

Installation	Power strip type	Length without mounting brackets [mm]	Features									Catalogue number	
			Check lamp	Illuminated switch	Surge arrester	RFI noise filter	Circuit breaker MCB-16	Ammeter	Number of UTE sockets	Number of IEC C13 sockets	Number of IEC C19 sockets		
19" 1U	LZI-30/9	431								9			WZ-LZ130-09-00-000
	LZ-30F	431		x	x	x				5			WZ-LZ30-F0-00-000
	LZ-114	431	x								7		WZ-LZ11-40-00-000
	LZ-211	431		x							6		WZ-LZ21-10-00-000
	LZ-214	431		x							7		WZ-LZ21-40-00-000
	LZ-312	431	x					x			3	2	WZ-LZ31-20-00-000
	LZ-165	431							x	8			WZ-LZ16-50-00-000
vertical 0U	LZ-221	603		x						12			WZ-LZ22-10-00-000
	LZ-521	860	x		x	x	x			9	1		WZ-LZ52-10-00-000
	LZ-131	861	x							18			WZ-LZ13-10-00-000
	LZ-231	861		x						18			WZ-LZ23-10-00-000
	LZ-331	990	x					x		15	3		WZ-LZ33-10-00-000
	LZ-531	990			x	x	x			15	1		WZ-LZ53-10-00-000
	LZ-532	1033	x		x	x	x			12	4		WZ-LZ53-20-00-000
	LZ-166	1076									20	4	WZ-LZ16-60-00-000
	LZ-167	560									10	2	WZ-LZ16-70-00-000
	LZ-168	560									12		WZ-LZ16-80-00-000
	LZ-169	732									15		WZ-LZ16-90-00-000

Type of sockets						
Standard sockets			Sockets on request			
UTE (French type) 230 V, 16 A	IEC 60320 C13 230 V, 10 A	IEC 60320 C19 230 V, 16 A	Schuko 230 V, 16 A	IEC 60320 C13 230 V, 10 A with lock	IEC 60320 C13 230 V, 10 A with fuse	IEC 60320 C13, 230 V, 10 A with fuse and check lamp

POWER SUPPLY SYSTEMS

Power strips mounted in 4 directions

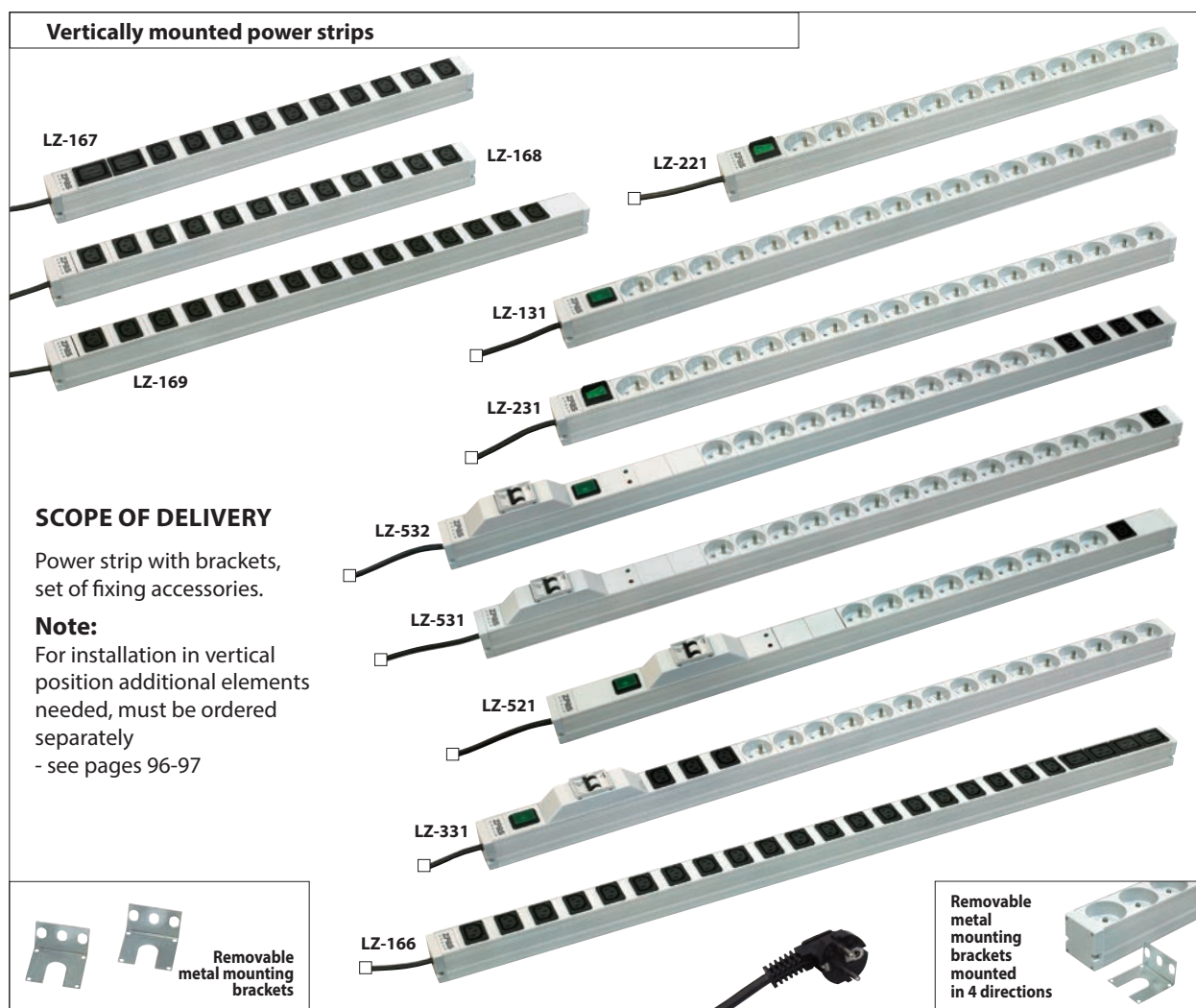
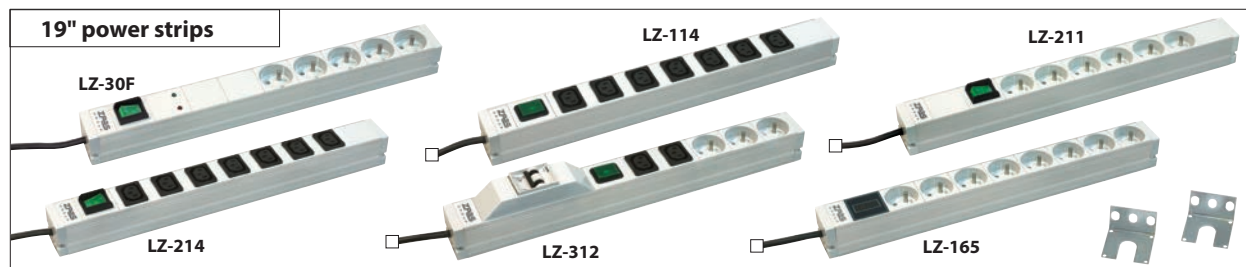

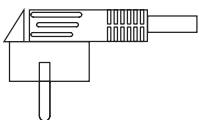
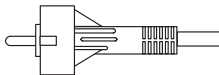
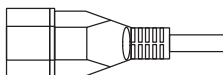
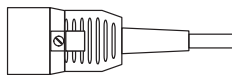
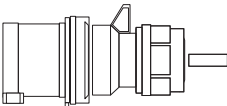
Type of plugs				
Standard plug	Plugs on request			
				
Angle Unischuko 230 V, 16 A	Straight Unischuko 230 V, 16 A	IEC 60320 C14 230 V, 10 A	IEC 60320 C20 230 V, 16 A	IEC 60309 230 V, 16 A

POWER SUPPLY SYSTEMS



Single-phase power strips 32 A

Characteristics

Anodized aluminium body, in natural colour (body of LZ-322 power strip is made of sheet steel, powder painted in RAL 7035). Plastic elements: light-grey (similar to RAL 7035) or black (similar to RAL 9005). Dimensions: height/width 44 mm, depth 70 mm, length according to the table. Strips mounted in 4 directions (LZ-322 mounted in 2 directions).



TECHNICAL DATA



Nominal voltage..... 230 V AC
 Maximum load 32 A / 7360 W
 Protection degree IP 20
 Supply cable 3 m, white, conductor section 4 mm²
 (other lengths within of 2-5 m scope, available on request)



SCOPE OF DELIVERY

Power strip with brackets, set of fixing accessories.
 Note: For installation in vertical position additional elements needed, must be ordered separately - see pages 96-97.

Installation	Power strip type	Lenght without mounting brackets [mm]	Features				Catalogue number		
			Circuit breaker MCB-C16	Ammeter	Number of UTE sockets	Number of IEC C13 sockets		Number of IEC C19 sockets	Number of IEC 60309 sockets
19" 1U	LZ-321	431	x				6		WZ-LZ32-10-00-000
19" 2U	LZ-322	431						4	WZ-LZ32-20-00-000
vertical 0U	LZ-323	1205	x			20	4		WZ-LZ32-30-00-000
	LZ-324	732	x		12				WZ-LZ32-40-00-000
	LZ-325	861	x			16			WZ-LZ32-50-00-000
	LZ-326	990	x	x		12	4		WZ-LZ32-60-00-000

Type of sockets							
Standard sockets				Sockets on request			
UTE (French type) 230 V, 16 A	IEC 60320 C13 230 V, 10 A	IEC 60320 C19 230 V, 16 A	IEC 60309 230 V, 32 A	Schuko 230 V, 16 A	IEC 60320 C13 230 V, 10 A with lock	IEC 60320 C13 230 V, 10 A with fuse	IEC 60320 C13, 230 V, 10 A with fuse and check lamp

Cable plug
IEC 60309 230 V, 32 A

POWER SUPPLY SYSTEMS

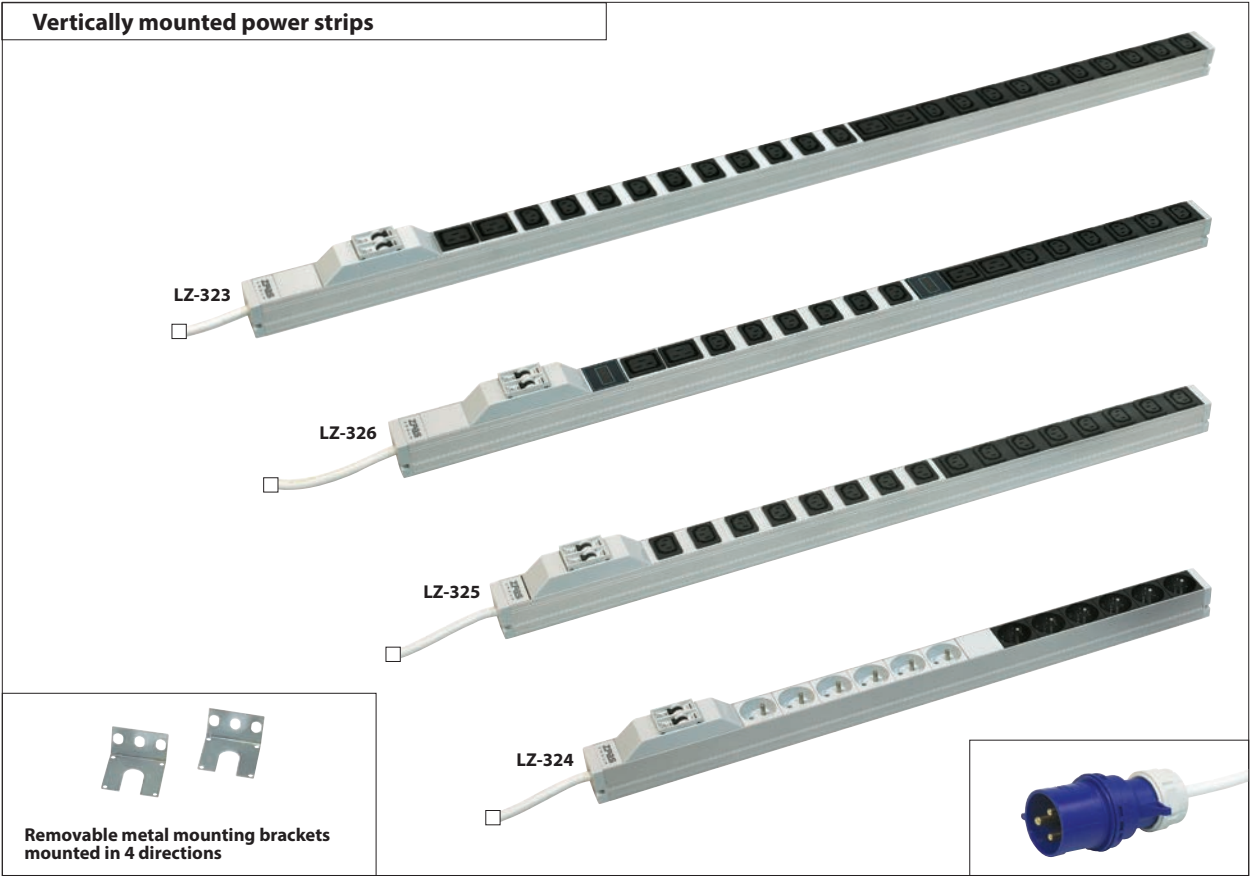
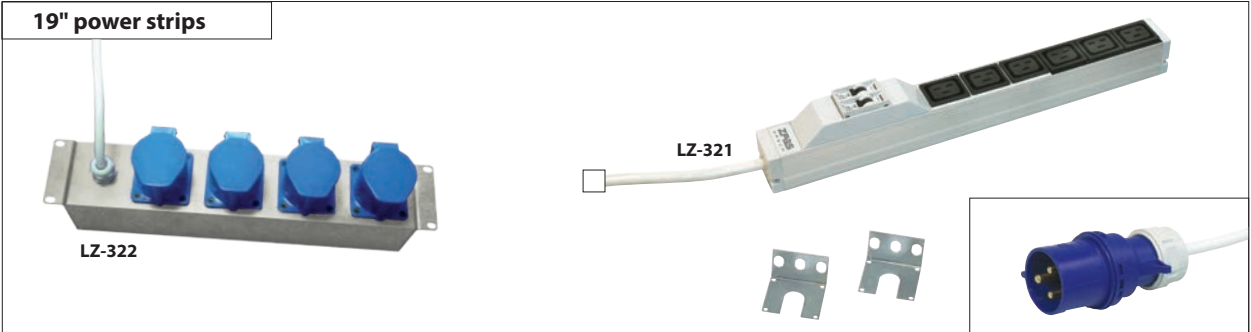

POWER SUPPLY SYSTEMS



Three-phase power strips 3 x 16 A

Characteristics

Anodized aluminium body, in natural colour.
 Plastic elements: light-grey (similar to RAL 7035), black (similar to RAL 9005) and red (similar to RAL 3002).
 Dimensions: width 44 mm, depth 44 mm, length according to the table.
 Removable metal mounting brackets for installing the strip in four directions, at 90° turning.



TECHNICAL DATA



Nominal phase voltage 230 V AC
 Maximum load 3 x 16 A / 11040 W
 Protection degree IP 20
 Supply cable 3 m, white, conductor section 2.5 mm²
 (other lengths within 2-5 m scope, available on request)

SCOPE OF DELIVERY

Power strip with brackets, set of fixing accessories.
 Note: For installation in vertical position additional elements needed, must be ordered separately - see pages 96-97.

Installation	Power strip type	Length without mounting brackets [mm]	Features				Catalogue number
			Ammeter	Number of UTE sockets	Number of IEC C13 sockets	Number of IEC C19 sockets	
vertical OU	LZ-3161	1398			36	6	WZ-LZ31-61-00-000
	LZ-3162	990		18			WZ-LZ31-62-00-000
	LZ-3163	861			12	6	WZ-LZ31-63-00-000
	LZ-3164	1076	x	18			WZ-LZ31-64-00-000

Type of sockets						
Standard sockets			Sockets on request			
UTE (French type) 230 V, 16 A	IEC 60320 C13 230 V, 10 A	IEC 60320 C19 230 V, 16 A	Schuko 230 V, 16 A	IEC 60320 C13 230 V, 10 A with lock	IEC 60320 C13 230 V, 10 A with fuse	IEC 60320 C13, 230 V, 10 A with fuse and check lamp

Cable plug
IEC 60309 3 x 16 A

POWER SUPPLY SYSTEMS

Vertically mounted power strips

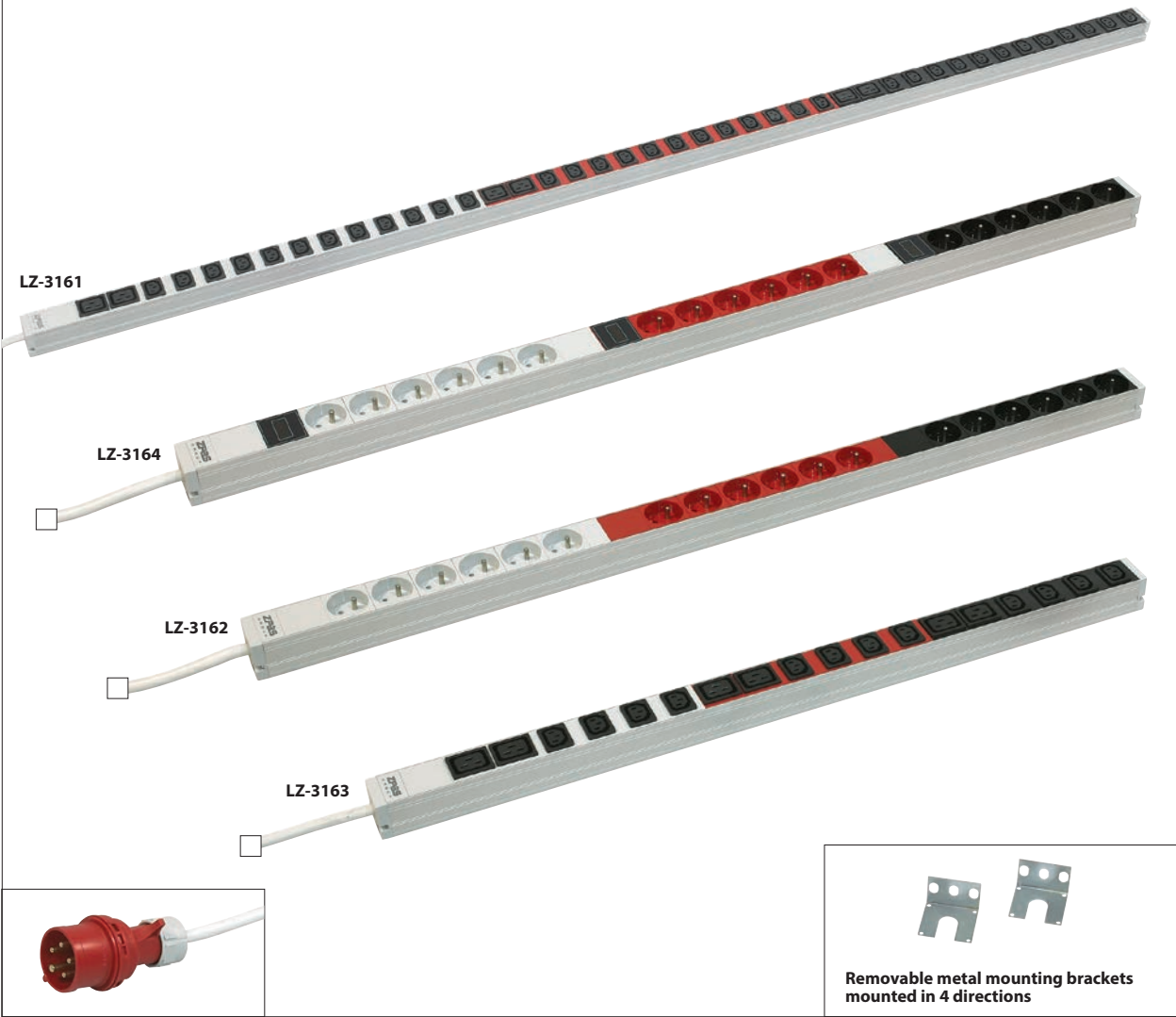

POWER SUPPLY SYSTEMS



Three-phase power strips 3 x 32 A

Characteristics

Anodized aluminium body, in natural colour.
 Plastic elements: light-grey (similar to RAL 7035) or black (similar to RAL 9005).
 Dimensions: width 44 mm, depth 70 mm, length according to the table.
 Removable metal mounting brackets for installing the strip in four directions, at 90° turnings.



TECHNICAL DATA



Nominal phase voltage 230 V AC
 Maximum load 3 x 32 A / 22080 W
 Protection degree IP 20
 Supply cable 3 m, white, conductor section 4 mm²
 (other lengths within of 2-5 m scope, available on request)

SCOPE OF DELIVERY

Power strip with brackets, set of fixing accessories.
 Note: For installation in vertical position additional elements needed, must be ordered separately - see pages 96-97.

Installation	Power strip type	Length without mounting brackets [mm]	Features					Catalogue number
			Circuit breaker MCB-C16	Ammeter	Number of UTE sockets	Number of IEC C13 sockets	Number of IEC C19 sockets	
vertical OU	LZ-3321	1097	x			6	6	WZ-LZ33-21-00-000
	LZ-3322	1355	x			18	6	WZ-LZ33-22-00-000
	LZ-3323	1590	x		24			WZ-LZ33-23-00-000
	LZ-3324	1613	x	x		18	6	WZ-LZ33-24-00-000

Type of sockets						
Standard sockets			Sockets on request			
UTE (French type) 230 V, 16 A	IEC 60320 C13 230 V, 10 A	IEC 60320 C19 230 V, 16 A	Schuko 230 V, 16 A	IEC 60320 C13 230 V, 10 A with lock	IEC 60320 C13 230 V, 10 A with fuse	IEC 60320 C13, 230 V, 10 A with fuse and check lamp

Cable plug
IEC 60309 3 x 32 A

POWER SUPPLY SYSTEMS

Vertically mounted power strips



LZ-3321



LZ-3322



LZ-3323

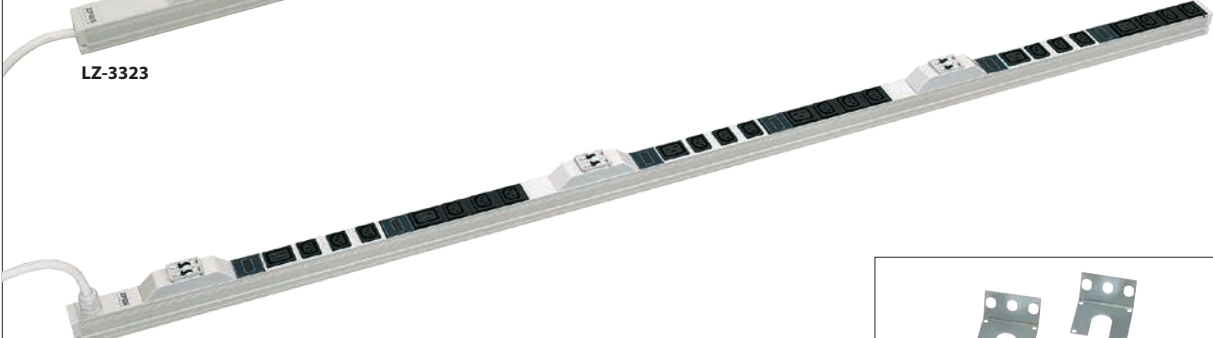

LZ-3324

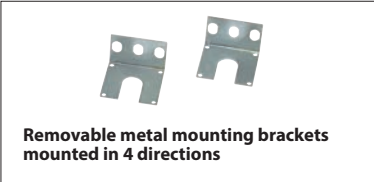

Removable metal mounting brackets mounted in 4 directions

POWER SUPPLY SYSTEMS



Monitored power strips

Anodized aluminium body, in natural colour.
 Plastic elements: light-grey (similar to RAL 7035), black (similar to RAL 9005) and red (similar to RAL 3002).
 Strip compact size: height/width 44 mm, depth 44 mm (some pieces of equipment can locally increase depth up to 70 mm), length as in the table.
 Removable metal mounting brackets.
 Strip can be installed in 4 planes.
 Built-in web server with strip current load monitoring with the Watchdog over IP function.



TECHNICAL DATA

Nominal voltage 230 V AC
 Maximum load as in the table below
 Network interface Ethernet RJ45 (10/1000 BaseT)
 Protocols TCP/IP, HTTP, SNMP, SMTP, Syslog, DHCP
 Protection degree IP 20
 Supply cable 3 m (other lengths within of 2-5 m scope, available on request), white or black, conductor section: 1,5 mm² (16 A strips), 2,5 mm² (3 x 16 A strips) or 4 mm² (32 A and 3 x 32 A strips)



SCOPE OF DELIVERY

Power strip with brackets, set of fixing accessories.

Note: For installation in vertical position additional elements needed, must be ordered separately - see pages 96-97.



Maximum load	Installation	Power strip type	Lenght without mounting brackets [mm]	Features					Catalogue number
				Circuit breaker MCB-C16	Ammeter	Number of UTE sockets	Number of IEC C13 sockets	Number of IEC C19 sockets	
16 A 3680 W	19"	LZM-161	430		1	5			WZ-LZM1-61-00-000
		LZM-162	430		1		6		WZ-LZM1-62-00-000
	vertical OU	LZM-163	732		1	12			WZ-LZM1-63-00-000
		LZM-164	1248		1		24		WZ-LZM1-64-00-000
		LZM-165	1248		1		18	6	WZ-LZM1-65-00-000
32 A 7360 W	vertical OU	LZM-321	1248	x	2	18			WZ-LZM3-21-00-000
		LZM-322	1076	x	2		12	4	WZ-LZM3-22-00-000
		LZM-323	1076	x	2		16		WZ-LZM3-23-00-000
		LZM-324	1420	x	2		24		WZ-LZM3-24-00-000
		LZM-325	1420	x	2		18	6	WZ-LZM3-25-00-000
3 x 16 A 11040 W	vertical OU	LZM-3161	1463		3	24			WZ-LZM3-16-10-000
		LZM-3162	1377		3		24		WZ-LZM3-16-20-000
		LZM-3163	1635		3		24	6	WZ-LZM3-16-30-000
3 x 32 A 22080 W	vertical OU	LZM-3321	1936	x	6	18			WZ-LZM3-32-10-000
		LZM-3322	1226	x	6			6	WZ-LZM3-32-20-000
		LZM-3323	1742	x	6		24		WZ-LZM3-32-30-000
		LZM-3324	1742	x	6		18	6	WZ-LZM3-32-40-000

Type of sockets						
Standard sockets			Sockets on request			
UTE (French type) 230 V, 16 A	IEC 60320 C13 230 V, 10 A	IEC 60320 C19 230 V, 16 A	Schuko 230 V, 16 A	IEC 60320 C13 230 V, 10 A with lock	IEC 60320 C13 230 V, 10 A with fuse	IEC 60320 C13, 230 V, 10 A with fuse and check lamp

POWER SUPPLY SYSTEMS

19" power strips

LZM-161 LZM-162

Removable metal mounting brackets mounted in 4 directions

Vertically mounted power strips

LZM-323 LZM-322 LZM-165 LZM-164 LZM-325 LZM-322 LZM-3162 LZM-3161 LZM-321 LZM-3163 LZM-3321 LZM-324 LZM-3324 LZM-3323 LZM-163

Removable metal mounting brackets mounted in 4 directions

Type of plugs			
16 A	32 A	3 x 16 A	3 x 32 A
Angle Unischuko (other plugs - see page 87)	IEC 60309 single-phase	IEC 60309 three-phase	IEC 60309 three-phase

POWER SUPPLY SYSTEMS

ACCESSORIES FOR VERTICAL INSTALLATION OF POWER STRIPS

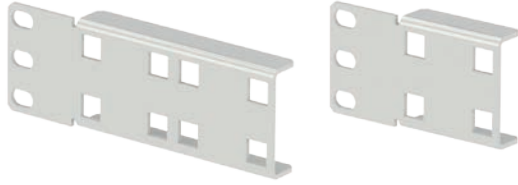

Short and long LZ bracket



Open rack with power strips installed to LZ brackets

LZ brackets

Brackets for vertical installation of power strips in data open racks.
Available in short version for 1 power strip and long for 2 power strips.

Material

Sheet steel powder painted in light grey (RAL 7035) or black (RAL 9005).

Scope of delivery

LZ bracket with fixing accessories.

LZ bracket version	Catalogue number	
	RAL 7035	RAL 9005
short	WZ-5367-53-01-011	WZ-5367-53-01-161
long	WZ-5367-53-02-011	WZ-5367-53-02-161

Package: 1 pc.

POWER SUPPLY SYSTEMS

ACCESSORIES FOR VERTICAL INSTALLATION OF POWER STRIPS

LZ fixing profile

Fixing profile for vertical installation of power strips in 800 mm wide **SZBIT** cabinets.

Material

Sheet steel powder painted in light grey (RAL 7035) or black (RAL 9005).

Scope of delivery

LZ fixing profile with fixing accessories.



For cabinet height	Catalogue number	
	RAL 7035	RAL 9005
47U	WZ-5367-52-01-011	WZ-5367-52-01-161
45U	WZ-5367-52-02-011	WZ-5367-52-02-161
42U	WZ-5367-52-03-011	WZ-5367-52-03-161

Package: 1 pc.



Server cabinet with power strips installed to fixing profiles



LZ fixing profile

POWER SUPPLY SYSTEMS



MPSM-S1 Microprocessor Power Control Panel

The most important factors that determine the correct operation of modern automation, electronics, industrial computers and other devices are the correct power supply and the appropriate climatic conditions. These are necessary to ensure ongoing operation of priority infrastructure equipment – server room, data communication, power engineering.

MPSM-S1 is a programmable 19" panel for power supply, control, monitoring and recording. It provides voltage, power and current measurement for each socket, and also temperature and humidity measurement. The device is equipped with an unparalleled set of features that make it indispensable in data communication infrastructure. Also, MPSM-S1 is equipped with a 8 GB internal memory used for storing the measurement results, events, alarms which lasts for about 24 months of continuous recording.

USABLE FEATURES

- **SOFT-START – soft start of servers, cabinets, automation components, etc.**
Allows for defining individual power-up delays for individual panel sockets after power supply recovery or after activation of the SLAVE sockets. This allows you to set a dedicated power-up scenario for the entire set of devices powered from the MPSM-S1 panel.
- **MASTER-SLAVE – energy conservation**
Automatic shut-off of SLAVE sockets (devices) when the MASTER device (socket) is powered down. The level of energy consumption for the MASTER socket is constantly monitored by the power supply panel and when it exceeds the user-defined threshold, the SLAVE sockets are re-powered up. Powering up and down has also user-defined time delay. Each socket in MPSM-S1 panel can work in MASTER, SLAVE or NONE mode (excluding MASTER-SLAVE functionality). With this solution, you can change the configuration of the set powered from the MPSM-S1 panel without having to physically plug the devices to dedicated sockets (continuity of operation).
- **PDU-THERMOSTAT – multi-stage control of fans, heaters and air conditioners**
Each panel socket can be activated by the temperature on the basis of being above or below the user-defined value. Individual socket can also be activated by a signal below or above different set temperatures.
- **PDU-HYGROSTAT – multi-stage control of humidifiers and air dryers**
Each panel socket can be activated by humidity levels on the basis of being above or below the user-defined value. Individual socket can also be activated by a signal below or above set values.

- **Output control**
Allows for powering down any panel socket regardless of its mode and time.
- **Indication of alarm states:**
 - exceeded set value for current or underload of individual sockets
 - exceeded set value for current or underload of the entire set of connected receivers
 - grid voltage above or below the setpoints
 - ambient temperature above or below the setpoints
 - humidity above or below the setpoints
- **Device settings:**
 - hysteresis (ΔT) for thermostat
 - hysteresis (ΔH) for hygostat
 - time delay for the MASTER-SLAVE function
 - load display mode power (VA) or current (A)
 - reset to factory defaults
- **On-line monitoring of:**
 - current and power for individual slots
 - current and overall joined power
 - mains voltage
 - temperature and humidity
- **Internal database for:**
 - recording of measurements, events, alarms
 - clock, calendar with battery backup
 - even 24 months of continuous recording
- **Ethernet Interface:**
 - data read and write via network (LAN/WAN)
 - remote on-line management and monitoring
 - SNMP, SNTIP, DHCP
 - Windows® management application
- **Display settings**
Choosable content of display.

Thanks to the special technique used for creating the device software, all functions are executed in parallel. It means that while we're in menu editing settings, the device is working in the background, performing its status tasks and immediately responds to changes which have just be done or received measurements. After a power loss, the device will remember the last saved configuration. The clock and the calendar work even during prolonged power failure.

POWER SUPPLY SYSTEMS

MPSM-S1 MICROPROCESSOR POWER CONTROL PANEL

SCOPE OF DELIVERY

Product name	Package	Catalogue number
MPSM-S1 Microprocessor Power Control Panel		
Accessories supplied with the panel: power supply cable, temperature and humidity sensor with 1.8 m cable, two brackets for mounting the panel in a 19" cabinet along with fixtures (screws, washers, cage nuts), four rubber feet, cable management tray with a complete set of cable clips and fasteners, software with operating manual on a CD.	1 set	WZ-4994-01-00-161
Temperature and humidity sensor with 1.8 m cable (spare part)	1 pc.	T1Z-01-0045

TECHNICAL SPECIFICATIONS

Power input	Supply voltage	85-260 V AC
	Power consumption	30 W
	Frequency	50 Hz
	Maximum overall sockets current	16 A
Power output	Output voltage	85-260 V AC (supply voltage dependent)
	Maximum current for a single socket	10 A
Protections	Current	i(max) = 20 A continuous for 150 % i(max) shut-down in 1 h, for 200 % i(max) shut-down in 5–25 sec. for 300 % i(max) shut-down in 1.6–4.8 sec., parameters for the working temperature of 25 °C
Measurements	Voltage	Measuring range: 85-260 V AC Class: 2.5% (for sine waves) Resolution: 1 V Frequency of measurements: 1/sec.
	Socket currents 1-8	Measuring range: 0-16 A (sum), 0-10 A (socket) Resolution: 0.01 A Class: 5 % (for sine waves) ± 100 mA Frequency of measurements: series of 8 measurements/sec.
	Temperature	Measuring range: 0–85 °C Measuring error: typical ± 0.3 °C Resolution: 0.1 °C Frequency of measurements: 1/sec.
	Humidity	Measuring range: 0-100 %RH Measuring error: typical ±2 % RH Resolution: 0.1 % RH Frequency of measurements: 1/sec.
	Frequency of measurements	One series of measurements/sec. (11 measurements/sec.)
Working conditions	Working temperatures	5-45 °C
	Working humidity	10-85 % (no condensation)
Casing	Dimensions	19" x 1U x 190 mm
	Weight	2.5 kg
	Protection class	IP 20

Note:

Due to the continuous construction development and changes of technical requirements, ZPAS S.A. reserves the right to change these parameters.

SOFTWARE FEATURES

In the era of globalization, data communication devices and people who manage them are often miles apart, while the devices themselves are scattered over great areas, creating locally smaller and larger systems. To make remote managing of data communication infrastructure with MPSM-S1 devices as convenient as possible, we created Windows-dedicated software. Using a built-in address book, the software connects to a specific MPSM-S1 device to perform configuration, retrieve and save data. This way, you can manage and control large systems from a single location. The application consists of tabs containing all the functions of the MPSM-S1. The first tab – DASHBOARD – is the instrument panel which contains the key parameters measured by the device. The panels include also the ARCHIVE tab with filters that you can use to download and view historical data, such as measurements, events, alarms, configuration changes.



You can generate as many windows with historical data as you want so you can compare the data in various configurations based on selected filters. Data can also be exported to a CSV file and then imported into Excel, for example. The application has a "back to the past" feature where you can select any point on the archives diagram to go back to that moment in time to see measurements, events, alarms and configuration. The data will be presented in the main application as if they were happening right at this moment. MPSM-S1 supports SNMP protocol in read mode. The software comes with an SNMP tree model as a MIB file which can be imported into your control systems. The device also supports TRAP, meaning it sends alarm and event notifications to predefined servers. Codes and descriptions of TRAPS are included with the software.

POWER SUPPLY SYSTEMS

MPSM-S1 MICROPROCESSOR POWER CONTROL PANEL

APPLICATION SCENARIO

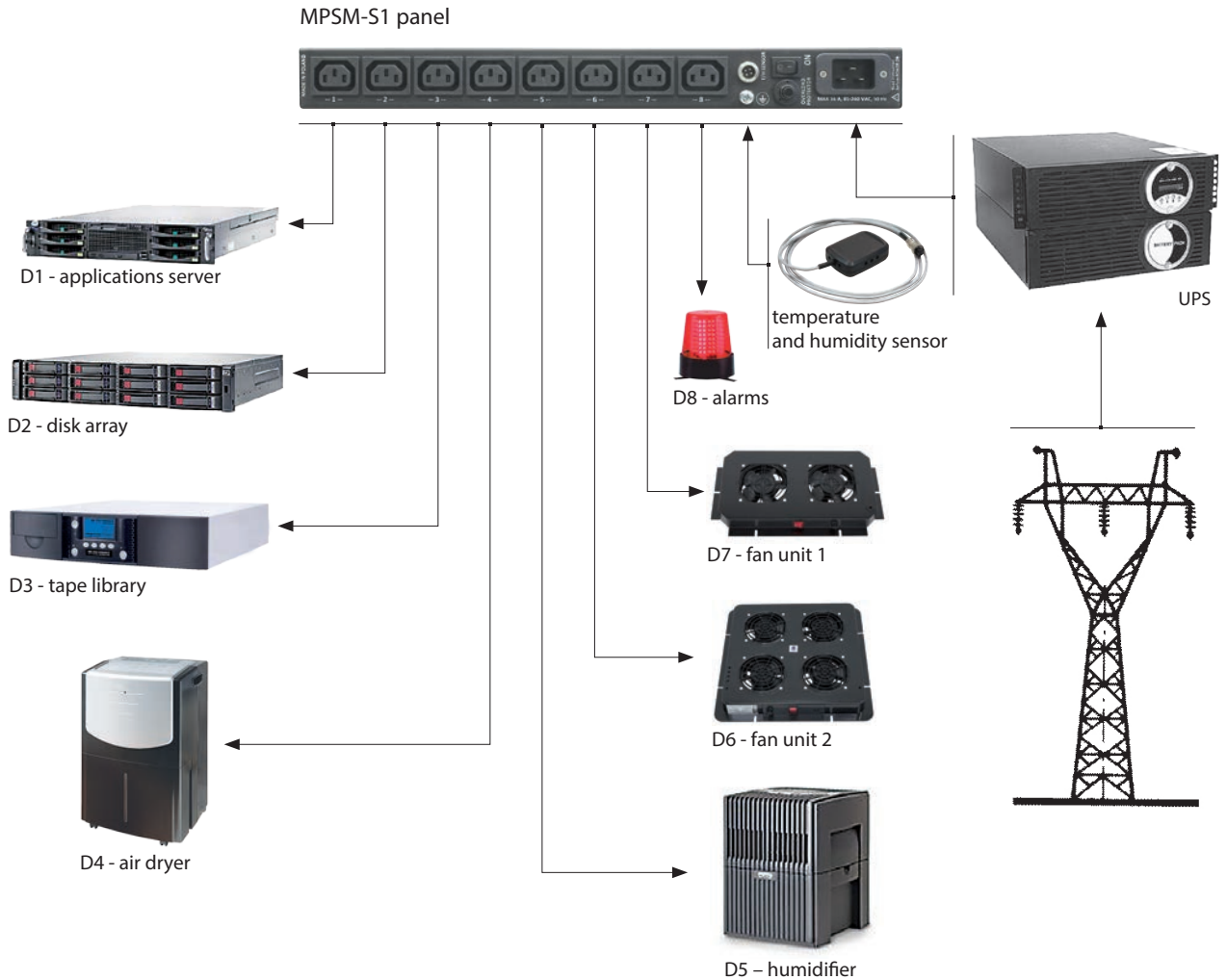

Example of programming the panel functions:

SOFT-START

Scenario for starting the devices after power supply recovery:

Time	Action
0 s	Power start
2 s	D6
4 s	D7
6 s	D8
8 s	D4
10 s	D5
12 s	D3
14 s	D2
90 s	D1

MASTER-SLAVE

Scenario for powering up Slave devices after powering up the Master device:
 D1 - Master
 D2, D3, D4 - Slave
 T = 5 s (delay time for powering down and up the Slave devices)
 I = 0,5 A (current drawn from the Master slot; below this value, the Master device is regarded as powered-down)

THERMOSTAT/ HYGROSTAT

Scenario for powering up cooling, humidifying and drying devices in the case of exceeding programmed temperature and humidity thresholds:
 D4: RH_{max} = 80 %
 D5: RH_{min} = 20 %
 D6: t_{max} = 25 °C
 D7: t_{max} = 27 °C
 D8: t_{max} = 32 °C
 RH_{min} = 15 %

INTERNAL ALARMS

Load alarms
 D1: I_{min} = 0,1 A
 Temperature alarms
 T_{max} = 35°C
 Voltage alarms
 U_{max} = 250 V
 U_{min} = 207 V
 If the current, temperature or voltage values are outside preset thresholds, the internal panel alarm will be signalled (sound signal and a flashing message on the display).

POWER SUPPLY SYSTEMS

MPSM-S1 MICROPROCESSOR POWER CONTROL PANEL

SCENARIO DESCRIPTION

The MPSM-S1 device supports the cabinet holding set of devices operating within one logical solution, UPS, main ventilation panel, auxiliary ventilation panel, humidifier, air dryer and alarms. The logical solution should be understood as a set of interdependent devices, each of which is necessary for proper operation of the whole. In such a case, the appropriate set power-up scenario is extremely important. For example, when the server is turned on faster than the disk array, then it will not detect the disk array at the time of checking the readiness of individual devices and thus the entire system may fail to start. In this scenario, the server is switched on as the last the device with an additional time delay. Then you can be sure that all of its peripherals (disk array, tape library, etc.) are ready to work and will return ready-to-use during data bus scanning. Furthermore, when the main device of the system is turned off, the other devices do not have to be working any longer.



In this configuration, the MPSM-S1 ensures the following:

- correct scenario for powering up the devices
- a device dependent on the master server is disconnected after the DeltaMS time, when the server is remotely or physically switched off
- maintaining constant temperature by controlling the ventilation panel, and in the next step, when the temperature continues to rise, powering up the auxiliary ventilation panel
- maintaining constant humidity in a room by switching the humidifier on when RH humidity drops below 20 %, and switching the air dryer on when RH humidity rises above 80 %
- MPS M-S1 alarm and external alarm (alarm lamp) when the MPS M-S1 have exhausted all measures and is no longer able to maintain the correct ambient temperature or humidity
- MPSM-S1 alarm when the server is disconnected or shuts down by itself due to a failure or other actions
- supply voltage level control and MPSM-S1 alarm when the value of this voltage exceeds the allowable limits
- on-line visualization of temperature, humidity, supply voltage or currents on each of the slots, and their overall values from all slots; all on the LC D display

Note:

The parameter values used in the scenario are merely illustrative and may vary from those in specific real systems.

MONITORING AND CONTROL SYSTEM BASED ON MPSM-S1 DEVICES

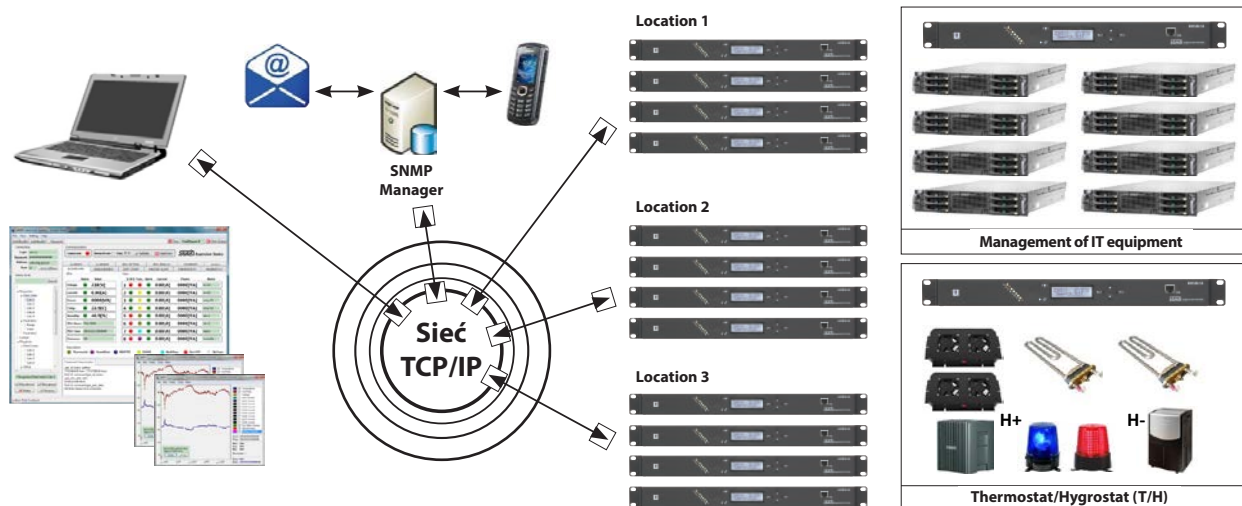

POWER SUPPLY SYSTEMS

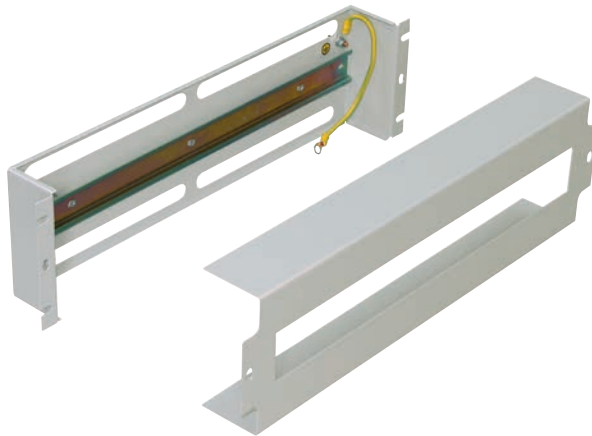

Voltage distribution panel

Voltage distribution panel

Universal 19" enclosure for modular devices. In the standard version equipped with DIN rail and housing with 402.5 x 45.5 mm opening.

Dimensions

- height:..... 133 mm (3 U),
- width:..... 19" (internal width: 446 mm),
- depth: 60 mm

Capacity of panel - maximum number of built-in S-type modules (width of module 17.5 mm): 22 pcs.

Material

Sheet steel textured powder painted in light grey (RAL 7035) or black (RAL 9005).

Scope of delivery

- In the standard version, panels are sold as empty enclosures, complete with:
- mounting base,
 - DIN rail,
 - housing,
 - fixing accessories.

Package	Colour	Catalogue number
1 pc.	RAL 7035	WZ-PS3U-00-00-011
	RAL 9005	WZ-PS3U-00-00-161

Voltage distribution panels equipped with electrical equipment

On special request, the PS-3U panel can be equipped with electrical equipment according to the customer's specification.

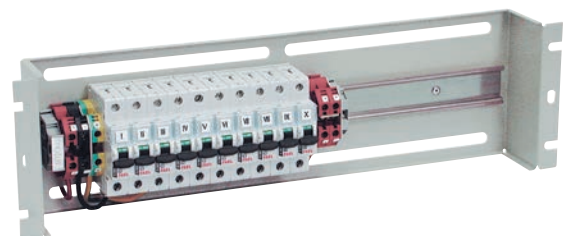
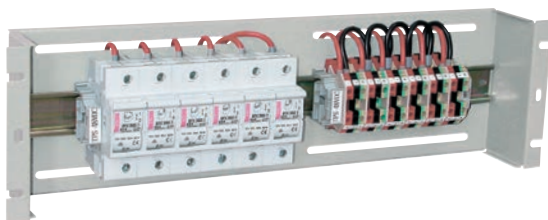

Sample PS-3U panels with electrical equipment