

## The Complete KNUTH Portfolio



### The 2022 CNC Portfolio:



Premium Line Machining Centers powered by Heidenhain or SIEMENS: **Vector 1000M**



Powerful, productive and cost-effective: **Roturn 400**



Fully automated with manual cutting angle adjustment: **ABS H NC**

## Conventional Machining 4.0

Advanced drives, smart functions, increased productivity

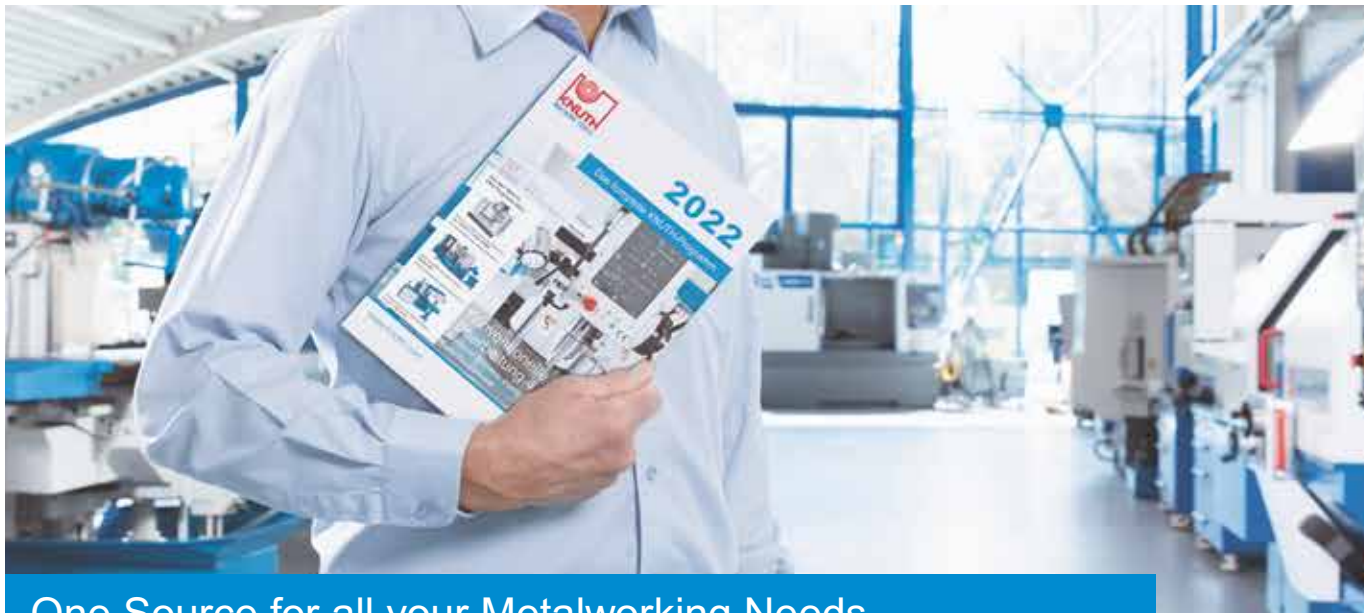

## One Source for all your Metalworking Needs

At our headquarters in Wasbek, Germany, you will find the right machines and tools for all your metalworking needs. We keep more than 900 machines in stock, and many of these machines are ready for demos.

**Request expert consultation!** Our experienced sales consultants combine their technical expertise and in-depth industry

knowledge to help you find the perfect machine and financing option for your business.

More than 1400 machines are shipped annually from our headquarters in Wasbek, Germany. Every machine has to pass a series of comprehensive tests.

Our Quality Management System is **ISO 9001** certified and continuously reviewed and improved.



### Service without compromises

## We make sure that your production process runs smoothly

Our expert services will help you get the full potential of your machines. From installation to maintenance, repairs and upgrades - our highly qualified technicians will take care of ev-

erything quickly and professionally. Our well stocked warehouse at Wasbek and a global supplier network ensure prompt availability of replacement parts and consumables.

- Installation - Commissioning - Training
- Inspection and Maintenance

- Operation and Maintenance Training
- Service and Spare Parts

For complete information on our extensive service packages, see pages 302 and 303



www.knuth.com

## FOR THE BEST DECISIONS



Dear Customers:

We look forward to the beginning of each new year and the introduction of our new product line-up.

**CNC Technology:** Both the Numturn lathes and the CNC press brakes are now equipped with powerful controls. Our FlexLoader is suited perfectly for a pragmatic, cost-efficient entry into automated production. It features a simple loading system with a universal robot for lathes or milling machines, and is made in Germany. The "E.T. Box" is a compact electronic remote maintenance system and a useful add-on for any CNC machine. This module establishes a secure VPN connection between your machine and our technicians, so we can easily and quickly assist you in case of technical questions or failures.

**Service:** We continuously develop and advance our service offers. With our transparent and cost-efficient service packages you can protect your investment for the long term and keep your operating costs low. We also invested in a larger service team and in more effective software solutions, so we can guarantee maximum customer satisfaction.

**Cutting Technology:** The ACE Laser is one of KNUTH's best success stories. This fiber laser features up to 6 kW power, a shuttle table and tube cutter that has convinced many customers over the last few years. The new ACE Laser Compact R completes this line and offers all the advantages of the most advanced fiber laser technology in a small package.

**Conventional Machines:** Due to continuous innovation, some of the KNUTH machines have evolved to true classics over the years. For example, classic band saws and drill presses deliver much higher precision due to servo motors in their feeds. VT series drill presses can now be controlled intuitively via touchscreens featuring a selection of various smart functions. The Basic 170 Super PRO bench lathe is a new version of our PRO series and features an improved ergonomic design and an integrated cooling system.

We look forward to 2022 being an even more productive year.

Karsten Knuth  
Philip Knuth  
Kristian Knuth

### Reliable Source of Information

As our products become more powerful and complex, decision makers need reliable, clear data and sources of information. Our new website is our response to meet this growing demand for information.

- ✓ Overview of the complete KNUTH Machine Tool Program
- ✓ Complete Information at a Glance
- ✓ Up-to-Date News
- ✓ Additional Decision-Making Aids (Downloads, Videos)
- ✓ Clearly Structured Navigation



www.knuth.com

# Contents



## ELECTRIC DISCHARGE MACHINING

- Wire EDM 6 - 7
- Sinker EDM 8 - 9



## CNC MACHINING

- CNC Lathe 12 - 35
- Stahlwerk Premium 24 - 29, 56 - 61
- CNC Drill Press / Milling Center 38 - 45
- CNC Milling Machine 48 - 67
- Training Center 68 - 71
- Automation / Digitalization 74 - 77



## TURNING

- Vertical / Box-Way Lathes 80 - 83
- Heavy-Duty Lathe 84 - 87
- Servo-Conventional 88 - 89
- Universal / Precision Bench Lathes 90 - 105



## MILLING

- Servo-Conventional 108 - 113
- Tool Milling Machine 114 - 115
- Bed-Type Milling Machine 116 - 119
- Universal / Multi-Purpose Milling Machines 120 - 131
- Drill Press / Milling Machine 132 - 133



## DRILLING

- Drill Press / Milling Unit 136 - 137
- Radial Drill Press 138 - 146
- Rapid Radial Drill Press 147 - 149
- Box-Column drill presses 150
- Column / Bench Drill Presses 151 - 157



## SAWING

- Fully Automatic Band Saw 160 - 177
- Semi-Automatic Band Saw 180 - 181
- Horizontal Band Saw 178 - 179, 184 - 185
- Miter Band Saw 186
- Roller Conveyor 187
- Vertical Band Saw / Circular Cold Saw 188 / 189



## GRINDING

---

■ Cylindrical Grinding Machines	192 - 195
■ Surface Grinder	196 - 203
■ Universal Grinding Machines	204 - 205
■ Grinders	206 - 211



## CUTTING SYSTEMS

---

■ Laser	214 - 221
■ Plasma	222 - 231
■ Waterjet	232 - 235

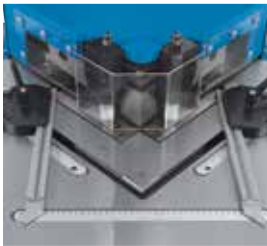

## SHEARS/CUTTERS

---

■ Swing-Beam Shears	240 - 247, 251
■ Ironworkers	248 - 249
■ Notching Machines	250



## BENDING AND FORMING

---

■ Press Brakes	256 - 259
■ Folding Machines	260 - 262, 251
■ Roll Benders	263 - 267
■ Ring and Profile Bender	268 - 269



## PRESSING

---

■ Hydraulic Presses	272 - 273
■ C-Frame Presses	274 - 275
■ Workshop Presses	276 - 279
■ Straightening and Die Presses	280 - 281



## WORKSHOP EQUIPMENT

---

■ Workshop Equipment and Machine Accessories	284 - 290, 301
■ Clamping Systems and Accessories	291 - 298
■ Measuring Tools	299

## A Perfect Cut

Continental Engineering Services rely on high speed wire EDM by KNUTH for their 3D-printed production.



### Exact Cuts Even in Very Hard Material

“At our Technology Center, we have access to state-of-the-art manufacturing processes and can execute many different process steps in a relatively small space. This will benefit the customer in regards to quality, flexibility, and speed,” said Markus Schnell from Product Solutions at CES. Schnell works in Additive Design and Manufacturing (ADaM). They employ additive production, also called 3D-printing, to produce pipes, brake calipers, holders or frames attached to a metal plate, where the metal plate subsequently will have to be separated from the component. As an alternative to the saw that was initially utilized, the manufacturing specialists were looking for a wire electric discharge machine (EDM) that could produce smooth cut surfaces and also quickly cut very hard materials like aluminum and stainless steel. A first look at the market indicated that CES would have to make a considerable investment to find a solution for this relatively minor task.

Continental Engineering Services has nothing to do with automotive tires. CES is a wholly owned subsidiary of Continental and generates most of its sales from development services for automotive and industrial applications. In the specialty fields of automotive interiors, drivetrains and chassis applications, CES develops new solutions for technologically challenging tasks and also adapts large series productions, so customers can fulfill their special requirements. Their operation is focused on driver assistance systems, automotive electronics, electrical drive systems, and control systems for conventional drives. CES has 1.500 employees – mostly engineers and technicians – at their German headquarters in Frankfurt/Main and other sites in Europe, Asia, and America. The secret to this success lies in the transfer of automotive expertise in a wide variety of applications and industries, including consultation, development plus manufacturing possibilities, including prototype and small batch production at their close-by Continental production site in Karben, Germany.

### NeoSpark Cuts Solid Metal Plates up to 1.200 x 700 mm

“But then we found the KNUTH NeoSpark 500. Contrary to similar products, it could be used for many different materials and came with an unbeatable price-performance-ratio,” Schnell remembered. In 3D printing, it often is necessary



## High Speed Wire EDM NeoSpark 500

- High precision and quality plus excellent price/performance ratio
- Workpiece length × width × thickness (max.) 1.300 × 800 × 500 mm

### Cutting Technology for 3D Metal Printing High Speed Wire EDM

- Virtually no pressure on the component
- Delicate structures can be machined without the risk of deformation or microcracking in the cut surface
- Perfect balance between cutting accuracy and high cutting speed
- Significantly more cost-efficient than conventional wire EDM
- Long wire life = high productivity and minimal downtime

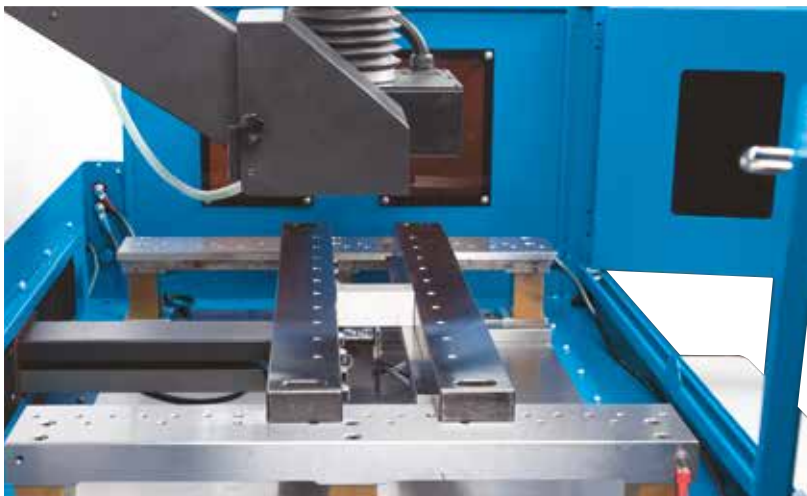

The NeoSpark 500 cuts even high-alloyed tool steel with ease.



The workpiece geometry is programmed via Teach-In function to ensure a perfect division. This shows a machined construction platform made of stainless steel components.

to separate solid metal plates with diameters up to 300 mm. The NeoSpark 500 cuts workpieces with lengths up to 1.200 mm and widths up to 700 mm and uses a molybdenum wire that enables it to cut through extremely hard material with ease. One of the reasons for the superb cutting results is the use of a custom electrolyte that increases the cutting performance and ensures quick removal of the eroded material. KNUTH convinced the skeptical CES engineers with just one sample cut and received the order.

### No Rework Necessary

Schnell added: "Operator training was super as well, and it is surprisingly easy to operate. Engineers as well as our trainees can quickly become familiar with this machine." The developers use the high speed wire EDM about four hours per day and for a much wider scope than initially thought. "The cutting results are great and no rework is required," said Schnell. "Meanwhile, we also use the NeoSpark to cut finished functional parts in small batches." At CES, the news about the NeoSpark 500's great success has spread. "For our purposes, one machine is sufficient, but other departments that work in manufacturing have also shown quite some interest," revealed Schnell.

**Continental Engineering Services GmbH  
Additive Design and Manufacturing (ADaM)**  
Dieselstraße 6-20, 61184 Karben, Germany  
Phone +49 6039 981541  
adam@conti-engineering.com



NeoSpark B 500 is shown



See this machine  
in action on  
YouTube



- The NeoSpark CNC Electric Discharge Machine delivers excellent cutting performance, is cost-effective, and operating cost is extremely low
- The cast-iron machine frame features a modern C-frame with T-base, multiple reinforcing ribs, precision-machined surfaces and thermal stress-relief
- Rigid linear guides and precision preloaded ballscrews on all axes ensure permanent mechanical precision
- The IPC-based control system with servo drives is fine-tuned to the manufacturing process requirements, plus, it is user-oriented and reliable
- 2-step filtration system in the dielectric tank ensures uninterrupted operation and high machining quality



The NeoSpark allows production of delicate contours with superior surface quality





In additive production (3D-Printing) the produced complex parts are attached to a metal plate, where the metal plate subsequently will have to be separated from the component (Neospark 500 B Continental Engineering Services)

## High-Speed Wire EDM Cutting Technology for 3D Metal Printing

- Compared to mechanical divisions, there is virtually no pressure on the component
- Delicate structures can be machined without the risk of deformation or microcracking in the cut surface
- Perfect balance between cutting accuracy and high cutting speed
- Significantly more cost-efficient than conventional wire EDM
- Long wire life ensures high productivity and minimal downtimes

## Standard Equipment

erosion wire 0.18 mm, Dielectricum 10 kg, electronic manual control unit, constant wire tensioner, Draht-einrichtungshilfe, generator, USB port, Ethernet port, standard wire guides, dielectric tank with pump, work lamp, warning beacon, AC power stabler, leveling plates and jacks, central lubrication, operating tools, operator manual

Specifications		NeoSpark B 300	NeoSpark B 500
<b>Working area</b>			
Table dimensions	mm	620x440	820x535
Workpiece, length x width x thickness (max.)	mm	960x550x300	1.190x650x400
Workpiece weight (max.)	kg	500	800
X-axis travel	mm	400	600
Y axis travel	mm	300	400
Travel U / V-axis	mm	70 / 70	70 / 70
Z-axis travel	mm	250	350
Cutting angle (with guide)		± 10° / 80 mm	± 10° / 80 mm
Cutting capacity (max.)	mm <sup>2</sup> /min	200	200
Generator	A	10	10
<b>CNC control</b>			
Display size / type		15" / LED	15" / LED
Controlled axis		4	4
Input increment (min.)	mm	0,001	0,001
<b>Dielectric system</b>			
Dielectric, tank capacity	l	180	180
<b>Feed</b>			
Rapid feed X / Y axis	mm/min	1.000	1.000
<b>Accuracies</b>			
Positioning accuracy X / Y axis	mm	0,01	0,01
Positioning accuracy U/V axis	mm	0,02	0,02
Repeatability X / Y axis	mm	0,005	0,005
Repeatability U / V axis	mm	0,01	0,01
Best surface roughness	µm Ra	0,8	0,8
<b>Drive capacity</b>			
Motor rating X / Y axis	kW	0,15	0,2
Motor rating U / V axis	kW	0,02	0,02
Motor rating Z-axis	kW	0,02	0,02
Total power consumption	kVA	2	2
<b>Measures and weights</b>			
Overall dimensions (length x width x height)	m	2,04x1,6x1,83	2,4x1,89x2,06
Weight	kg	2.000	2.600
Part No.		180558	180559



ZNC 435 L is shown



Fire extinguishing system for added safety

- user-friendly CNC control assists the user in the selection of work parameters
- the machine frame design incorporates modern aspects plus many years of manufacturing experience
- X- and Y-axes are equipped with preloaded ball screws for low maintenance and high precision
- the main axis is positioned by a precision spindle, which has its own lubricant circuit - ensuring constant temperature conditions at the spindle, minimum friction and maximum precision
- the dielectric system is driven by a premium pump made by a renowned European manufacturer

- machine operation is user-oriented and easy to learn
- finely-incremented work parameters allow high powered material removal and finishing in one process
- diagnostic information is very helpful

## ZNC-EDM 250

### Economical Entry-Level Electric Discharge Technology

- NC controlled Z-axis feed
- compact design for small part machining
- rigid machine base
- Linear scales on all axes to ensure constant precision
- separate dielectric reservoir
- low-maintenance and high efficiency
- DC servo-drive for precise control and system stability
- easy-to-learn operation
- direct parameter input and adjustment at the control panel
- machining parameters for specific operations can be stored

### Standard Equipment

control unit, fire extinguishing system, work lamp, filter system, scale X- / Y-axis, chuck, operating tools, operator manual

### Options

Options	Part No.
• Planetary erosion head	250277
• Adjustable electrode holder / ZNC-EDM 250	100107
• Magnetic clamping plate	250278
• E-ZNC 760L spare part package for 100116	259217



ZNC 250 is shown

### Specifications

		ZNC-EDM 250	ZNC 435 L	ZNC 760 L
<b>Generator</b>				
Generator power consumption	kVA	3,5	7,5	9
Removal rate (max.)	mm <sup>3</sup> /min	400	500	800
Electrode wear, min.	%	≤ 0,2	≤ 0,2	≤ 0,2
Mean generator capacity	A	40	80	100
Generator weight	kg	-	200	200
Roughing depth	µm Ra	< 0,3	< 0,3	< 0,3
<b>Machine</b>				
X axis travel	mm	250	450	700
Y axis travel	mm	200	350	600
Quill stroke	mm	200	250	300
Table dimensions	mm	450x280	700x450	700x1.200
Electrode holder-to-table distance	mm	200 - 400	250 - 600	300 - 870
Electrode weight (max.)	kg	30	75	200
Workpiece weight (max.)	kg	200	700	2.000
Dimensions (length x width x height)	mm	1.390x1.480x2.100	1.500x1.600x2.100	1.855x1.650x2.550
Weight	kg	1.000	1.800	3.800
Part No.		100105	100115	100116

# CNC turning machines

**See for yourself live:** Many models are in stock or can be viewed and tried out at a user's location near you. Make a demonstration appointment! [info@knuth.com](mailto:info@knuth.com)



## Experience our machines in action!

With our YouTube channel KNUTH Machine Tools, you stay up to date with all the news and developments.



Vertical turning machine

### Verturn II VDM CNC

Swing **1.250 - 2.300 mm**  
Machining height **1.000 - 1.400 mm**

Easy handling of large workpiece  
weights up to 8 tons

Page 14 / 15



CNC flat bed turning machine

### TubeTurn CNC

Turning diameter **1.000 mm**  
Center width **3.000 mm**

Large spindle bore and  
dual lathe chuck

Page 16 / 17



Universal turning machine

## Forceturn 630 / 800 CNC

Turning diameter **670 - 818 mm**

Center width **1.500 - 5.000 mm**

Page 18 / 19



CNC cycle turning machine

## Numturn

Turning diameter **420 - 660 mm**

Turning length **1.000 - 1.970 mm**

from page 20 onwards



CNC inclined bed turning machine

## TAURUS / MERKUR / ORION

Turning diameter **190 - 690 mm**

Turning length **390 - 2.265 mm**

from page 24 onwards



Inclined bed turning machine

## Roturn 400 C / 402 C

Turning diameter **400 mm**

Workpiece length **430 mm**

Page 32 / 33



Inclined bed turning machine

## Roturn 400 GT

Turning diameter **400 mm**

Workpiece length **380 mm**

Page 34



Universal turning machine

## Rofeeder

Rod diameter **5 - 65 mm**

Rod length **280 - 1.550 mm**

(max. spindle length)

Page 35



# CNC Controls for Lathes

## Best quality and technology

KNUTH CNC machines set themselves apart with a sophisticated proven design and lasting value. We offer machines with the most advanced CNC technology - from vertical or horizontal CNC lathes to turning centers with driven tools and compact lathes for CNC training.

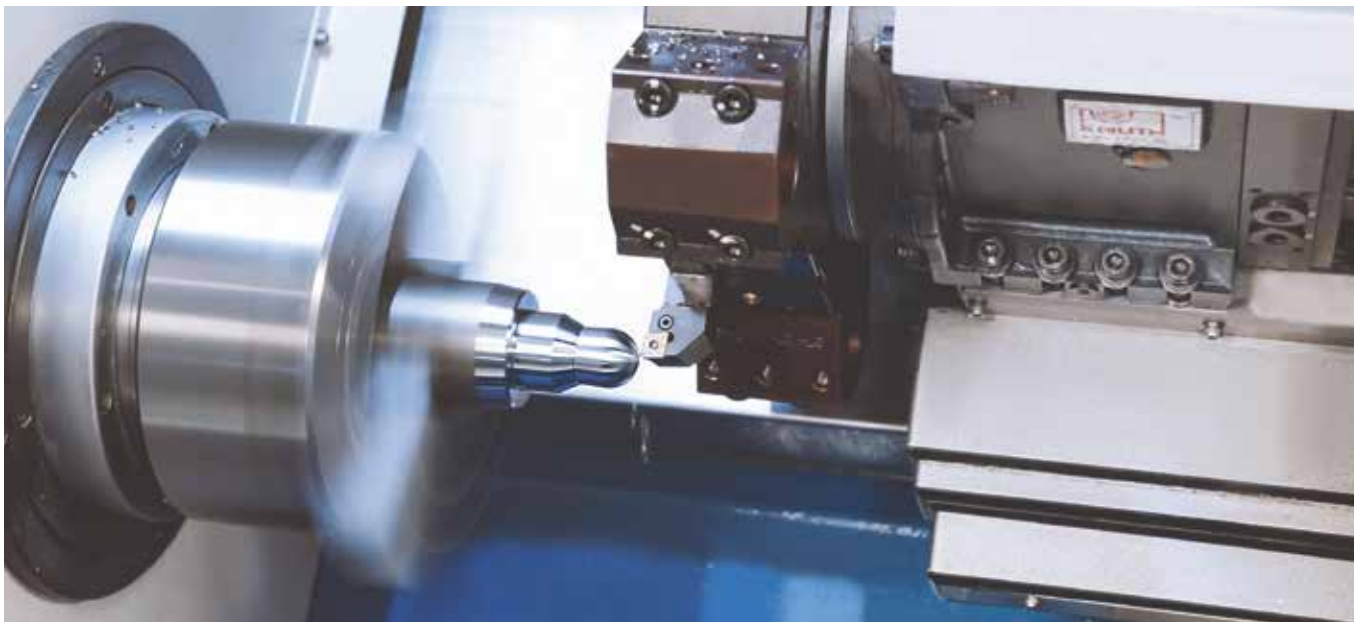

## Siemens 828D



### Increased productivity with SINUMERIK

In the field of turning and standardized machines, the SINUMERIK 828D with its unique CNC performance sets new productivity standards. With its technology-specific system software, the SINUMERIK 828D controls can be used for a much wider range of applications, including everything from box-way lathes to turning centers with driven tools and Y-axis.

- **Robust:** A front control panel made of magnesium die-cast, the panel-based CNC design with a clearly structured interface, and IP65 protection rating make the SINUMERIK 828D a reliable partner even in very harsh environments.
- **Maintenance-free:** Thanks to NV-RAM technology no fan, hard disk or backup battery are required, making the SINUMERIK 828D completely maintenance-free.
- **User-friendly:** A full QWERTY keyboard with tactile keys and a high-resolution 10.4" TFT color display ensure easy operation of the SINUMERIK 828D. USB, CF-Card and RJ45 ports are located at the front panel allowing quick and easy transfer of CNC data.

### Easier and faster from the drawing to the finished part

**ShopTurn** is an easy and efficient programming solution that is perfectly suited for CNC milling of single parts and small batches. The software allows for quick entry into CNC technology without major programming efforts or prior CNC knowledge.



# Siemens 808D Advanced TTL



## The entry-level CNC for standard machines

The SINUMERIK 808D ADVANCED adds momentum to standard lathes and milling machines. Leading CNC technology plus a revolutionary operating concept make the SINUMERIK 808D ADVANCED the perfect entry-level machine for newcomers in the world of CNC machining.

## Perfect for Instruction and Training

### SINUMERIK 808 – Perfectly pre-configured CNC system for standard machines

The SINUMERIK 808D ADVANCED is a panel-based CNC control with an excellent price/performance ratio. This compact and user-friendly entry-level solution is ideal for simple turning applications. It is easy to operate, set up and maintain, plus high reliability make this control ideal for equipping entry-level CNC machines.

Detailed programming instructions provide the fundamentals of CNC programming.



# Fanuc 0i TF



## Simple • Efficient • Intuitive

FANUC 0i has been designed for the utmost ease of use of the machine.

- Easy programming and operation, short learning curve
- User-friendly graphics display for visual verification of parts programs
- Use of existing programs without reprogramming requirements
- High-speed machining and standard nano-interpolation
- Fixed cycles and custom macro B for simplified parts programming
- State-of-the-art functionality, like jolt reduction, nano smoothing, and AI Contour Control II - compatible with previous version series 0 and series 0i models A, B, C and D
- Series 0i Model F are the successor models of the Series 0 and Series 0i, which are the most popular CNC controls worldwide with over 700,000 installations
- With up to 4 simultaneously controlled axes, the CNC Series 0i provides the best controls for highly demanding machine tools

**Manual Guide:** all created programs are converted to G-Code in the background. Thus, any program created in an easy dialog mode can be edited anytime in G-Code mode and vice versa. Programs created with G-Code can be downloaded and processed, and programs generated via Manual Guide i can be sent to other machine tools, ensuring maximum compatibility.



## Verturn II VDM CNC

Efficiency and precision for high quality, power, and reliability



See this machine  
in action on  
YouTube



- heat-treated machine bed made of premium HT250 cast-iron
- large, induction-hardened and precision-ground rectangular guides with synthetic coating ensure optimum sliding and damping properties
- high-precision preloaded ball screws from renowned manufacturers on all axes
- hydraulic clamping of cross traverse







Face plate with 4-station tool changer

## Standard Equipment

Siemens 828 D control, electronic hand-wheel, 4-jaw face plate chuck, automatic 4-station tool changer, coolant system, control cabinet with heat-exchanger, signal lamp, chip conveyor, hydraulic unit, oil cooler, working area lightening, operating tools, operator manual

## Options

## Part No.

• Coolant Concentrate 5 Ltr.	103184
• Clamped Turning Tool Set 25 mm	108670
• Indexable Insert Set 25 mm, 30 pcs.	108675
• Hydraulic measuring tripod	108810
• Power Worker Metal Cutter	123040
• E-Verturn II 1250/1600/2300VDM CNC spare part pack. for 5 years	259162

- Includes the proven Siemens 828 D SL Control
- 4-step precision gears and infinitely variable 45 kW main motor - for high torque (up to 40000 Nm) across the entire speed range
- Chip conveyor with chip carriage and automatic 4-station tool changer complete this extensive standard equipment

## Specifications Verturn II VDM

		1250 CNC	1600 CNC	2300 CNC
<b>Working area</b>				
Turning diameter, vertical	mm	1.250	1.600	2.300
Machining height (max.)	mm	1.000	1.200	1.400
X-axis travel	mm	700	915	1.180
Z-axis travel	mm	650	800	1.000
Travel Z1-axis	mm	650	850	1.050
Workpiece weight (max.)	kg	3.200	5.000	8.000
<b>Headstock</b>				
Speed range	1/min	0,5 - 250	0,5 - 200	0,5 - 100
Torque max.	Nm	23.000	37.500	52.500
Lathe chuck diameter	mm	1.000	1.400	2.000
<b>Feed</b>				
Rapid feed X- / Z-axis	mm/min	4.000	4.000	4.000
Feed W-axis	mm/min	440	440	440
<b>Tooling</b>				
Number of tool stations	Pieces	4	4	4
Tool-change time tool/tool	sec	10	10	10
Tool weight max.	kg	25	25	25
<b>Accuracies</b>				
Positioning accuracy	mm	0,03	0,03	0,03
Repeatability	mm	0,015	0,015	0,015
<b>Drive capacity</b>				
Motor rating main drive	kW	30	37	45
Motor rating feed	kW	2,2	2,2	2,2
<b>Measures and weights</b>				
Overall dimensions (length x width x height)	m	5,3x3,8x4,2	6,5x4,2x4,4	7,6x5x5,4
Weight	kg	9.500	12.000	20.000
Part No.		180675	180676	180677



- Fanuc 0i TF-V with Manual Guide 0i
- Spindle bore up to 360 mm

- This machine was designed for use in demanding petroleum industry applications and integrates decades of experience
- The wide machine bed features large, hardened and ground guideways and high rigidity
- Machining lengths up to 3.000 mm - expandable to 16.000 mm upon request
- Massive headstock with main spindle running in tapered roller bearings, and 2 lathe chuck mounts
- Spindle bore 280 and 360 mm (standard) - Up to 630 mm through-bore upon request
- Fanuc 0i TF-V with Manual Guide 0i features advanced control technology and maximum reliability
- high-torque drives and preloaded ball screws on all axes
- Automatic 2-step gears with 2 infinitely variable speed ranges



Steady rest with large capacity

- Hardened and ground gears for effective power transmission
- Powerful main drive motor with 30 kW rating
- Heavy-duty 4-station tool holder with automatic tool changing function
- Including high-performance coolant system, and central lubrication unit



4-jaw chuck, at left side

## Standard Equipment

Fanuc 0i TF-V with Manual Guide 0i, electronic hand-wheel, two 4-jaw faceplate lathe chucks 720 mm Ø (800 mm for 3630), automatic 2-step gears, 4-station tool holder, steady rest 50-470 mm, coolant system, central lubrication, mechanical tailstock, work lamp, operating tools, operating manual and programming instructions

## Options

## Part No.

• E-TubeTurn 2830 CNC spare part package for 5 years for 180630	259114
• Clamped Turning Tool Set 16/20/24 mm, 9-pc	108780
• Indexable Insert Set 16/20/24 mm, 30-pc	108782
• Coolant Concentrate 5 Ltr.	103184
• E-TubeTurn 3630 CNC spare part package for 5 years for 180631	259111

## Specifications TubeTurn CNC

**2830**

**3630**

### Working area

Turning diameter over bed	mm	1.000	1.000
Turning-Ø over support	mm	650	620
Bed width	mm	600	755
Center height	mm	500	500
Machining length (max.)	mm	3.000	3.000
X-axis travel	mm	600	610
Z-axis travel	mm	2.800	2.800

### Headstock

Speed range	1/min	5 - 450	3 - 315
Spindle bore	mm	280	360

### Feed

Rapid feed X-/Z-axis	mm/min	4000 / 6000	4000 / 6000
----------------------	--------	-------------	-------------

### Tooling

Number of tool stations	Pieces	4	4
-------------------------	--------	---	---

### Accuracies

Positioning accuracy X- / Z-axis	mm	0,03 / 0,06	0,03 / 0,06
Repeatability X- / Z-axis	mm	0,012 / 0,025	0,012 / 0,025

### Tailstock

Tailstock taper		MT 6	metric 80
Tailstock quill diameter	mm	120	160
Tailstock quill stroke	mm	250	300

### Drive capacity

Motor rating main drive	kW	18,5	30
Motor rating X- / Z-axis	kW	2,5	3
Total power consumption	kVA	35	50

### Measures and weights

Overall dimensions (length x width x height)	m	5,8x1,4x1,5	6,3x2x1,75
Weight	kg	8.000	13.000
Part No.		180630	180631



Forceturn 800.30 is shown

- Spindle bore 85 or 105 mm
- Spindle speeds up to 2250 rpm

- lots of experience went into the design and construction of this machine bed featuring large guides that are hardened, ground and counter-laminated
- Powerful main drive motor handles part weights up to 1,7 t with ease
- Infinitely variable, programmable, and adjustable spindle speeds with automatic 3-step main gear
- Fagor 8055i A-TC featuring intuitive, easy to learn cycle programming, including Profile Editor, for batch and single part production of complex workpieces
- graphical simulation for added safety
- heavy, automatic 4-station servo-driven tool changer for programmed tool changes
- 2 electronic hand-wheels at the control panel for manual operation and for easy, quick setup of new workpieces and tools
- a high-performance coolant system and automatic central lubrication system are included



Easy handling: for positioning, the tailstock can be coupled to the support



Compact control unit with electronic hand-wheels



Option: steady rests up to 400 mm diameter

## Standard Equipment

Fagor 8055i FL-TC control, 2 electronic hand-wheels, 3-jaw chuck Ø 300 mm, automatic 3-step gears, 4-station servo tool holder, coolant system, central lubrication, tailstock, work lamp, operating tools, operating manual and programming instructions

Options	Part No.
• Steady rest 280-400 mm	250937
• Steady rest 50-300 mm	250936
• Steady rest 130 - 370 mm	250935
• 4-jaw lathe chuck, cast-iron, 457 mm	250103
• E-Forceturn 630/800 spare part package for 100350 - 100355	259213

For additional options for this machine, visit our website and search for Forceturn 630 • 800 (Product Search)

## Specifications Forceturn

		630.15	630.30	630.50	800.15	800.30	800.50
<b>Working area</b>							
Turning diameter over bed	mm	670	670	670	818	818	818
Bed width	mm	450	450	450	450	450	450
Center height	mm	335	335	335	420	420	420
Turning-Ø over support	mm	400	400	400	570	570	570
Workpiece length (max.)	mm	1.600	3.100	5.100	1.600	3.100	5.100
X-axis travel	mm	450	450	450	450	450	450
Z-axis travel	mm	1.500	3.000	5.000	1.500	3.000	5.000
<b>Headstock</b>							
Speed range	1/min	27 - 2.250	27 - 2.250	27 - 2.250	20 - 1.500	20 - 1.500	20 - 1.500
Spindle mount		D1-8	D1-8	D1-8	A1-11	A1-11	A1-11
Spindle bore	mm	85	85	85	105	105	105
<b>Feed</b>							
Rapid feed X- / Z-axis	mm/min	5.000	5.000	5.000	5.000	5.000	5.000
<b>Tooling</b>							
Number of tool stations	Pieces	4	4	4	4	4	4
<b>Accuracies</b>							
Positioning accuracy X-axis	mm	0,015	0,015	0,015	0,015	0,015	0,015
Positioning accuracy Z-axis	mm	0,015	0,02	0,03	0,015	0,02	0,03
Repeatability X-axis	mm	0,007	0,007	0,007	0,007	0,007	0,007
Repeatability Z-axis	mm	0,007	0,01	0,015	0,007	0,01	0,015
<b>Tailstock</b>							
Tailstock quill stroke	mm	170	170	170	170	170	170
Tailstock quill taper / Ø	mm	MT 5 / 105	MT5 / 4	MT5 / 4	MT5 / 4	MT5 / 4	MT5 / 4
<b>Drive capacity</b>							
Main drive motor rating (cont/30 min)	kW	15 / 22	15 / 22	15 / 22	15 / 22	15 / 22	15 / 22
Motor rating X- / Z-axis	kW	2 / 3,6	2 / 3,6	2 / 3,6	2 / 3,6	2 / 3,6	2 / 3,6
Total power consumption	kVA	40	40	40	40	40	40
<b>Measures and weights</b>							
Overall dimensions (length x width x height)	m	4x2,25 x2,25	5,5x2,25 x2,25	7,5x2,25 x2,45	4x2,25 x2,25	5,5x2,25 x2,25	7,5x2,25 x2,45
Weight	kg	4.100	5.600	7.600	4.500	6.000	8.000
Part No.		100350	100351	100352	100353	100354	100355



SIEMENS

- Siemens 828D with ShopTurn
- 8-station servo tool turret
- Hydr. power chucks
- Tailstock with hydr. quill

## Highlights

- Comprehensive bandwidth of technology cycles
- Features an ergonomic control layout

## Machine Design

- Heavy ribbing of the machine frame and wide hardened V-guides for heavy-duty machining
- Headstock and main spindle are designed for constant precision and optimum temperature balance
- High-quality spindle bearings ensure error-free continuous operation

- The heavy-duty tailstock with hydraulic quill is easy to handle and features high clamping force
- Completely lockable machine enclosure with easy access via sliding door

## Spindle

- Hydraulic chuck with adjustable holding force included in standard equipment

## Tool Changer

- An automatic 8-station servo-driven tool turret is part of the standard package and ensures maximum flexibility and productivity



## Standard Equipment

Siemens 828D Basic, ShopTurn, 8-station servo tool post, 2 electronic hand-wheels, hydraulic 3-jaw chuck, automatic central lubrication, hydr. tailstock, cooling system, work lamp, operating tools, operating manual and programming instructions

## Options

Options	Part No.
• Chain-type chip conveyor for Numturn up to 1500 mm workpiece length	251851
• steady rest 25-125 mm	252145
• Steady rest 125-220 mm	252146
• steady rest 220-310 mm	253863
• follow rest 20-80 mm	252147
• Chain-type chip conveyor (2x) for Numturn 500/2000;660/1500	251866

Both axes can be positioned via an electronic hand-wheel

## Specifications Numturn

		500/1000	500/1500	500/2000	660/1000	660/1500	660/2000
<b>Working area</b>							
Workpiece length (max.)	mm	920	1.450	1.950	920	1.450	1.950
Turning-Ø over bed (max.)	mm	500	500	500	660	660	660
Turning-Ø over support	mm	300	300	300	450	450	450
Turning length (max.)	mm	800	1.280	1.780	800	1.280	1.780
<b>Travels</b>							
Travel X-axis	mm	250	250	250	350	350	350
Travel Z-axis	mm	920	1.420	1.900	920	1.420	1.900
<b>Headstock</b>							
Speed range	1/min	30 - 1.600	30 - 1.600	30 - 1.600	30 - 1.600	30 - 1.600	30 - 1.600
Spindle mount		A2-8	A2-8	A2-8	A2-8	A2-8	A2-8
Lathe chuck diameter	mm	250	250	250	315	315	315
Spindle capacity with draw tube	mm	70	70	70	70	70	70
<b>Rapid feed</b>							
Rapid feed X-axis	mm/min	4.000	4.000	4.000	6.000	6.000	6.000
Rapid feed Z-axis	mm/min	8.000	8.000	8.000	8.000	8.000	8.000
<b>Tooling</b>							
Number of tool stations	positions	8	8	8	8	8	8
<b>Accuracies</b>							
Positioning accuracy X-axis	mm	± 0,006	± 0,006	± 0,006	± 0,006	± 0,006	± 0,006
Positioning accuracy Z-axis	mm	± 0,008	± 0,008	± 0,008	± 0,008	± 0,008	± 0,008
Repeatability X-axis	mm	± 0,005	± 0,005	± 0,005	± 0,005	± 0,005	± 0,005
Repeatability Z-axis	mm	± 0,008	± 0,008	± 0,008	± 0,008	± 0,008	± 0,008
<b>Tailstock</b>							
Tailstock taper	MT	5	5	5	5	5	5
Tailstock quill diameter	mm	75	75	75	75	75	75
Tailstock quill stroke	mm	150	150	150	150	150	150
<b>Drive capacity</b>							
Motor rating main drive	kW	9	9	9	9	11	11
Main drive, continuous load	kW	6	6	6	6	7,5	7,5
Torque of drive X	Nm	10	10	10	10	10	10
Torque of drive Z	Nm	15	15	15	15	15	15
Motor rating coolant pump	kW	0,125	0,125	0,125	0,125	0,125	0,125
<b>Measures and weights</b>							
Overall dimensions (length x width x height)	m	3,12x1,76 x1,84	3,65x1,76 x1,84	4,12x1,75 x1,84	3,12x1,97 x1,84	3,62x1,97 x1,84	4,12x1,97 x1,84
Weight	kg	3.000	3.300	3.600	3.200	3.600	4.000
Part No.		182130	182131	182132	182133	182134	182135



- Siemens 808 D Advance TTL
- VDI - tool turret
- Hydraulic power chuck
- Hydraulic tailstock

- Numturn SI including hydraulic chuck (200 mm) with adjustable holding force, and 8-station tool turret
- Manually transverse the X- and Z-axes via 2 electronic hand wheels
- Induction-hardened, ground guideways
- Longitudinal and transverse movements via high-quality preloaded ball screws and servo drives



VDI 30 tool turret with 8 stations



- Smart central lubrication system for low-maintenance operation
- The main spindle is driven by a high-torque servo motor
- USB port for easy data transfers

### SINUMERIK 808D ADVANCE - the perfect solution for modern standard machines

- In combination with a new generation of spindle and axis drives, the SINUMERIK 808D ADVANCE with 8.4" LCD provides an innovative ready-to-use digital CNC solution for modern standard machines
- This is topped by a guaranteed superior price/performance ratio
- CNC and drive communicate via a high-speed bus to ensure efficient positioning control plus high precision and optimum cutting performance

### Standard Equipment

Siemens 808D Advanced TTL control, hydr. tailstock, 2 electronic hand-wheels, hydr. 3-jaw chuck Ø 200 mm, 8-station turret, automatic central lubrication, work lamp, operating tools, operating manual and programming instructions

### Specifications

### Numturn 420 SI

Working area		
Workpiece length (max.)	mm	1.000
Turning diameter over bed	mm	420
Turning-Ø over support	mm	230
Travels		
Travel X-axis	mm	220
Travel Z-axis	mm	920
Headstock		
Spindle speed	1/min	60 - 3.000
Spindle mount		A2-6
Spindle bore	mm	62
Spindle bore with draw tube	mm	48
Rapid feed		
Rapid feed X-axis	mm/min	4.000
Rapid feed Z-axis	mm/min	8.000
Tooling		
Number of tool stations	Pieces	8
Accuracies		
Positioning accuracy X-axis	mm	0,006
Positioning accuracy Z-axis	mm	0,008
Repeatability X-axis	mm	0,005
Repeatability Z-axis	mm	0,008
Tailstock		
Tailstock taper	MT	4
Tailstock quill diameter	mm	60
Tailstock quill stroke	mm	100
Drive capacity		
Motor rating main drive	kW	7,5
Motor rating coolant pump	kW	0,125
Motor rating X-axis	kW	1,5
Motor rating Z-axis	kW	1,5
Measures and weights		
Overall dimensions (length x width x height)	m	2,85x1,58x1,75
Weight	kg	2.750
Part No.		182189



48 mm spindle bore in draw tube



Option: KNUTH-FlexLoader 10 Loading System (Part. No. 100128)

### Options

### Part No.

• KNUTH-FlexLoader 10	100128
• Coolant Concentrate 5 Ltr.	103184
• Live Center MT 4	106755
• Power Worker Metal Cutter	123040



Experience our machines in action!



**For more machines of this series, including machines with driven tools, please visit our website**



Heavy machine bed with hardened and ground guides

### Premium heavy-duty lathe for customized productivity and long machining distances

- Heavy ribbing of the 45° inclined bed with wide box ways ensures excellent vibration damping, especially during continuous cutting operations.
- This design is very spacious, featuring a large work space for tools and improved chip removal
- A wide support saddle with maximum guide length will result in significantly more stability and much less vibration
- The preloaded ball screws connect to powerful drives via a zero-loss transmission clutch, and extensive bilateral bearings ensure high axial and radial rigidity and minimize deviations caused by heating and preloading of spindle
- Excellent rigidity and minimum influence of fluctuating operating temperatures are possible due to an innovative and massive spindle head design
- The main spindle is designed for demanding loads and lasting accuracy, it includes precision dual cylinder roller bearings on both sides, plus additional angular ball bearings on both sides of the front bearings
- The rigid tailstock for shaft machining provides additional flexibility in production operations
- The design with 2 additional box ways ensures collision-free tailstock movements. Extra long guideways, superior rigidity and precision of guides result in excellent vibration damping even during heavy machining operations
- Automatic tailstock is available as an option.
- Servo-turret for quick and precise tool changes
- L models offer an additional center width for even more capacity
- Optionally, a hydraulically self-centering rest from SMW can be used, and the included tailstock allows machining of long workpieces

### Fanuc 0i TF control

- Easy programming and operation, short learning curve

## Standard Equipment

CE, Fanuc 0i TF control, 10.4" LCD color monitor, USB interface, R232 interface, 12-station tool holder, programable tailstock, hydraulic 3-jaw chuck with soft jaws, set of soft jaws, foot switch for 3-jaw chuck, chuck close/open confirm switch, hydraulic unit, coolant system, air and coolant spray wand, central lubrication, LED work lamp, 3-color signal lamp (LED), door lock, machine feet, operating tools

## Options

## Part No.

• Infrared receiver 91.50 for Stahlwerk machines	251598
• Air Blower	251621
• Automatic door	251637
• Set of hard jaws for 18" chuck	251667
• Air condition for electric cabinet	251693
• Manual steady rest (Ø 300-400 mm)	251711

For additional options for this machine, visit our website.

## Specifications TAURUS

		250	300L	450L
<b>Working area</b>				
Turning-Ø over bed (max.)	mm	610	610	775
Swing-Ø over cross slide (max.)	mm	480	480	630
Turning diameter (max.)	mm	400	400	690
Turning length (max.)	mm	1.080	2.080	2.265
<b>Travels</b>				
Travel X-axis	mm	230	230	350
Travel Z-axis	mm	1.130	2.130	2.330
Angle of slant bed	deg	45	45	45
<b>Headstock</b>				
Bar capacity (incl. chuck)	mm	76	90	119
Spindle speed	1/min	3.500	3.000	2.000
Spindle mount		A2-8	A2-8	A2-11
Spindle bore	mm	86	105	132
Spindle torque max. (steps)	Nm	470	470	2.628
Spindle drive method		Belt	Belt	Belt
Lathe chuck diameter	mm	250	300	450
<b>Rapid feed</b>				
Rapid feed X-axis	mm/min	20.000	20.000	20.000
Rapid feed Z-axis	mm/min	24.000	18.000	18.000
<b>Feed</b>				
Feed force X-axis (cont./max.)	kN	15,7 / 35,3	15,7 / 35,3	18,4 / 52,1
Feed force Z-axis (cont./max.)	kN	12,5 / 28,2	10,4 / 23,5	23,9 / 81,9
<b>Tooling</b>				
Tool changer type		Servo	Servo	Servo
Number of tool stations	Pieces	12	12	12
Shank size	mm	25x25	25x25	32x32
Boring bar mount diameter	mm	50	50	60
Turret indexing time	sec	0,2	0,2	0,25
<b>Accuracies</b>				
Repeatability X-axis	mm	± 0,005	± 0,005	± 0,003
Repeatability Z-axis	mm	± 0,01	± 0,01	± 0,006
<b>Tailstock</b>				
Tailstock quill diameter	mm	110	110	160
Tailstock quill stroke	mm	100	100	150
Tailstock taper	MT	5	5	5
<b>Drive capacity</b>				
Motor rating main drive	kW	18,5	18,5	37
Main drive, continuous load	kW	15	15	30
Motor rating X-axis	kW	3	3	7
Motor rating Z-axis	kW	3	3	6
Total power consumption	kVA	30	30	57
<b>Measures and weights</b>				
Overall dimensions (length x width x height)	m	3,92x1,81x2,05	5,24x1,81x2,02	5,81x2,18x2,35
Weight	kg	7.100	8.600	13.200
Part No.		181175	181131	181139

**Premium turning center with large center width,  
C-axis and driven tools**



Merkur 245 LMB machine is shown

- **Productive: EWS turret with driven tool stations**
- **Premium: best machine quality and high-quality components**
- **Reliable: Fanuc control technology**
- Additional options and automation solutions allow maximum customization to meet any requirements
- The rigid tailstock for shaft machining provides additional flexibility in production operations
- Selectable options for max. application versatility
- Perfectly organized layout and well-designed details ensure maximum operator comfort and a comfortable work environment



Turret with servo motor and bi-directional tool selection



Heavy ribbing of the 45° inclined bed ensures excellent vibration damping for superior surface quality

## Standard Equipment

CE, Fanuc Oi TF control, 10.4" LCD color monitor, USB interface, R232 interface, 12 station tool holder (incl. 2 radial and 2 axial), manual tailstock, live center, hydraulic 3-jaw chuck with soft jaws, set of soft jaws, foot switch for 3-jaw chuck, chuck close/open confirm switch, hydraulic unit, coolant system, air and coolant spray wand, central lubrication, LED work lamp, 3-color signal lamp (LED), door lock, machine feet, operating tools

## Options

## Part No.

• Tool pre setter Renishaw HPR A (portable)	251805
• Fanuc Manual Guide i	251658
• Chip conveyor Hinged Belt (rear)	251685
• Chip conveyor Hinged Belt (side)	251688
• Bar feeder interface	251735
• Part catcher box version	251742

## Specifications

## Merkur 180MR

## Merkur 245LMB

Working area			
Turning-Ø over bed (max.)	mm	490	550
Turning-Ø over support	mm	360	360
Turning diameter (max.)	mm	270	280
Turning length (max.)	mm	380	490
Travels			
Travel X-axis	mm	160	200
Travel Z-axis	mm	390	550
Headstock			
Bar capacity (incl. chuck)	mm	45	76
Spindle speed	1/min	6.000	3.500
Spindle mount		A2-5	A2-8
Lathe chuck diameter	mm	150	250
Angular resolution, C-axis	deg	360 (0,001)	360 (0,001)
Rapid feed			
Rapid feed X-axis	mm/min	32.000	24.000
Rapid feed Z-axis	mm/min	32.000	24.000
Tooling			
Tool changer type		Servo	Servo
Number of tool stations	positions	12 / BMT 45	12 / BMT 55
Speed, driven tools	1/min	5.000	5.000
Accuracies			
Repeatabilities	mm	± 0,003	± 0,003
Positioning accuracies	mm	± 0,005	± 0,0075
Tailstock			
Tailstock quill stroke	mm	80	80
Tailstock taper	MT	4	4
Drive capacity			
Motor rating main drive	kW	15	15
Main drive, continuous load	kW	11	11
Motor rating, driven tools	kW	3,7	5,5
Measures and weights			
Overall dimensions (length x width x height)	m	2,4x1,46x1,64	2,96x1,65x1,9
Weight	kg	3.050	4.500
Part No.		181202	181129



Actual machine may vary slightly



### Compact premium lathe series for batch productions

- Fast: Linear guides for reliable precision
- Reliable: Fanuc control technology
- Expandable: many options available
- M models feature driven tools and C- axis
- L models feature an additional 130 mm center width

### Machine bed

- The heavily ribbed 45° inclined bed frame features premium linear guides for superior thermal and structural stability

### Main spindle and headstock

- Thermal stability is achieved by strictly symmetrical builds and cooling structures that ensure consistent cooling air circulation around the entire spindle

### Tailstock

- The design with 2 additional box ways ensures collision-free tailstock movements. Extra long guideways, superior rigidity and precision of guides result in excellent vibration damping even during heavy machining operations

### Fanuc 0i TF control

- Easy programming and operation, short learning curve

### Tool turret

- Servo-driven turret for quick and precise tool changes

## Standard Equipment

Fanuc Oi TF control, 6-station tool holder (TLM model), driven tool holder radial (TLM model), driven tool holder axial (TLM model), CE, 10.4" LCD color monitor, USB interface, R232 interface, manual tailstock, live center, hydraulic 3-jaw chuck with soft jaws, set of soft jaws, foot switch for 3-jaw chuck, chuck close/open confirm switch, hydraulic unit, coolant system, air and coolant spray wand, central lubrication, LED work lamp, 3-color signal lamp (LED), door lock, machine feet, operating tools

## Options

## Part No.

• Chip conveyor Hinged Belt (side)	251688
• Air condition for electric cabinet	251693
• Coolant pump upgrade to 1.8 KW	251702
• Bar feeder interface	251735
• Transformator for suitable power supply	251748
• Tool pre setter Renishaw HPRA (portable)	251805

For additional options for this machine, visit our website.

## Specifications ORION

		6TLM	6TL	10TLM	10TL
<b>Working area</b>					
Turning-Ø over bed (max.)	mm	480	480	480	480
Swing-Ø over cross slide (max.)	mm	285	285	285	285
Turning diameter (max.)	mm	190	280	190	280
Turning length (max.)	mm	390	520	355	485
<b>Travels</b>					
Travel X-axis	mm	165	165	160	160
Travel Z-axis	mm	400	520	380	480
Angle of slant bed	deg	45	45	45	45
<b>Headstock</b>					
Bar capacity (incl. chuck)	mm	44	44	74	74
Spindle speed	1/min	6.000	6.000	3.500	3.500
Spindle mount		A2-5	A2-5	A2-8	A2-8
Spindle bore	mm	55	55	87	87
Lathe chuck diameter	mm	150	150	250	250
Angular resolution, C axis	deg	360 (0,001)	-	360 (0,001)	-
<b>Rapid feed</b>					
Rapid feed X-axis	mm/min	30.000	30.000	30.000	30.000
Rapid feed Z-axis	mm/min	30.000	30.000	30.000	30.000
<b>Tooling</b>					
Tool changer type		Servo / VDI 30	Servo	Servo / VDI 30	Servo
Number of tool stations	Pieces	12	10	12	10
Shank size	mm	20x20	-	20x20	25x25
Boring bar mount diameter	mm	32	32	32	32
Speed, driven tools	1/min	5.000	-	5.000	-
<b>Accuracies</b>					
Repeatability	mm	± 0,003	± 0,003	± 0,003	± 0,003
Positioning accuracy	mm	± 0,005	± 0,005	± 0,005	± 0,005
<b>Tailstock</b>					
Tailstock quill diameter	mm	65	65	65	65
Tailstock quill stroke	mm	80	80	80	80
Tailstock taper	MT	4	4	4	4
<b>Drive capacity</b>					
Motor rating main drive	kW	7,5	15	7,5	15
Main drive, continuous load	kW	5,5	11	5,5	11
Motor rating, driven tools	kW	3	-	3	-
Motor rating X- / Z- axis	kW	1,6	1,8	1,6	1,8
<b>Measures and weights</b>					
Overall dimensions (length x width x height)	m	2,26x1,67x1,57	2,26x1,67x1,57	2,26x1,67x1,57	2,26x1,67x1,57
Weight	kg	3.050	3.000	3.400	3.400
Part No.		181111	181109	181117	181116

# Highest Performance in Hazardous Situations

Global Player Minimax manufactures extinguishing and fire protection technology products with **Roturn 400 C** CNC inclined-bed lathes from KNUTH Machine Tools.



## What convinced them to turn to KNUTH?

- Machine: proven quality, high precision, excellent price/performance ratio
- Consultation: individual recording of all requirements on site, growth-oriented solution
- Service: live demo and quick availability of machine, fast provision of optional equipment
- Advantage: customer proximity and rapid response times

## From Northern Germany Around the Globe

In 1902, the company's founder, Wilhelm Graff, put the legendary conical bags on the market as handy extinguishing devices. Since then, the German company has continued to grow and build its competencies and product lines in the areas of extinguishing and fire protection technologies. Today's Minimax Viking Group has more than 8,800 employees on all continents and annual sales of over 1.6 billion euros. Minimax is the worldwide second largest fire extinguishing and fire protection equipment manufacturer and maintains its headquarters plus several R&D facilities and manufacturing plants in Bad Oldesloe, located in Germany's most northern state Schleswig/Holstein. Minimax is also building a new production line for dry sprinkler systems, with which its United States sister company Viking has already been very successful. "Dry sprinkler systems are used where temperatures are below freezing, in space or in large freezers," explains Dieter Donner, mechanical manufacturing foreman. "The extinguishing water isn't released into the system unless the air leaves the pipes."

## Roturn 400 C turns with consistent high quality

The pipes for these systems are coated steel pipes that have to be threaded on both sides. When looking for a lathe that could produce them quickly and with consistent good quality, one of the companies Donner contacted was KNUTH Machine Tools. "We are already using lots of KNUTH circular saws, lathes, and a drill press and are very satisfied with the quality," says Donner.

Andreas Hendrich, responsible for KNUTH's sales in northern Germany, responded to Minimax's requirements directly on site: "We knew that we wanted to provide Minimax with an optimal production solution and at the same time





The highest precision is required when turning the thread. The steel pipes are later precisely connected to form lines for dry sprinkler systems.



The preliminary work at Minimax is done by the KHK 350 semi-automatic circular saw with pneumatic workpiece clamping, also from KNUTH. It brings the steel pipes exactly to the correct length.



Foreman Dieter Donner (left) here with Andreas Hendrich, KNUTH Sales

with precision lathing to ensure the reliability and safety of the end customers' systems."

Hendrich recommended the Roturn 400 C CNC inclined bed lathe, whose heavy-duty frame guarantees high rigidity and good chip removal. In addition, the precise linear guides in the X- and Z-axes ensure excellent stability and accuracy even under high loads. "It guarantees high process reliability, especially for this sensitive part production," says Hendrich.

With its 15-kW main shaft motor, the Roturn 400 C is capable of high torque in all speed ranges, and the Siemens 828 D basic control meets all current control technology requirements. With the easy-to-use dialogue-oriented user controls, the machine operator can quickly and accurately adjust settings and perform maintenance.

#### Cost-Effective Solution for Multi-Shift Operation

Together with his supervisor, Donner evaluated the advantages of the machine tool at the KNUTH headquarters in Wasbek. "The spacious area is

a real plus," Donner approves, "in addition to the good price-performance ratio and how quickly the machine could be made available." KNUTH quickly equipped the Roturn 400 C with a longer shaft, allowing it to cut pipes up to 120 cm long.

The Roturn 400 C is a great choice for its process reliability and high-quality output, and also as a cost-effective lathe for multi-shift operation, which is already planned for production at Minimax. Donner has only good things to say about working with the people at Wasbek: "To buy a new machine, I will always turn to KNUTH."

Minimax GmbH & Co. KG  
 Industriestraße 10/12, Bad Oldesloe  
 Tel. + 49 4531 803-0  
 www.minimax.com



See this machine  
in action on  
YouTube



## Extensive standard equipment

- Heavy machine frame with inclined bed ensuring high rigidity and easy chip removal
- Precise linear guides in X and Z for high stability and accuracy even at highest loads
- The enclosed work space is easily accessible through a large sliding door
- Future-proof: the Siemens 828 D Basic control meets all requirements for advanced control technology
- The 8-station tool turret ensures a large work area and quick and precise tool changes
- A powerful 15 kW headstock motor delivers high torque across the entire speed range



**Siemens Sinumerik 828 D Basic for turning applications - a compact and user-friendly solution for lathes**

## Proven record:

- Easy, dialog-guided user interface
- Complete bandwidth of technology cycles
- High performance and precision



- Hydraulic 200 mm (Roturn 400 C) / 250 mm (Roturn 402 C) 3-jaw chuck with through-hole
- Tailstock with hydraulically operated quill with a maximum stroke of 85 mm
- Automatic central lubrication system ensures reliable lubrication of guideways
- Hinged belt conveyor and high-performance coolant system included in standard equipment

### Standard Equipment

Siemens 828 D Basic control, hydr. 3-jaw lathe chuck 200 mm (Roturn 400 C) / 250 mm (Roturn 402 C) with through-hole, hydr. tailstock, automatic central lubrication, Chain-type chip conveyor, heat Exchanger for electric control cabinet, closed work space, work lamp, coolant system, air gun, coolant system flush gun, operating tools, operator manual

Options	Part No.
• Portabot 2811 linear gantry robot	253056

8-station tool turret reduces downtime

### Specifications

		Roturn 400 C	Roturn 402 C
<b>Working area</b>			
Workpiece length (max.)	mm	430	430
Center height	mm	200	200
Turning diameter over bed	mm	400	400
Turning diameter over support	mm	250	250
<b>Travels</b>			
Travel X-axis	mm	200	200
Travel Z-axis	mm	450	450
<b>Headstock</b>			
Lathe chuck diameter	mm	200	250
Speed range	1/min	50 - 3.000	50 - 2.000
Spindle mount		A2-6	A2-8
Spindle bore	mm	62	86
Spindle bore with draw tube	mm	46	75
<b>Tool Head</b>			
Number of tool stations	Pieces	8	8
Tool shank dimensions	mm	25x25	25x25
Boring bar mount diameter	mm	40	40
<b>Rapid feed</b>			
Rapid feed X-axis	mm/min	16.000	16.000
Rapid feed Z-axis	mm/min	20.000	20.000
<b>Tailstock</b>			
Tailstock taper	MT	5	5
Tailstock quill diameter	mm	88	88
Tailstock quill stroke	mm	85	85
<b>Drive capacity</b>			
Main motor rating	kW	15 / 11	15 / 11
Motor rating coolant pump	kW	0,18	0,18
<b>Measures and weights</b>			
Overall dimensions (length x width x height)	m	3,8x1,87x1,91	3,8x1,87x1,91
Weight	kg	3.340	3.400
Part No.		180633	180628

# Roturn 400 GT

Inclined bed lathe with linear tool changer and driven tools



Roturn 400 GT is shown with optional accessories



See this machine  
in action on  
YouTube 



Siemens Sinumerik 828 D Basic for turning applications - a compact and user-friendly solution for lathes

## Extensive standard equipment

- Linear tool changers are ideal for the serial production of smaller workpieces - shortest tool changing times and absolutely reliable features ensure increased productivity
- A hydraulic 160 mm 3-jaw chuck is included in the standard equipment
- Chip conveyor and powerful coolant system are also included in the standard equipment
- Driven tool for radial and axial machining

### Options

Options	Part No.
• Electric turret with 8 tools	252743
• Bar feeder RoFeeder 65	253018

### Specifications

	Roturn 400 GT	
Workpiece length (max.)	mm	380
Center height	mm	200
Turning diameter over bed	mm	400
Turning-Ø over support	mm	140
Speed range	1/min	60 - 5.000
Spindle mount		A2-5
Number of driven tools	Pieces	1
Main motor rating	kW	7,5 / 5,5
Weight	kg	2.500
Part No.		180632

### Standard Equipment

Siemens 828 D Basic control, hydr.160 mm 3-jaw lathe chuck with through-hole, driven tool (radial), automatic central lubrication, chain-type chip conveyor, heat Exchanger for electric control cabinet, closed work space, LED work lamp, coolant system, operating tools, operator manual

# RoFeeder 65 S

Industrial-grade short rod loader for the Roturn 400 series and CNC lathes



Flexible processing of rods with diameters up to 65 mm

- This automatic rod loader features a universal design and can be used on many CNC production machines
- No spindle speed limit; however, machine- and material-specific spindle reduction bushings (available upon request) will be required
- The I/O interface for all commonly used CNC lathes is very easy to set up
- All components are very robust for an almost maintenance-free operation
- The standard handheld control unit simplifies the rod loader's set-up and operation
- Assembly cost quote upon request (Part No. 270061)



The rod magazine control can be configured at the user-friendly control panel

## Specifications

## RoFeeder 65 S

### General

Bar diameter	mm	5 - 65
Rod length	mm	280 - 1.550
Spindle height	mm	850 - 1.250
Air supply	kg/cm <sup>2</sup>	5 - 7

### Drive capacity

Power supply voltage	V/Hz	400 /50
----------------------	------	---------

### Measures and weights

Weight	kg	320
Part No. (no assembly cost)		253018

## PLC control

- The PLC control features a large LCD, is user-friendly and comfortable
- The return stroke can be adjusted by the operator for custom requirements
- Self-diagnostics help minimize idle time during troubleshooting
- The remaining piece length is defined by parameters to support highly efficient material utilization

## Standard Equipment

PLC control

# CNC Drilling-milling machines

**See for yourself live:** Many models are in stock or can be viewed and tried out at a user's location near you. Make a demonstration appointment! [info@knuth.com](mailto:info@knuth.com)



## Experience our machines in action!

With our YouTube channel KNUTH Machine Tools, you stay up to date with all the news and developments.



Drilling-milling machine

## BO T 130 CNC

Boring diameter **250 mm**

Traverse path of X-axis **1.300 - 1.600 mm**

4 side machining with CNC working table

Page 38 / 39



CNC drilling-milling machine

## BO T 110 CNC

Boring diameter **240 mm**

Traverse path of X-axis **1.200 - 1.800 mm**

The rotary table features a large table center support area that can handle workpiece weights up to 5 tons

Page 40 / 41



CNC drilling-milling machine

## BO 90 CNC

Boring diameter **200 mm**

Traverse path of X-axis **700 mm**

Modern, compact and powerful with clamping table that can be indexed in 5° increments

Page 42 / 43



BO T 130 CNC shown



Wide guideways

- The large, heavily ribbed box-column base is made of premium cast-iron to ensure stability and rigidity even under very heavy machining loads
- The massive machine frame features wide guideways and is designed for table loads up to 5 tons
- The CNC work table indexing in 5° steps allows flexible 4-sided complete machining of the workpiece without retooling
- The powerful motor ensures constant torque across the entire infinitely variable speed range
- The Siemens 828D CNC-ensures high productivity and precision during production
- Excellent functional interaction between hardware and software ensures high dynamics, while motors and drive technologies provide the necessary precision

- Telescoping stainless steel covers protect the guides from chips and dirt
- Precision preloaded ball screws in all axes ensure high accuracy with low wear and maintenance
- Easy maintenance due to standard central lubrication system
- Optionally the machine can be equipped with a tool changer



## Options

	Part No.
• Arm type ATC, 24 Tools	253427
• 1° indexing CNC work table	253429
• 0.001° indexing work table for BO T 130 (L) CNC	253430
• Increase Y-axis travel with extra 400 mm	253431

## Standard Equipment

Siemens 828D control, electronic hand-wheel, 5° indexing CNC work table, RS-232 interface, work lamp, central lubrication, coolant system, operator manual

## Specifications

		BO T 130 CNC	BO T 130 L CNC
<b>Working area</b>			
Drilling capacity	mm	50	50
Counterbore diameter (max.)	mm	250	250
Table set up area	mm	1.350x1.000	1.350x1.000
Table load capacity	kg	5.000	5.000
Spindle center-to-table distance	mm	0 - 1.200	0 - 1.200
Number of T-slots	Pieces	7	7
T-slots, width	mm	22	22
T-slots, spacing	mm	125	125
Table indexing	deg	5	5
<b>Travels</b>			
Travel X-axis	mm	1.300	1.600
Travel Y-axis	mm	1.200	1.200
Travel Z-axis	mm	1.200	1.200
Travel W-axis	mm	550	550
<b>Headstock</b>			
Speed range	1/min	(2) 12 - 1.200	(2) 12 - 1.200
Spindle diameter	mm	130	130
Spindle torque (max.)	Nm	1.500	1.500
Spindle mount		BT 50	BT 50
Facing slide speed	1/min	4 - 125	4 - 125
<b>Rapid feed</b>			
Rapid feed X-axis	mm/min	10.000	10.000
Rapid feed Y-axis	mm/min	10.000	10.000
Rapid feed Z-axis	mm/min	10.000	10.000
Rapid feed W-axis	mm/min	5.000	5.000
Rapid feed B-axis	mm/min	5,5	5,5
<b>Feed</b>			
Feed X-axis	mm/min	5 - 2.000	5 - 2.000
Feed Y-axis	mm/min	5 - 2.000	5 - 2.000
Feed Z-axis	mm/min	5 - 2.000	5 - 2.000
Feed W-axis	mm/min	5 - 2.000	5 - 2.000
<b>Accuracies</b>			
Positioning accuracy X-axis	mm	0,04	0,04
Positioning accuracy Y-axis	mm	0,04	0,04
Positioning accuracy W-axis	mm	0,04	0,04
Positioning accuracy Z-axis	mm	0,04	0,04
Repeatability X-axis	mm	0,02	0,02
Repeatability Y-axis	mm	0,02	0,02
Repeatability T-axis	mm	0,02	0,02
Repeatability W-axis	mm	0,02	0,02
Work table rotation accuracy	"	10	10
Work table repeatability	"	4	4
<b>Drive capacity</b>			
Main motor rating	kW	17 / 20,5	17 / 20,5
<b>Measures and weights</b>			
Overall dimensions (length x width x height)	m	7,1x6,6x3,6	7,1x7x3,6
Weight	kg	17.500	18.500
Part No.		100082	100083



Setup table with manual rotation and manual face slide as standard

- The state-of-the-art machine frame is constructed of premium cast-iron to ensure stability and rigidity even under very heavy machining loads
- 4-side machining is supported by a manually rotated setup table that can be locked with high precision in 4 positions
- The rotary table features a large table center support area that can handle workpiece weights up to 5 tons
- Spindle and facing slide speeds can be quickly adjusted via an infinitely variable rpm control
- Siemens 828D control and drives guarantee high productivity, wide functionality and maximum precision
- Excellent functional interaction between hardware and software ensure high dynamics, while motors and drive technologies provide the necessary precision

- Precision preloaded ball screws in all axes ensure high accuracy with low wear and maintenance
- The powerful motor ensures constant torque across the entire speed infinitely range
- telescoping steel cover protects the guides from chips and dirt
- Easy maintenance due to standard central lubrication system
- Rotary table with controlled positioning are available as an option

## Options

	Part No.
• 5° indexing CNC work table	253423
• 1° indexing CNC work table	253424
• 0,001° indexing CNC work table	253425
• Increase Y axis travel with extra 400 mm	253426

## Standard Equipment

Siemens 828D control, electronic hand-wheel, manual rotary table with four positions indexing, RS-232 interface, work lamp, central lubrication, coolant system, operator manual

## Specifications

		BO T 110 CNC	BO T 110 L CNC
<b>Working area</b>			
Drilling capacity	mm	50	50
Counterbore diameter (max.)	mm	240	240
Facing slide working diameter (max.)	mm	800	800
Table set up area	mm	1.320x1.010	1.320x1.010
Table load capacity	kg	5.000	5.000
Spindle center-to-table distance	mm	5 - 905	5 - 905
Number of T-slots	Pieces	7	7
T-slots, width	mm	22	22
T-slots, spacing	mm	125	125
Table rotation range		4 x 90°	4 x 90°
<b>Travels</b>			
Travel X-axis	mm	1.200	1.800
Travel Y-axis	mm	900	1.200
Travel Z-axis	mm	1.300	1.300
Travel W-axis	mm	550	550
Facing slide travel	mm	125	125
<b>Headstock</b>			
Speed range	1/min	(2) 12 - 1.100	(2) 12 - 1.100
Spindle diameter	mm	110	110
Spindle Torque (max.)	Nm	1.100	1.100
Spindle mount		BT 50	BT 50
Facing slide speed	1/min	4 - 125	4 - 125
<b>Rapid feed</b>			
Rapid feed X-axis	mm/min	10.000	10.000
Rapid feed Y-axis	mm/min	10.000	10.000
Rapid feed Z-axis	mm/min	10.000	10.000
Rapid feed W-axis	mm/min	5.000	5.000
Rapid feed U-axis	mm/min	124	124
<b>Feed</b>			
Feed X-axis	mm/min	20 - 1.000	20 - 1.000
Feed Y-axis	mm/min	20 - 1.000	20 - 1.000
Feed Z-axis	mm/min	20 - 1.000	20 - 1.000
Feed W-axis	mm/min	20 - 1.000	20 - 1.000
Facing slide feed	mm/min	0,2 - 80	0,2 - 80
<b>Accuracies</b>			
Positioning accuracy X-axis	mm	0,04	0,04
Positioning accuracy Y-axis	mm	0,04	0,04
Positioning accuracy W-axis	mm	0,04	0,04
Positioning accuracy Z-axis	mm	0,04	0,04
Repeatability X-axis	mm	0,02	0,02
Repeatability Y-axis	mm	0,02	0,02
Repeatability T-axis	mm	0,02	0,02
Repeatability W-axis	mm	0,02	0,02
Work table rotation accuracy	"	12	12
<b>Drive capacity</b>			
Motor rating main drive	kW	15	15
<b>Measures and weights</b>			
Overall dimensions (length x width x height)	m	5,5x3,05x2,9	5,5x3,8x3,3
Weight	kg	13.500	16.000
Part No.		100080	100081



See this machine  
in action on  
YouTube



- Heavy-duty cast-iron machine frame plus wide guideways for optimum drilling and milling work results
- Manually indexable rotary table, divisions in 5° increments
- Powerful servo-drives and preloaded ball screws with large diameters ensure precision at high travel speeds
- BT 40 spindle mount with automatic tool clamping
- Pneumatic rotary table ensures maximum angular accuracy and provides simple adjustment of angle settings
- A Siemens 828 D control with servo-driven axes meets all requirements of an advanced CNC concept in programming and handling



Work Table with hardened surface and 360° rotation

## Specifications

## BO 90 CNC

### Working area

Drilling capacity	mm	30
Finish bore	mm	200
Milling capacity	cm <sup>3</sup> /min	55
Table load capacity	kg	1.000
Table dimensions	mm	630x800
Number of T-slots	Pieces	6
T-slots, width	mm	18
Spindle axis-to-table surface distance	mm	570
Table rotation range (5° units)		360

### Travels

Travel X-axis	mm	700
Travel Y-axis	mm	510
Travel Z-axis	mm	800

### Headstock

Spindle speed	1/min	10 - 6.000
Spindle mount		BT 40

### Feed

Feed speed X-axis	mm/min	1 - 2.000
Feed speed Y-axis	mm/min	1 - 2.000
Feed speed Z-axis	mm/min	1 - 2.000

### Accuracies

Positioning accuracies	mm	± 0,008
Repeatabilities	mm	± 0,005
Angular accuracy		± 3"

### Drive capacity

Motor rating main drive	kW	11
-------------------------	----	----

### Measures and weights

Overall dimensions (length x width x height)	m	3,55x2,35x2,1
Weight	kg	4.800
Part No.		180027



Table rotates for multi-sided machining

## Standard Equipment

Siemens 828 D Basic control, pneumatic rotary table, electronic hand-wheel, halogen lights, central lubrication, drill chuck 3-16 mm / B18, tool-holder bits MT4 / B18, reducing sleeves MT3, MT4, MT5, foundation bolts, operating manual and programming instructions

## Options

## Part No.

- |  |        |
|--|--------|
| • E-BO 90CNC spare part package for 180027 | 259116 |
|--|--------|

## Precision Work Under Pressure

Metrol is a family-owned Polish business that uses KNUTH machine tools for its pressure component production.



### What convinced them to turn to KNUTH?

- Machine: compact design with a very wide spectrum of machining applications, reliable series production
- Consultation: CNC with intuitive user interface and easy cycle programming ensures fast operation and minimal training requirements
- Service: machine demo at a reference customer's site in the region, service technician will be on site within 24 hours as needed

**The company is well known for its high-quality pressure components that play a major role in the efficiency and safety of industrial heat exchangers. Their products are used in applications, where strict process temperature control is required. Metrol employs about 40 people, who manufacture about 30.000 components of various types per year, which are shipped directly to large manufacturers in Poland and Germany. "Our main customers are renowned international corporations, who produce heat exchangers for the railroad or shipyard industry," explained Waldemar Klimczuk, the owner of Metrol.**

### Compact CNC Drill Unit Hits the Mark

In 2016, Klimczuk was looking for a horizontal milling/drill press combination for their steel machining requirements. It had to have a small footprint, yet be able to cover a wide spectrum of machining applications. After considering several large CNC drill presses, he quickly realized that these were not suitable for his production needs. Then he came across an image of KNUTH's compact BO 90 CNC, which immediately caught his attention. KNUTH arranged a visit at the facilities of their reference customer, Byd-

goszcz, where Klimczuk personally could check out the machine's many advantages. He never regretted his subsequent purchase decision: "We have used the BO 90 CNC now for three years five to six days per week, and not once did we have any malfunction." The Siemens 828 D control fulfills all programming and handling requirements of a state-of-the-art CNC.

Equipped for maximum precision, the drill unit features powerful servo-drives and preloaded ball screws with large diameters. The simple concept of the table rotation mechanisms ensures plenty of flexibility. It allows users to set up a new batch after 30 to 40 parts have passed, allowing very quick change-overs between components.



Work table with hardened surface and 360° rotation



**KNUTH BO 90 CNC:**

Thanks to the very easy to use, practical table rotation mechanism, users can set up a new batch after 30 to 40 parts have passed, allowing very quick change-overs between components.



**Siemens 828 D Basic:**

Simplicity and user-friendly interface are convincing factors for the customer. "With these features, even new employees with very little CNC experience require only minimal training until they can run the machine efficiently and without problems," added Klimczuk.

**High Precision, Superior Service**

In 2017, Metrol bought a second, considerably larger machine than the BO 110 CNC to fulfill their needs in machining heavier and larger steel parts. "What I really like about these KNUTH drill presses, is their functional design and the user-friendly interface of the CNC control," said Klimczuk. "The programming of cycles is very easy, which is another big advantage." Even new employees with very little CNC experience require only minimal training until they can run the machine efficiently and without problems. The BO 110 CNC is the perfect machine for working with tight tolerances - an important factor for Metrol, who works with micrometer precision. "The quality of this machine was just as convincing as the excellent service," added Klimczuk. "When needed, a service technician will be on site within 24 hours and quickly will find a good solution for the problem at hand."

**KNUTH Is The First Choice**

Their next two machine tools, Klimczuk also purchased from KNUTH. In 2018, an old conventional drill press was replaced with a new KNUTH conventional BO

110 drill press. One year later, an old milling machine suddenly failed, and Klimczuk again found a replacement in the KNUTH catalog. He selected the VFM 5, which features large travels and a heavy vertical cutter head with angular adjustment. Since the machine was in stock, it was quickly delivered to Kamieniec Ząbkowicki, where it was set up and put into operation by a KNUTH technician. Klimczuk was very pleased about the quick deliver, and also about the great price. Other, more expensive machines could have never been fully utilized in their business. Waldemar Klimczuk is convinced: "Any time, I need a new machine tool, KNUTH will always be my first choice."

PP.U.H. Metrol Sp.J  
 ul. Kolejowa 44 - Kamieniec Ząbkowicki  
 Tel. 0048 74 817 31 56, 817 31 54  
 metrol@metrol.com.pl

# CNC milling machines

**See for yourself live:** Many models are in stock or can be viewed and tried out at a user's location near you. Make a demonstration appointment! [info@knuth.com](mailto:info@knuth.com)



## Experience our machines in action!

With our YouTube channel KNUTH Machine Tools, you stay up to date with all the news and developments.



CNC portal machining center

### PBZ CNC

Traverse path of X-axis **2.000 - 4.200 mm**  
Spindle mount **BT 50**

Portal machining center with fixed table for heavy, large-volume workpieces

Page 52 / 53

CNC portal machining center

### Portalo B CNC

Traverse path of X-axis **2.000 - 8.200 mm**  
Spindle mount **BT 50**

High-portal machining center for heavy, large-volume workpieces

Page 54 / 55





CNC vertical machining center

### X.mill

Traverse path of X-axis **400 - 1.000 mm**

Spindle mount **BT 40**

The production class of the vertical machining centers with Siemens, Fanuc or Heidenhain control system

from page 62 onwards



CNC vertical machining center

### Vector

Traverse path of X-axis **650 - 1.400 mm**

Spindle mount **BT 40**

Premium series with extensive individually coordinated accessories

from page 56 onwards



CNC engraving and milling machine

### PFG 2513

Traverse path of X-axis **2.500 mm**

Spindle mount **ISO 30**

Engraving with high drive power and granite machine frame

Page 48 / 49





### Extensive standard equipment

- a major advantage of this machine is the heavy construction with fixed gantry and axis-aligned work table
- the use of natural, precision-machined granite for the machine frame ensures maximum accuracy and stability
- this exclusive material provides complete resistance against corrosion, acids and alkaline solutions
- a powerful vacuum pump ensures a firm hold of the workpiece on the machining table
- the high-quality 7,5kW / 9kW HSD spindle motor (made in Europe) provides a wide rpm range and pneumatic tool clamping
- ceramic bearings at the tool mount and a powerful air cooler provide maintenance-free, highly reliable service
- the linear 8-station tool changer is designed without complex mechanics for short travels and quick tool changes
- all three axes are provided with linear guides and preloaded ball screws for increased accuracy, high precision and excellent rigidity
- syntec CNC controls are known for their performance and reliability and are used worldwide on premium engraving and machining centers
- tool length measurements simplify machine configurations, save time and increase production accuracy
- a highly efficient cold-air nozzle delivers precise cooling of tools and workpiece
- the granite machine frame with fixed gantry and axis-aligned work table is precise and extremely robust



Linear 8-station tool changer



Precision-ground granite elements on all axes

## Specifications

## PFG 2513

Working area	
X-axis travel	mm 2.500
Y axis travel	mm 1.300
Z-axis travel	mm 200
Table set up area	mm 2.500x1.300
Headstock	
Speed range	1/min 6.000 - 24.000
Spindle mount	ISO 30 (DIN 69871)
Feed	
Working speed axe X	mm/min 1.800
Working speed axe Y	mm/min 1.800
Rapid feed	mm/min 10.000
Tooling	
Number of tool stations	Pieces 8
Drive capacity	
Main motor rating	kW 7,5 / 9,0
Measures and weights	
Overall dimensions (length x width x height)	m 3,2x2,2x2
Weight	kg 2.500
Part No.	171960

## Standard Equipment

8-station tool changer, collet chuck ISO 30 (DIN 69871), ER collet set ( 3 / 4 / 6 / 8 / 12 mm, tool length measuring device, syntec control, main spindle motor 7.5/9 kW, draw bolt (DIN 69872), vacuum clamping plate, vacuum pump, cooling air nozzle, operating tools, operator instructions

## Options

## Part No.

• LED Strip 1120 mm	670606
• Carbide Milling Bits	108430
• ER 32 Collet Set 6 pcs.	106052
• E-PFG 2513 spare part package for 171960	259118

# CNC Milling

## Smart solutions for your production

Whether automotive, toolmaking, mechanical engineering or medical device production - all industries rely almost exclusively on CNC technology in their production of high-precision milled parts. Our machines are equipped with controls from leading manufacturers and include first-class support.



## Siemens 828D

SIEMENS

### Increased productivity with SINUMERIK

For workshops, contract work, and high-volume production, there is a large demand for highly productive automation solutions that facilitate the move to full digitalization. From single parts to mass production, whether simple parts or complex workpieces – SINUMERIK CNCs provide the perfect solution for any requirements of machine tool operators.

Its technology-specific system software drastically expands the range of applications for the SINUMERIK 828D. It is perfectly suited for a wide spectrum of applications, from vertical and horizontal machining centers to heavy-duty milling machines and drill presses, and of course also for mold and die production.

- **Robust:** A front control panel made of magnesium die-cast, the panel-based CNC design with a clearly structured interface, and IP65 protection rating make the SINUMERIK 828D a reliable partner even in very harsh environments.
- **Maintenance-free:** Thanks to NV-RAM technology no fan, hard disk or backup battery are required, making the SINUMERIK 828D completely maintenance-free.
- **User-friendly:** A full QWERTY keyboard with tactile keys and a high-resolution 10.4" TFT color display ensure easy operation of the SINUMERIK 828D. USB, CF-Card and RJ45 ports are located at the front panel allowing quick and easy transfer of CNC data.

### Easier and faster from the drawing to the finished part

**ShopMill** is an easy and efficient programming solution that is perfectly suited for CNC milling of single parts and small batches. The software allows for quick entry into CNC technology without major programming efforts or prior CNC knowledge.



# Heidenhain TNC 620



## Precise and practice-oriented

The HEIDENHAIN TNC 620 is a compact and versatile contouring control. Applications range from 3-axis and 3+2-axis machining to 5-axis milling. From an everyday shopfloor perspective, the TNC 620 offers easy operation and extensive features. This makes it especially well suited for use in compact machining centers, like the X.mill or Vector series, and it guarantees superior surface quality with short machining times.

- Workshop-oriented programmability via HEIDENHAIN® plain text dialogs
- **Optimal performance** featuring optimized motion control, short block processing times, and special control strategies
- **Realistic simulations** for a precise and realistic preview of machining operations
- **Optimized Contour Milling (OCM)** for optimized roughing and reaming processes
- **Dynamic Precision** includes multiple functions that improve the contouring accuracy of machine tools, even during high feed rates and complex movements
- **Easy programming** using HEIDENHAIN plain text or G-Code
- Extensive machining and touch-probe cycle packages
- Special function for rapid 3D machining
- **Fast block processing time** (1.5 ms)



# Fanuc Oi-MF



## Simple • Efficient • Intuitive

FANUC Oi has been designed for the utmost ease of use of the machine.

- Easy programming and operation, short learning curve
- User-friendly graphics display for visual verification of parts programs
- Use of existing programs without reprogramming requirements
- High-speed machining and standard nano-interpolation
- Fixed cycles and custom macro B for simplified parts programming
- State-of-the-art functionality, like jolt reduction, nano smoothing, and AI Contour Control II - compatible with previous version series 0 and series Oi models A, B, C and D
- Series Oi Model F are the successor models of the Series 0 and Series Oi, which are the most popular CNC controls worldwide with over 700,000 installed systems
- With up to 4 simultaneously controlled axes, the CNC Series Oi provides the best controls for highly demanding machine tools

**Manual Guide:** all created programs are converted to G-Code in the background. Thus, any program created in an easy dialog mode can be edited anytime in G-Code mode and vice versa. Programs created with G-Code can be downloaded and processed, and programs generated via Manual Guide i can be sent to other machine tools, ensuring maximum compatibility.



- Siemens 828 D control
- Large travel distances, small footprint
- High maximum workpiece weights
- High-powered drives



Compact design with large work space

- Fixed set-up table and moving gantry for machining of very large and heavy workpieces
- This design offers an excellent ratio between machining area and setup area as well as large travel ranges, but has an only slightly larger footprint
- The intrinsically rigid monoblock machine bed design ensures uniform load distribution when handling heavy workpieces
- A combination of linear guides and box ways ensure a long service life plus higher machining speeds and steadfast rigidity
- The gantry is guided on both sides on the Y-axis by two heavy 55 mm linear guides and an additional lateral box way for maximum torsional rigidity
- 2 large linear guideways and an additional stabilizing box way ensure maximum X-axis rigidity
- The combination of 2 roller linear guides and 2 rigid box ways ensures lasting Z-axis precision
- High-quality preloaded ball screws and proven Siemens servo-motors provide dynamic feed and rapid feed on all axes

**Main spindle**

- High drive power and a wide speed range ensure availability of the necessary reserves during heavy-duty machining

**Tool changer**

- The robust arm-less 20-station tool changer brings flexibility to everyday production operations

**Equipment**

- The workspace features large sliding doors in the machine enclosure for great accessibility and easy tooling
- A powerful coolant system combined with the included chip conveyor ensure excellent chip disposal
- Coolant feed through the main spindle is available as an option
- An automatic central lubrication system simplifies maintenance



## Standard Equipment

Siemens 828 D Basic control, electronic handwheel for X- and Z-axes, separate control panel, air gun, automatic central lubrication, coolant system, LED work lamp, spiral chip conveyor & chain type chip conveyor, 20-station tool changer, operating tools, operating manual and programming instructions

## Options

## Part No.

• coolant through spindle for PBZ	253710
-----------------------------------	--------

The combination of large linear guides and flat guides ensure extraordinary stability

## Specifications PBZ CNC

		2012	2516	4016	4020
<b>Working area</b>					
Table dimensions	mm	2.000x1.000	2.500x1.400	4.000x1.400	4.000x1.800
Table load capacity (max.)	kg	12.000	15.000	25.000	30.000
Number of T-slots	Pieces	9	12	16	16
T-slots, width	mm	22	22	22	22
Spindle nose-to-table surface distance	mm	300 - 1.000	200 - 1.000	200 - 1.000	200 - 1.200
Workpiece width (max.)	mm	1.200	1.600	1.600	2.000
<b>Travels</b>					
Travel X-axis	mm	2.000	2.500	4.200	4.200
Travel Y-axis	mm	1.200	1.600	1.600	2.000
Travel Z-axis	mm	700	800	800	1.000
<b>Headstock</b>					
Spindle speed	1/min	6.000	6.000	6.000	6.000
Spindle mount		BT 50	BT 50	BT 50	BT 50
<b>Rapid feed</b>					
Rapid feed	mm/min	15.000	20.000	15.000	15.000
<b>Feed</b>					
Work feed	mm/min	0 - 15.000	0 - 15.000	0 - 15.000	0 - 15.000
Torque	Nm	96 - 144	162 - 243	162 - 243	210 - 315
<b>Tooling</b>					
Number of tool stations	Pieces	20	20	20	20
Tool size Ø x L (max.)	mm	150x250	150x250	150x280	150x280
Workpiece width x height	mm	2.860x1.500	2.860x1.500	2.860x1.500	2.860x1.500
Tool weight max.	kg	15	15	15	15
Tool-changing time	sec	10	10	10	10
<b>Accuracies</b>					
Positioning accuracies	mm	0,01	0,01	0,01	0,01
Repeatability	mm	0,005	0,005	0,005	0,005
<b>Drive capacity</b>					
Motor rating main drive	kW	22,5	25,5	25,5	30
Main drive, continuous load	kW	15	17	17	22
Motor rating X-axis	kW	3,1	4,3	4,3	4,3
Motor rating for Y-axis drive	kW	3,1	4,3	4,3	4,3
Motor rating Z-axis (brakes)	kW	4,3	5,2	5,2	5,2
<b>Measures and weights</b>					
Overall dimensions (length x width x height)	m	5,2x3,4x3,2	5,5x3,75x3,8	6,5x3,75x3,8	7,8x4,1x4
Weight	kg	16.000	20.000	32.000	33.000
Part No.		170003	170004	170007	170012

## Portalo B CNC

Precise machining of heavy and large-volume workpieces with high dynamics



- Siemens 828 D control
- High gantry-type design
- High maximum workpiece weights
- High-power drives

- Cast-iron frame with high gantry design for maximum rigidity, small foot print for efficient and economical operation
- In smaller models with up to 1600 mm wide tables the machine frame is a one-piece construction, while larger models feature separate table and column constructions
- Rigid traverses with drives on both sides - perfect synchronization of drives and dynamics
- Large linear guides in X / Y axis and 4 linear roller guides on Z axis ensure lasting precision
- A fixed table allows machining of extra-heavy workpieces
- Precision preloaded ball screws and proven Siemens servo-motors provide dynamic feed and rapid feed on all axes



Spindle mount with cutter head





20-station tool changer

- A powerful coolant system combined with the included chip conveyor ensures excellent chip disposal and optimum machining conditions
- Optional universal and angle cutter heads allow angular or lateral machining of workpieces
- plus free 1-day training in Wasbek

### Standard Equipment

Siemens 828 D Basic control, electronic handwheel for X and Z axis, separate control panel, air gun, automatic central lubrication, coolant system, work lamp, 2 spiral chip conveyors, CE, 20-station tool changer, operating tools, operating manual and programming instructions

### For additional options

For additional options for this machine, visit our website and search for Portalo B CNC (Product Search)

Specifications Portalo B CNC		1810	2516	3016	4025	6025	8025
<b>Working area</b>							
X axis travel	mm	2.000	2.500	3.200	4.200	6.200	8.200
Y axis travel	mm	1.050	1.600	1.600	2.500	2.500	2.500
Z axis travel	mm	550	800	800	1.200	1.200	1.200
Table dimensions	mm	1.900x1.000	2.500x1.600	3.000x1.600	4.000x2.100	6.000x2.100	8.000x2.100
Table load capacity (max.)	kg	9.000	15.000	20.000	30.000	40.000	60.000
T-slots (number x width)	mm	5x18	7x22	7x22	9x28	9x28	9x28
Spindle nose-to-table surface distance	mm	230 - 780	200 - 1.000	200 - 1.000	350 - 1.550	350 - 1.550	350 - 1.550
<b>Headstock</b>							
Spindle speed	1/min	8.000	8.000	8.000	6.000	6.000	6.000
Spindle mount		BT 50	BT 50	BT 50	BT 50	BT 50	BT 50
<b>Feed</b>							
Rapid feed	mm/min	30.000	20.000	20.000	15.000	15.000	15.000
Work feed	mm/min	0 - 15.000	0 - 15.000	0 - 15.000	0 - 15.000	0 - 15.000	0 - 15.000
Torque	Nm	115 - 172	162 - 243	162 - 243	267,5 - 401	267,5 - 401	267,5 - 401
<b>Tooling</b>							
Number of tool stations	Pieces	20	20	20	20	20	20
Tool size Ø x L (max.)	mm	150x250	150x250	150x250	150x280	150x280	150x280
Workpiece width x height	mm	1.300x730	2.000x750	2.000x950	2.860x1.500	2.860x1.500	2.860x1.500
Tool weight max.	kg	15	15	15	15	15	15
Tool-changing time	sec	6	6	6	6	6	6
<b>Accuracies</b>							
Positioning accuracy	mm	0,01	0,01	0,01	0,01	0,01	0,01
Repeatability	mm	0,005	0,005	0,005	0,005	0,005	0,005
<b>Drive capacity</b>							
Motor rating main drive max. / const.	kW	18 / 12	25 / 17	25 / 17	42 / 28	42 / 28	42 / 28
Motor rating X / Y axis	kW	2,1	4,3	4,3	7,7	7,7	7,7
Motor rating Z axis (brakes)	kW	4,3	5,2	5,2	7,7	7,7	7,7
<b>Measures and weights</b>							
Overall dimensions (length x width x height)	m	4,8x3,15x2,8	5,5x3,5x3,4	6,5x3,5x3,4	7,5x6,1x4	9,5x6,1x4	11,5x6,6x4
Weight	kg	20.000	31.000	33.000	44.000	55.000	70.000
Part No.		170043	170044	170045	170046	170047	170048

For complete information on the VECTOR M with Heidenhain TNC 620 control, please visit: [www.knuth.com](http://www.knuth.com)



- Available with Siemens or Heidenhain control
- Tapping without compensating chuck (rigid tapping)
- Extremely rigid table structure
- Powerful BT 40 spindle with speeds up to 10.000 rpm

### The compact versatile machining center with extensive reserve power

- The large VECTOR Series is perfectly equipped for large jobs and can be ordered with customized accessories to provide flexible solutions for constantly expanding requirements

### Machine Design

- The machine bed of the large VECTOR Series is significantly longer and wider than the bed of the more compact models and can handle table loads up to 1500 kg (VECTOR 1400)
- The extra-wide column base and large guide distances ensure the necessary rigidity for fast machining processes requiring high precision
- During the development of this series, modern FEM analysis tools were used for the simulation of countless load conditions in order to guarantee superior stability of the machine frame in real-world applications, which now exceeds all expectations for this class of machines
- All axes move on premium, fully enclosed linear roller guideways and precision ball screws and are driven by dynamic servo-motors

### Extra-rigidity at all the right places

- The VECTOR features larger guideways that are equipped with additional guide carriages for even higher load capacities, more rigidity and higher speeds during heavy-duty machining operations

### Spindle

- Clamping the tool between contact surfaces at the taper and workpiece flange ensures maximum hold of the tool in the spindle

### Tool changer

- With only 1.8 seconds tool changing time, the dual-arm gripper also is one of the fastest tool changers on the market

### Handling

- Electrical equipment is divided into separate control cabinets for high and low voltage systems, which results in a significant reduction of heat accumulation and noise
- An electronic hand-wheel simplifies machine set-up
- The automatic central lubrication system ensures proper lubrication of all lube points

### Control

- Siemens or Heidenhain controls are the perfect choice in regards to a future-proof investment in the most advanced machine tool electronics



The totally enclosed work space features a large door and side doors for easy access, safety and cleaning

## Standard Equipment

Siemens 828D control with Shopmill, coolant through spindle 30 bar with double filter, 24-station tool changer with dual-arm, BT 40 mount, spindle oil cooler, chain-type conveyor with chip container, electronic hand-wheel, oil skimmer, automatic central lubrication, coolant system flush gun, chip wash system, heat Exchanger for electric control cabinet, telescoping axis cover, RS-232 interface, USB port, CF card reader, totally enclosed work space, work lamp, 3-color signal lamp, coolant system, adjustable machine feet, operating tools, operator instructions

## Options

To see the available options for this machine, visit our website.

## Specifications Vector

		1300 M SI	1400 M SI
<b>Working area</b>			
Table dimensions	mm	1.400x700	1.500x700
Workpiece weight (max.)	kg	1.400	1.500
Spindle nose-to-table surface distance	mm	150 - 850	150 - 850
Number of T-slots	Pieces	6	6
T-slot (width x spacing)	mm	18x100	18x100
<b>Travels</b>			
Travel X-axis	mm	1.300	1.400
Travel Z-axis	mm	700	700
<b>Headstock</b>			
Spindle speed	1/min	10.000	10.000
Spindle mount		BT 40	BT 40
<b>Rapid feed</b>			
X-axis rapid feed	m/min	24	24
Y-axis rapid feed	m/min	24	24
Z-axis rapid feed	m/min	24	24
<b>Feed</b>			
Work feed X-axis	mm/min	0,1 - 10	0,1 - 10
Work feed Y-axis	mm/min	0,1 - 10	0,1 - 10
Work feed Z-axis	mm/min	0,1 - 10	0,1 - 10
<b>Tooling</b>			
Number of tool stations	Pieces	24	24
Tool size Ø x L (max.)	mm	80x300	80x300
Tool-changing time chip/chip	sec	3,9	3,9
Tool-change time tool/tool	sec	1,8	1,8
<b>Accuracies</b>			
Positioning accuracies	mm	0,005	0,005
Repeatability	mm	0,003	0,003
<b>Drive capacity</b>			
Main drive, continuous load	kW	17	17
Motor rating X-axis	kW	5,5	5,5
Motor rating for Y-axis drive	kW	5,5	5,5
Motor rating Z-axis	kW	5,5	5,5
<b>Measures and weights</b>			
Weight	kg	9.000	9.500
Overall dimensions (length x width x height)	m	3,4x2,6x3,3	3,8x2,6x3,3
Part No.		181342	181343

For complete information on the VECTOR M with Heidenhain TNC 620 control, please visit: [www.knuth.com](http://www.knuth.com)



- Available with Siemens or Heidenhain control
- Tapping without compensating chuck (rigid tapping)
- Quick-action tool changer
- Powerful BT 40 spindle with speeds up to 10.000 rpm



### The compact versatile machining center for large workpieces

#### Machine Design

- The innovative machine base design features a low center of gravity for excellent rigidity, allowing high-precision machining of workpieces with weights up to 1200 kg
- With extensive experience and modern FEM analysis tools for the simulation of countless load conditions, it was possible to guarantee superior stability of the machine frame in real-world applications
- One development goal was to achieve a space-saving, compact design
- Linear roller guides on all axes provide high load capacities, maximum rigidity and smooth motion ensuring the high dynamics needed to optimally handle high loads
- Powerful servo-drives connect directly to large preloaded ball screws providing zero-loss high torque transmission

#### Main spindle

- Main spindle runs on multiple bearings to ensure excellent absorption and dissipation of forces during machining
- The advanced design of our spindles ensure low heat accumulation under load
- Large pre-loaded bearings ensure radial stability during heavy-duty machining operations
- High-temperature lubricants ensure optimum lubrication at any operating temperature and a long tool life
- Clamping the tool between contact surfaces at the taper and workpiece flange ensures maximum hold of the tool in the spindle

## Tool changer

- The VECTOR is equipped with the best tool changer to allow full utilization of the machining center's capacity
- With only 1.8 seconds tool changing time, the dual-arm gripper also is one of the fastest tool changers on the market

## Handling

- The totally enclosed work space features a large door and side doors for easy access, safety and cleanliness
- Electrical equipment is divided into separate control cabinets for high and low voltage systems, which results in a significant reduction of heat accumulation and noise
- An electronic hand-wheel simplifies machine set-up
- The automatic central lubrication system ensures proper lubrication of all lube points

## Specifications

### VECTOR 1200 M SI

<b>Working area</b>		
Table dimensions	mm	1.300x600
T-slots (number/width/spacing)	mm	5x18x100
Spindle nose-to-table surface distance	mm	150 - 750
Spindle center-to-stand distance	mm	600
<b>Travels</b>		
Travel X-axis	mm	1.220
Travel Y-axis	mm	600
Travel Z-axis	mm	600
<b>Headstock</b>		
Spindle speed	1/min	10.000
Spindle mount		BT 40
<b>Rapid feed</b>		
X-axis rapid feed	m/min	36
Y-axis rapid feed	m/min	36
Z-axis rapid feed	m/min	36
<b>Feed</b>		
Work feed X-axis	mm/min	0,1 - 10
Work feed Y-axis	mm/min	0,1 - 10
Work feed Z-axis	mm/min	0,1 - 10
<b>Tooling</b>		
Number of tool stations	Pieces	24
Tool size Ø x L (max.)	mm	80x300
Tool weight max.	kg	7
Tool-changing time chip/chip	sec	3,9
Tool-change time tool/tool	sec	1,8
<b>Accuracies</b>		
Positioning accuracies	mm	0,005
Repeatabilities	mm	0,003
<b>Drive capacity</b>		
Main drive, continuous load	kW	12
Motor rating X-axis	kW	3,3
Motor rating Y-axis	kW	3,3
Motor rating Z-axis	kW	5,5
Total power consumption	kVA	13
<b>Measures and weights</b>		
Overall dimensions (length x width x height)	m	3x2,4x2,93
Weight	kg	6.500
Part No.		181340



## Control

- Siemens or Heidenhain controls are the perfect choice in regards to a future-proof investment in the most advanced machine tool electronics

## Standard Equipment

**control Siemens 828D with Shopmill**, coolant through spindle 30 bar with double filter, 24-station tool changer with dual-arm, BT 40 mount, spindle oil cooler, chain-type conveyor with chip container, electronic hand-wheel, oil skimmer, automatic central lubrication, coolant system flush gun, chip wash system, heat Exchanger for electric control cabinet, telescoping axis cover, RS-232 interface, USB port, CF card reader, totally enclosed work space, work lamp, 3-color signal lamp, coolant system, adjustable machine feet, operating tools, operator instructions

## Options

To see the available options for this machine, visit our website.

For complete information on the VECTOR M with Heidenhain TNC 620 control, please visit: [www.knuth.com](http://www.knuth.com)



Actual machine may vary slightly



See this machine  
in action on  
YouTube



- Available with Siemens or Heidenhain control
- Tapping without compensating chuck (rigid tapping)
- Quick-action tool changer
- Powerful BT 40 spindle with speeds up to 10.000 rpm

**Compact All-in-One machining center  
for powerful 3-axis machining**

### Highlights

- Powerful BT 40 spindle with speeds up to 10,000 rpm
- Rigid machine structure with extra deep center of gravity and small footprint
- Compact all-in-one machining center with a standard configuration for various applications, ideal for the cost-conscious user



- Dual-arm tool changer with 24 stations ensures adequate flexibility and capacity for every day production needs
- The Vector Series features linear guides on X, Y and Z to ensure high accuracy made possible by lower friction
- 30-Bar internal cooling for optimum machining quality

## Standard Equipment

control Siemens 828D with Shopmill, coolant through spindle 30 bar with double filter, 24-station tool changer with dual-arm, main spindle motor 9 kW, BT 40 mount, spindle oil cooler, chain-type conveyor with chip container, electronic hand-wheel, oil skimmer, automatic central lubrication, coolant system flush gun, chip wash system, heat Exchanger for electric control cabinet, telescoping axis cover, RS-232 interface, USB port, CF card reader, totally enclosed work space, work lamp, 3-color signal lamp, coolant system, adjustable machine feet, operating tools, operator instructions

## Options

## Part No.

• Chip Wash System	253384
• Spindle Oil Cooler	253440
• Direct Drive 10.000 rpm spindle, CTStype with hollow shaft motor	252818
• 4th axis DR-250H f. VECTOR with Motor/Amp, installed	252886
• Arm Type BT40 upg. from 24 to 30 tools	252967

For additional options for this machine, visit our website.

## Specifications VECTOR

		650 M SI	850 M SI	1000 M SI
<b>Working area</b>				
Table dimensions	mm	800x550	1.000x550	1.100x550
Table load capacity	kg	600	800	800
Spindle nose-to-table surface distance	mm	150 - 700	150 - 700	150 - 700
Spindle center - column	mm	520	520	520
<b>Travels</b>				
Travel X-axis	mm	650	850	1.000
Travel Y-axis	mm	550	550	550
Travel Z-axis	mm	550	550	550
Guideway		Roller		Roller
<b>Headstock</b>				
Spindle speed	1/min	10.000	10.000	10.000
Spindle mount		BT 40	BT 40	BT 40
Torque, constant	Nm	45	45	45
Spindle bearing		7012 x 4	7012 x 4	7012 x 4
Draw bolts		MAS407	MAS407	MAS407
<b>Rapid feed</b>				
Rapid feed X-/ Y-axis	mm/min	36.000	36.000	36.000
Rapid feed Z-axis	mm/min	15.000	15.000	15.000
<b>Feed</b>				
Work feed X-axis	mm/min	10.000	10.000	10.000
Work feed Y-axis	mm/min	10.000	10.000	10.000
Work feed Z-axis	mm/min	10.000	10.000	10.000
<b>Tooling</b>				
Tool changer type		Twin arm	Twin arm	Twin arm
Number of tool stations	Pieces	24	24	24
Tool selection		Memory random	Memory random	Memory random
Tool size Ø x L (max.)	mm	80x300	80x300	80x350
Tool weight max.	kg	7	7	7
Tool-change time tool/tool	sec	1,8	1,8	1,8
Tool-changing time chip/chip	sec	3,9	3,9	3,9
<b>Accuracies</b>				
Repeatability	mm	± 0,003	± 0,003	± 0,003
Positioning accuracy	mm	± 0,005	± 0,005	± 0,005
<b>Drive capacity</b>				
Main drive, continuous load	kW	9	9	9
Total power consumption	kVA	15	15	15
Voltage	V	400	400	400
Mains frequency	Hz	50	50	50
<b>Measures and weights</b>				
Overall dimensions (length x width x height)	m	2,42x2,2x2,7	2,42x2,2x2,7	2,62x2,2x2,7
Weight	kg	4.000	4.300	4.600
Part No.		181272	181271	181270



- Available with Siemens, Fanuc, or Heidenhain control
- Main motor rating up to 11 kW (Fanuc)
- Rotary swivel table with 200 mm table diameter
- BT 40 Spindle with up to 10.000 rpm

- The new X.mill series with rotary swivel table is the perfect tool for streamlined and cost-effective multi-axis machining
- A 4th and 5th machining axis brings additional competitive advantages due to shorter cycle times, better surface grades and dimensional stability
- The entire series is available with either a Siemens, Fanuc or Heidenhain control, so users can select the optimum control for their needs.

### Machine Design

- The X.mill series machine frame was developed using the most advanced FEM analysis software on the market.
- All axes move on premium linear guideways and precision ball screws with rigid covers to protect them from chips and coolant splashes

### Rotary Swivel Table

- A 4th and 5th machining axis complete the assembled rotary swivel table that features 200 mm diameter and a large swivel range
- The expansion by one rotary and swivel axis saves the operator steps and opens new possibilities for the cost-effective production of complex parts
- 3+2 axis milling brings the advantage that the application of CAM software and the possible cutting strategies conform to those of 3-axis programming, resulting in simplified programming and significantly reduced training requirements
- The compact design and high rigidity of the moving axes ensure long tool life and excellent surface quality



## Spindle

- The advanced design of our spindles ensure low heat accumulation under load
- Large pre-loaded bearings ensure radial stability during heavy-duty machining operations

## Tool changer

- The quick tool changer with dual-arm gripper and 24 stations provides plenty of capacity for every-day production operations

## Specifications

### X.mill 5X 1000 SI

Working area		
Table dimensions	mm	1.100x550
Table load capacity	kg	800
Center height, vertical	mm	245
Spindle axis-to-table surface distance	mm	150 - 700
Spindle axis-to-table surface distance with rotating swivel table	mm	40 - 640
Spindle center-to-stand distance	mm	520
Number of T-slots	Pieces	5
T-slot (width x spacing)	mm	18x100
Travels		
Travel X-axis	mm	1.000
Travel X-axis with rotating swivel table	mm	210
Travel Y-axis	mm	550
Travel Y-axis with rotating swivel table	mm	550
Travel Z-axis	mm	800
Travel Z-axis with rotating swivel table	mm	600
Headstock		
Spindle speed	1/min	10.000
Spindle mount		BT 40
Torque, constant	Nm	45
Rapid feed		
Rapid feed X-, Y-, Z- axis	mm/min	36.000
Feed		
Work feed X / Y / Z axis	m/min	10x10x10
Tooling		
Number of tool stations	Pieces	24
Tool Ø	mm	100 (130)
Tool weight max.	kg	8
Tool-changing time chip/chip	sec	3,9
Tool-change time tool/tool	sec	1,8
Rotary Swivel Table		
Table diameter	mm	200
Height of stop rod	mm	375
Bore	mm	35
Increment min.	deg	0,001
Swivel range	deg	-15 - 115
Workpiece weight -15 to 30 degrees	kg	100
Workpiece weight 31 to 115 degrees	kg	50
Drive capacity		
Motor rating main drive	kW	9
Motor rating X-axis	kW	2,3
Motor rating for Y-axis drive	kW	2,3
Motor rating Z-axis	kW	2,3
Measures and weights		
Overall dimensions (length x width x height)	m	2,62x2,2x2,7
Weight	kg	4.600
Part No.		181405

## Equipment

- The totally enclosed workspace features a large door and side doors for easy access, safety and cleanliness
- Electrical equipment is divided into separate control cabinets for high and low voltage systems, which results in a significant reduction of heat accumulation and noise
- An electronic hand-wheel simplifies machine set-up
- The automatic central lubrication system ensures proper lubrication of all lube points

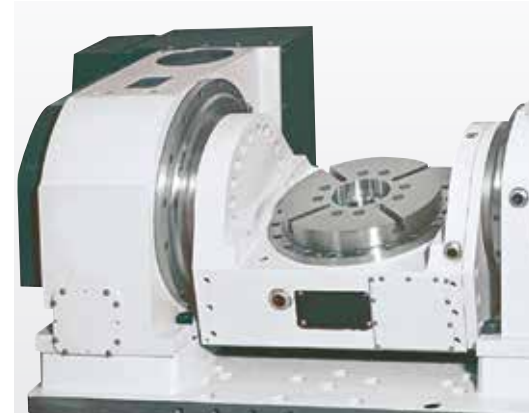

Rotary swivel table with a table diameter of 200 mm

## Standard Equipment

**Siemens 828D control**, BT40 24-station tool changer with dual-arm gripper, screw-type chip conveyor with bucket, rigid tapping, remote service for Siemens, autom. power off, manual coolant spray gun, coolant system, spindle air system, heat Exchanger for electric control cabinet, fully enclosed work space (without top cover), electronic hand-wheel, RS232 and RJ45 card interface, USB port, automatic central lubrication, work lamp, 3-color signal lamp, toolbox with tools, leveling bolts and blocks, 4th and 5th Axis Ø200 mm Rotary Table

## Options

### Part No.

• Upgrade Spindle Taper from BT40 to SK40	257404
• Upgrade Spindle Taper from BT40 to HSK63	253372
• Spindle speed upgrade 10.000 to 12.000 rpm (belt type)	253609

For additional options for this machine, visit our website.

**For complete information on the X.mill 5X 1000 with FANUC Oi MF (5) and Heidenhain TNC 620 controls, please visit:**  
[www.knuth.com](http://www.knuth.com)

For complete information on the X.mill T with Fanuc Oi MF (5) and Heidenhain TNC 620 controls, please visit: [www.knuth.com](http://www.knuth.com)



shown with Siemens control

- Available with Siemens, Fanuc, or Heidenhain control
- Tapping without compensating chuck (rigid tapping)
- Rigid table structure with very low center of gravity and small footprint
- Powerful BT 40 spindle with speeds up to 10.000 rpm



The guides in all axes are protected by robust stainless steel covers

- The new X.mill series is ideally suited for streamlined and cost-effective series production
- The entire series is available with either a Siemens, Fanuc or Heidenhain control, so users can select the optimum control for their needs

### Machine Design

- The X.mill series machine frame was developed using the most advanced FEM analysis software on the market
- The thorough analysis of the entire machine bed construction and wide column base resulted in a design that is optimized for all load conditions
- All axes move on premium, fully enclosed linear guideways and precision ball screws and are driven by dynamic servo-motors

## Spindle

- The main spindle is supported by multiple bearings to ensure excellent absorption and dissipation of forces during machining
- The advanced design of our spindles ensure low heat accumulation under load
- Large pre-loaded bearings ensure radial stability during heavy-duty machining operations
- High-temperature lubricants ensure optimum lubrication at any operating temperature and a long tool life

## Tool changer

- The robust armless 20-station tool changer brings flexibility to everyday production operations
- An optional 30-station tool changer with dual-arm gripper is also available

## Handling

- The totally enclosed workspace features a large door and side doors for easy access, safety and cleanliness
- An electronic hand-wheel simplifies machine set-up

- Electrical equipment is divided into separate control cabinets for high and low voltage systems, which results in a significant reduction of heat accumulation and noise
- The automatic central lubrication system ensures proper lubrication of all lube points

## Standard Equipment

**Siemens 828 D Basic control**, Umbrella type BT40 – 20 tools changer, USB port, rigid tapping, heat Exchanger for electric control cabinet, work lamp, automatic lubrication system, coolant system, manual coolant spray gun, autom. power off, electronic hand-wheel, screw-type chip conveyor with bucket, remote service for Siemens, spindle air system, fully enclosed workspace (except top cover), 3-color signal lamp, toolbox with tools, leveling bolts and blocks

## Specifications X.mill T

		700 SI	800 SI	1000 SI
<b>Working area</b>				
Table dimensions	mm	900x450	900x550	1.100x550
Table load capacity	kg	600	800	800
T-slots (number/width/spacing)	mm	5x18x80	5x18x80	5x18x100
Spindle axis-to-table surface distance	mm	110 - 660	110 - 660	150 - 700
Spindle center-to-stand distance	mm	520	520	520
<b>Travels</b>				
Travel X-axis	mm	700	800	1.000
Travel Y-axis	mm	450	520	550
Travel Z-axis	mm	550	550	550
<b>Headstock</b>				
Spindle speed	1/min	10.000	10.000	10.000
Spindle mount		BT 40	BT 40	BT 40
Torque, constant	Nm	45	45	45
<b>Rapid feed</b>				
Rapid feed X- / Y- / Z-axis	mm/min	36.000	36.000	36.000
<b>Feed</b>				
Work feed X- / Y- / Z-axis	m/min	10x10x10	10x10x10	10x10x10
<b>Tooling</b>				
Number of tool stations	Pieces	20	20	20
Tool Ø	mm	100 (130)	100 (130)	100 (130)
Tool weight max.	kg	8	8	8
Tool-change time tool/tool	sec	8	8	8
<b>Accuracies</b>				
Positioning accuracy	mm	0,005	0,005	0,005
Repeatability	mm	0,003	0,003	0,003
<b>Drive capacity</b>				
Motor rating main drive	kW	9	9	9
Motor rating for X-axis drive	kW	2,3	2,3	2,3
Motor rating for Y-axis drive	kW	2,3	2,3	2,3
Motor rating for Z-axis drive	kW	3,3	3,3	3,3
Total power consumption	kVA	15 - 20	15 - 20	15 - 20
<b>Measures and weights</b>				
Overall dimensions (length x width x height)	m	2,47x2,2x2,52	2,47x2,2x2,52	2,62x2,2x2,7
Weight	kg	4.200	4.400	4.600
Part No.		181400	181401	181402

## X.mill 400

Entry-level model for CNC milling, ideal for batch production and training purposes



See this machine  
in action on  
YouTube



- **BT-40 main spindle mount**
- **Spindle oil cooler is standard equipment**
- **Tapping without compensating chuck (rigid tapping)**

- Reliable, compact machining center with extensive equipment for streamlined, cost-effective series productions
- Massive cast-iron machine body integrates many years of experience and state-of-the-art technology
- All axes move on premium, fully enclosed linear guideways and precision ball screws and are driven by dynamic servo-motors
- The premium spindle unit features a large tool mount and a spindle oil cooler, which are of great advantage in continuous operations
- Fast rapid feeds and rugged horizontal tool changer allow for efficient machining with minimum downtime



Rugged horizontal tool changer with 12 stations



Siemens 808D Advance control

## Specifications

### X.mill 400

Working area			
Table dimensions	mm	600x300	
Table load capacity	kg	150	
T-slots (number/width/spacing)	mm	3x14x100	
Spindle nose-to-table surface distance	mm	100 - 580	
Travels			
Travel X-axis	mm	400	
Travel Y-axis	mm	230	
Travel Z-axis	mm	450	
Headstock			
Spindle speed	1/min	8.000	
Spindle mount		BT 40	
Feed			
Rapid feed X-axis	mm/min	12.000	
Rapid feed Y-axis	mm/min	12.000	
Rapid feed Z-axis	mm/min	10.000	
Work feed X / Y / Z axis	mm/min	1 - 10.000	
Tool Head			
Number of tool stations	Pieces	12	
Tool Ø	mm	50 (120)	
Tool length (max.)	mm	200	
Tool weight max.	kg	3	
Tool-change time tool/tool	sec	7	
Accuracies			
Positioning accuracies	mm	0,02	
Repeatabilities	mm	0,01	
Drive capacity			
Motor rating main drive	kW	3,7	
Motor rating for X-axis drive	kW	0,75	
Motor rating for Y-axis drive	kW	0,75	
Motor rating for Z-axis drive	kW	1	
Total power consumption	kVA	10	
Measures and weights			
Overall dimensions (length x width x height)	m	2,1x1,9x2,45	
Weight	kg	2.200	
Part No.		181359	

- The totally enclosed work space features a large door and side doors for easy access, safety and cleanliness
- Siemens 808D control: cost-effective, easy to handle, superior reliability backed by worldwide service
- electronic hand-wheel simplifies machine set-up
- The automatic central lubrication system ensures proper lubrication of all lube points

## Standard Equipment

Siemens 808D Advance control, 12-station automatic tool changer, electronic hand-wheel, coolant system, operational health status indicator, automatic central lubrication, enclosure, level pads and bolts, work lamp, compressed air gun, operating tools, operator manual

## Options

### Part No.

• Shell End Milling Arbor Ø40 BT 40	103928
• Milling Chuck WELDON BT 40 / Ø 32 mm	106828
• Collet Chuck MAS BT40-ER40-80	104206
• ER 40 Collet Set 15 pcs.	106054
• Keyless Drill Chuck 1-13 mm B 16	104765
• Keyless Drill Chuck 3-16 mm B 18	104770
• Assembly Stand	108930
• HNCS 100V Hydraulic Machine Vise	104930
• Clamping Tool Set Deluxe 14/M12	105295

For additional options for this machine, visit our website and search for X.mill 400 (Product Search)

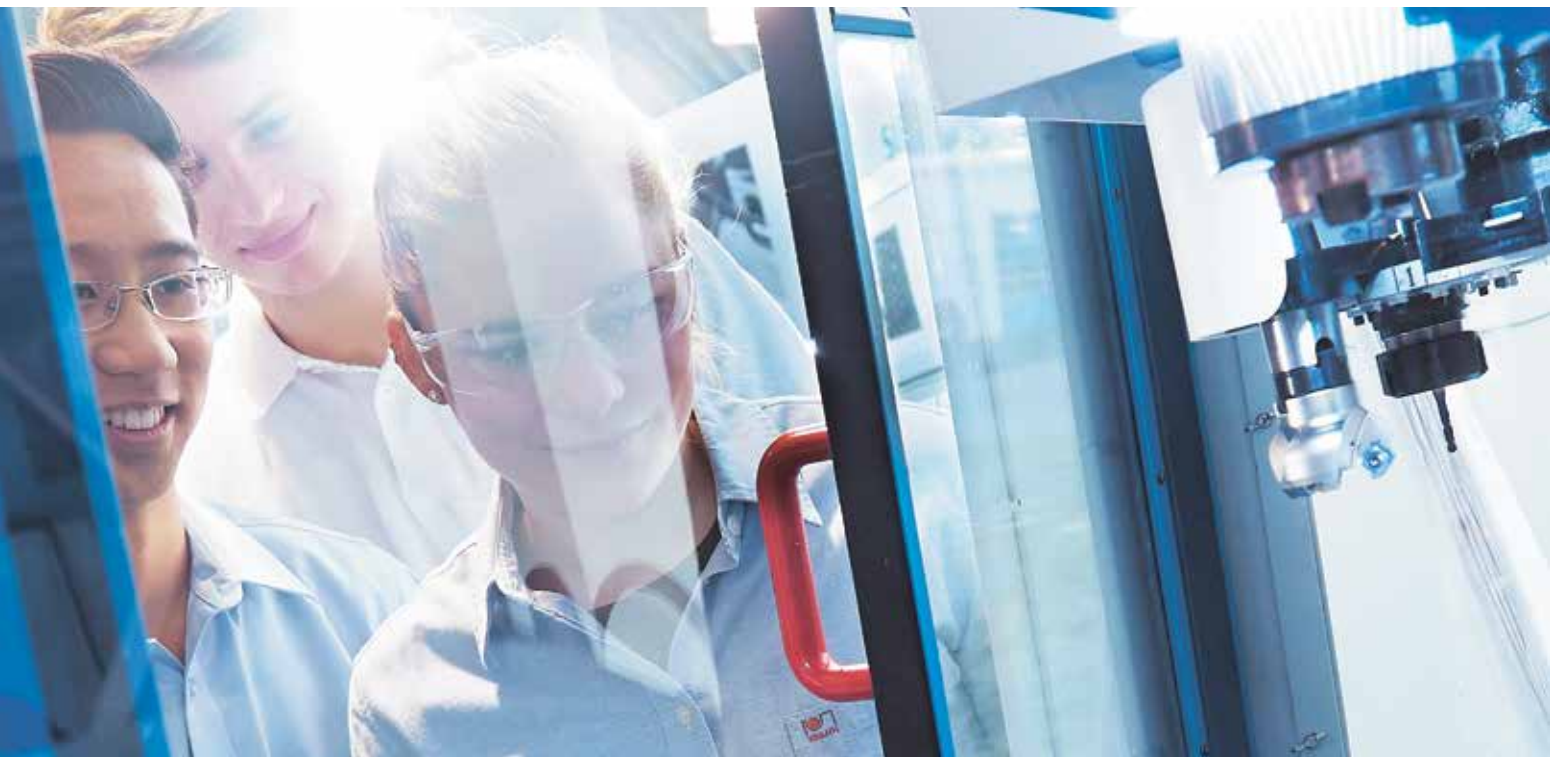

## Hands-on learning on KNUTH machines with Siemens controls for state certified and practical vocational training

Depending on requirements and training objective, KNUTH CNC machine tools can be used to implement the dual training concept that teaches theoretical content and deepens this knowledge with hands-on practical experience. This principle has been successfully used in continuous vocational training and employee training programs.

The programming instructions with the simulation software of the Siemens 808 control are ideal for CNC beginners, students and apprentices who have completed their training on conventional lathes and milling machines and have a basic knowledge of CNC machining. KNUTH machine tools have a proven track record of decades of successful use at schools and universities worldwide.

KNUTH offers an extensive portfolio for the basic turning and milling training package. The servo-conventional machines, Servoturn and Servomill, represent the new generation of conventional machining.

The Siemens SINUMERIK CNC Controls provide the perfect control solution for each of these machine designs. Compact and user-friendly, the 808D and 828D are ideally suited for basic turning and milling applications as well as standardized machine designs with high CNC performance.

## Theoretical and practical training - Be convinced

Take the first step and make yourself familiar with our new training concept. Don't hesitate to ask about a live meeting to learn about the machines, documentation and software.

A visit to our German headquarters in Wasbek provides you an ideal opportunity to gain insight and a complete picture of all aspects of the KNUTH Werkzeugmaschinen training initiative.

While you are there, don't miss the chance to visit the largest machine tool display in Northern Germany. Make your appointment today - we are looking forward to your visit.

Your KNUTH sales representative

## SMARTLAB Package

- **CNC Inclined-Bed Lathe**  
with automatic 4-station tool holder and tailstock
- **Vertical Machining Center**  
with automatic 4-station tool changer
- Siemens SINUMERIK 808D
- Detailed programming instructions



### THE MACHINES - Ideal for vocational training and continuous employee training

- The mobile CNC machines provide the full range of functionality
- Include automatic tool changers for a productive real-world training environment

### THE CONTROL - SINUMERIK 808D

#### The ideal entry-level CNC System

- Easy, intuitive user guidance, ideal for basic turning and milling applications
- High performance and precision

#### LabTurn 2028 - CNC Inclined-Bed Lathe

- Turning diameter over bed 200 mm
- Z-axis travel 155 mm
- 4-station tool turret
- Machine frame features a solid cast-iron inclined-bed construction ensuring excellent rigidity and chip removal
- High-precision linear guides guarantee high rigidity and accuracy
- Central lubrication
- 4-station tool turret with 4 tools for inside and outside machining
- 3-jaw chuck (100 mm) and rigid tailstock are included

#### LabCenter 260 - CNC Milling Machine

- Travels (X / Y / Z) – 251 x 152 x 168 mm
- Main spindle drive motor 1 kW
- 4-station tool changer
- Carefully machined frame with premium cast-iron construction
- Dovetail guides and preloaded ball screws with servo drives on all axes
- Max. spindle speeds up to 5000 rpm
- Electronic hand-wheel for efficient, professional set-up operations

#### Siemens Sinumerik 808D

- Self-explanatory, powerful control with a small footprint
- MDynamics for perfect milling operation
- Sinumerik 808D – included with standard equipment

Compact and robust with panel-based CNC design requiring minimal interfaces, and a resistant IP65 control panel make the SINUMERIK 808D the perfect control for dirty and harsh workshop environments. Additional features of the SINUMERIK 808D are low-profile chicklet key caps for effortless operation and the familiar SINUMERIK soft-key touch and feel.

The SINUMERIK 808D is optimized for turning and milling functions and its technology-specific features make it the perfect control for lathes and machining centers. The range of applications extends from basic standardized milling machines or simple machining centers to cycle lathes and full CNC lathes. Its MDynamics motion control ensures first class turning and milling results.

**Max. spindle speeds up to 5000 rpm**



**See this machine in action on YouTube**

- Dovetail guides and preloaded ball screws with servo drives on all axes
- Electronic hand-wheel for efficient and professional set-up
- 4-station tool changer ensures flexibility and optimum productivity

### Standard Equipment

Siemens 808D Advance control, electronic hand-wheel, 4-station tool changer, mobile base, central lubrication, work lamp, operating tools, operating manual and programming instructions

### Specifications

### LabCenter 260

Table dimensions	mm	400x145
Throat	mm	200
Travel X-axis	mm	260
Travel Y-axis	mm	152
Travel Z-axis	mm	180
Spindle speed	1/min	80 - 5.000
Spindle mount		ISO 20
Rapid feed X-axis	mm/min	2.000
Rapid feed Y-axis	mm/min	2.000
Rapid feed Z-axis	mm/min	2.000
Work feed	mm/min	500
Number of tool stations	Pieces	4
Motor rating main drive	kW	1
Overall dimensions (length x width x height)	m	1,4x0,9x1,8
Weight	kg	450
Part No.		181615



# LabTurn 2028

CNC turning with maximum precision and minimum space requirement



See this Machine in action on YouTube 



Inclined bed design optimizes work space and chip removal

- Rigid cast-iron inclined bed design ensures good stability and efficient chip removal
- Precision linear guides ensure high stability and accuracy
- 8-station tool turret with 4 tools per station for inside and outside turning

### Specifications

		LabTurn 2028
Workpiece length (max.)	mm	280
Turning diameter over bed	mm	200
Turning-Ø over support	mm	90
Speed range	1/min	100 - 3.000
Spindle mount		MK 3
Number of tool stations	Pieces	4
Motor rating main drive	kW	1
Weight	kg	360
Part No.		181625

### Options

	Part No.
• Turning Tool Set with 8 x 8 mm shank dimensions	251477
• Set of indexable inserts	251478
• E-Labturn 2028 spare parts package for 181625	259122

### Standard Equipment

Siemens 808D Advance control, electronic hand-wheel, 8-station turret, mobile base, tailstock, 3-jaw chuck Ø 100 mm, central lubrication, work lamp, operating tools, operating manual and programming instructions



Loading system with robot

## FlexLoader 10

Reach **1300 mm**

Load capacity **10 kg**

Let us automate your production.  
This perfectly designed system consists of  
frame, components and safety technology.

Page 74 / 75



Digitalization

## E.T. Box

4 LAN/WAN ports  
Input/Output 2xDi, 1xDo

With the E.T. Box you are always in  
control of your data!

Page 76 / 77

- Made in Germany
- Wide reach
- Grid plate as needed
- 12" Touchscreen
- TÜV certified safety



### The system comes complete with frame and safety technology.

- It features bulkheads on one side and is open on the operator side
- The enclosure can be selected as needed for left-hand or right-hand access
- The safety scanner is installed at the open side
- The system is provided with a pre-installed machine interface for various machine tools
- A pneumatic 2-finger gripper with adjustable pressure is pre-installed
- The standard version includes a grid plate. The plate size can be selected by the customer as needed for their workpiece dimensions.



2-jaw parallel gripper included in standard equipment



6-axis robot arm with a working radius of 1300 mm

## Specifications

## FlexLoader 10

Working area	
Load capacity	kg 10
Protection class	IP54
Working radius	mm 1.300
Base	
Grid plate (standard)	Work pieces 59
Max. part diameter (standard)	mm 40
2-finger gripper	
Strokes per jaw	mm 10
Gripping force – closing	N 885
Gripping force – opening	N 945
Closing time	sec 0,06
Opening time	sec 0,06
Assembled gripper jaw, max. intrinsic weight	kg 1,3
Max. length of gripper jaws	mm 160
Measures and weights	
Footprint (length x width)	mm 1.500x1.500
Weight	kg 400
Part No.	100128

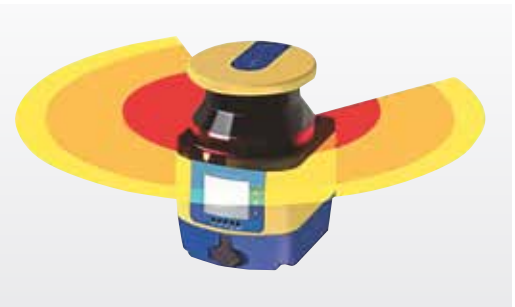

Safety laser scanner monitors work area

## Universal Robots UR10 (3rd generation)

- Load capacity: 10 kg
- Reach: 1300 mm
- Joint rotation: +/- 360° on all joints
- Speed: Joint: max. 120°/180°/sec ;  
Tool: about 1 m/sec
- Repeatability: +/- 0.1 mm
- IP Rating: IP54
- Includes an encoder and UR Safety 3.1 (8 adjustable safety functions) - with TÜV certification
- Communication: TCP/IP - Ethernet ports; Modbus, Profinet
- TCP programming: Graphical User Interface; 12" touchscreen

## Easy and flexible programming

- Flex HMI is a technology developed by Lorenscheit Automatisierungs-Technik. It features a PC-based user interface that is customized for the respective application and makes tooling of your robot a breeze. Many SMBs use their machines for small batch productions of 1 to 100 workpieces. At these quantities, work-intensive tooling would be counterproductive - tooling has to be simple and straightforward.

## Advantages

- High efficiency, consistent product quality and increased productivity
- Simplified operation during tooling of new workpieces
- Database for loading workpieces that have been set up previously (optionally with barcode scanner)
- Modular system design for easy expansion and maximum scalability
- Plug-and-Play connectivity based on pre-configured system consisting of HMI, robot and KNUTH FlexLoader
- For the KNUTH FlexLoader an automatic door is required at the machine. We provide retrofitting solutions upon request.

## Standard Equipment

Enclosure, safety technology, 2-finger gripper, grid plate, Flex-HMI with 12" touchscreen

## Easy remote service of CNC machines is now safer and easier than ever before.

- Secure VPN connection
- No additional software required
- No access to internal networks



The E.T. Box is a compact VPN router that can be mounted directly in the CNC machine's control cabinet. It provides external access to the machine's control via a LAN, WiFi or W4G connection.



- 4 configurable LAN/WAN ports
- Input/Output 2xDI, 1xDO
- Power supply 12-24 VDC+/-20%, LPS
- Temperature range from -25° to max. 60°C
- CE, UL, FCC, IC marks
- 36 month warranty

### Reduce down-time and cost!

- Your Advantage: If there is a problem, a KNUTH technician will remote into your machine's control within 4 hours and either solve the problem right then, or make targeted preparations for an on-site repair visit.
- This is made possible via Flexy 205® by Ewon®

### The E.T. Box will also give you new possibilities for doing more with your machine data!

- Global access to your machine's control
- Recall or display alarms
- Data management for workpieces / parts programs / offsets
- Integration in Smart Factory Systems

## Data Security

- Any access to the machine from outside must be verified by the operator via the HMI
- Secure VPN connection via internet: Talk2M Pro Server and infrastructure are hosted by internet providers with SSAE-16 and ISO 27001 certifications
- A key switch is provided to completely shut down the box, when no communication is needed
- No access to internal networks is possible, since connections are established via GSM. Optionally, connections via LAN or WIFI can be established
- **Save 10 % on all maintenance calls!**

**E.T. Box LAN Part No. 270307**

**E.T. Box WiFi Part No. 270308**

**E.T. Box W4G Part No. 270309**



Compact and space-saving router can be stored in the control cabinet of the machine

## Remote Service:

- Prompt support via remote service router. Specialized CNC technicians with comprehensive knowledge about your machine are available.
- Support for questions regarding machine operation, programming or the HMI user interface - the operator will get answers and live support while working at the machine.

## Advantages:

- In preparation for a pending machine maintenance call, the KNUTH CNC technician can gather information on the current machine status and initiate measures or order replacement parts.
- Diagnostics can be run not only per e-mail or phone, but also directly in the live-switched system
- Immediate analysis together with the operator or technician upon the occurrence of alarms or alert messages



The connected machine in production



KNUTH technicians can perform diagnostics directly on live system



## Advantages of the E.T. Box versus other technologies

- No extra software is necessary
- Easy setup at the machine
- No external hardware for data transfers is necessary (i. e., no PC must be provided during operation)

# Conventional turning machines

**See for yourself live:** Many models are in stock or can be viewed and tried out at a user's location near you. Make a demonstration appointment! [info@knuth.com](mailto:info@knuth.com)



## Experience our machines in action!

With our YouTube channel KNUTH Machine Tools, you stay up to date with all the news and developments.



### Heavy turning machine

#### DL S / DL E Heavy

Turning diameter **850 - 2.000 mm**  
Center width **1.500 - 8.000 mm**

High chip removal power,  
large clamping diameter  
and up to 10.000 kg  
workpiece weight

from page 84 onwards

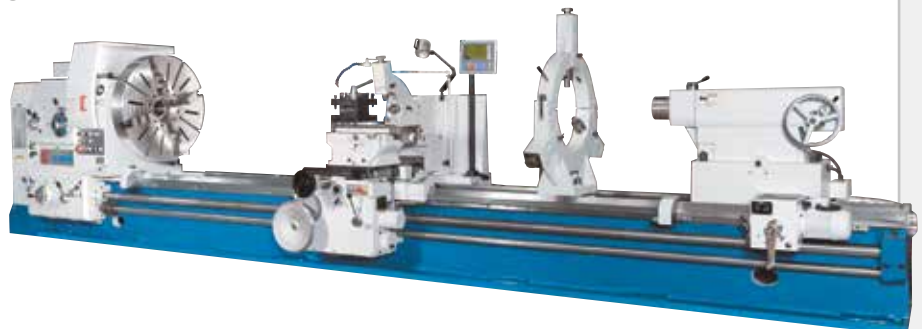

### Vertical turning machine

#### VDM S

Swing **800 - 2.600 mm**  
Machining height **800 - 1.500 mm**

The optimum solution  
for heavy workpieces

Page 80 / 81





Mechanic's turning machine

### Basic

Turning diameter **300 - 356 mm**

Center width **810 - 1.000 mm**

from page 100 onwards



Universal turning machine

### V-Turn PRO / V-Turn

Turning diameter **380 mm**

Center width **1.000 - 1.500 mm**

from page 96 onwards



Servo-conventional turning machine

### Servoturn®

Turning diameter **500 - 660 mm**

Center width **950 - 1.970 mm**

Page 88 / 89



Universal turning machine

### Turnado PRO / Turnado

Turning diameter **460 - 560 mm**

Center width **1.000 - 2.000 mm**

from page 92 onwards



Universal turning machine

### Sinus

Turning diameter **660 - 800 mm**

Center width **1.500 - 3.000 mm**

Page 90 / 91



Flat bed turning machine

### TubeTurn

Turning diameter **630 mm**

Workpiece length **1.300 mm**

Page 82 / 83



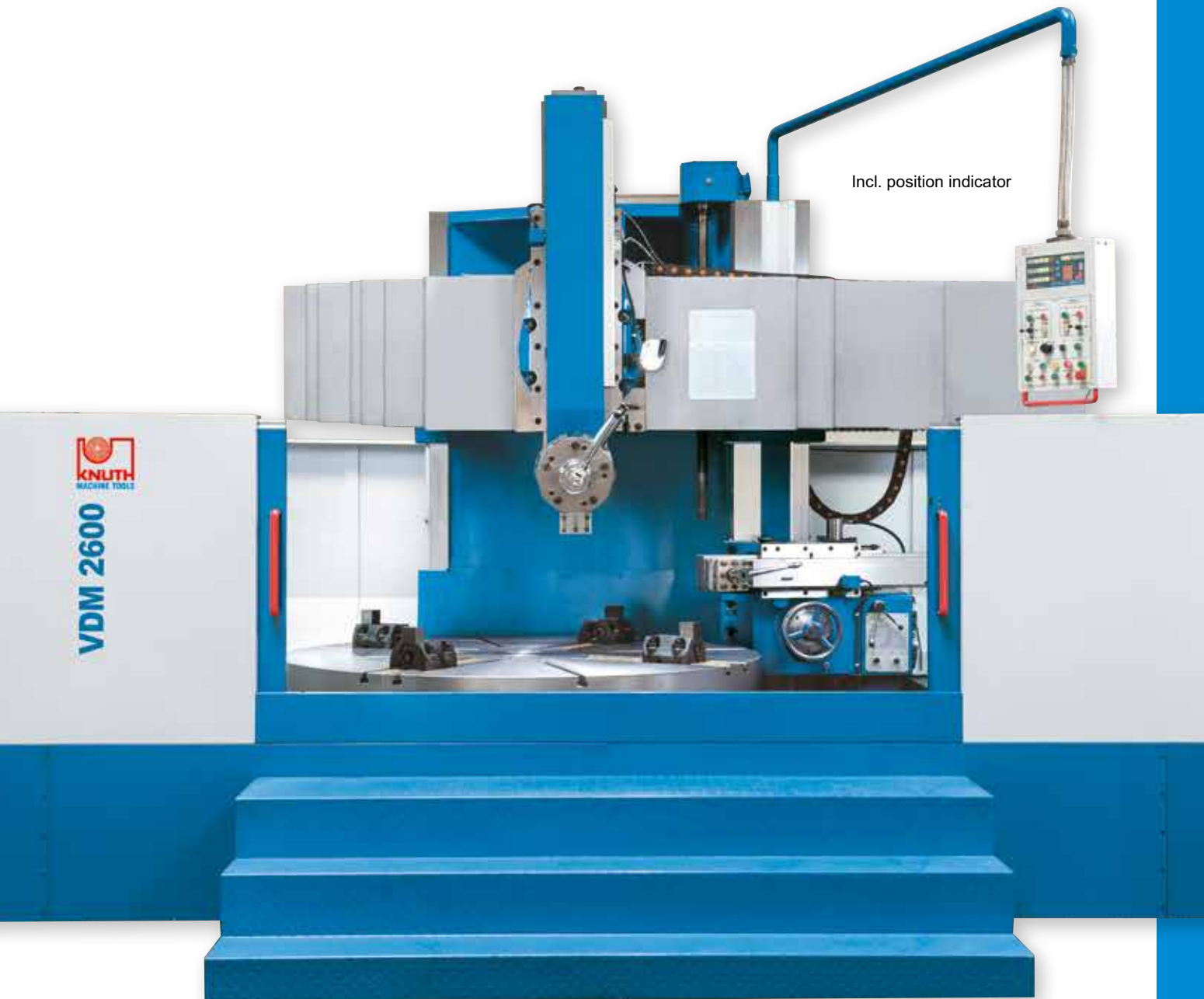

- Infinitely variable feed control via servo-motor
- Optimum tooling and easy access for cranes and forklift trucks
- Heavy-duty column with wide, hardened guideways
- hydraulic clamping of cross traverse
- Rigid guide construction ensures maximum rigidity and accuracy of the vertical boom
- Spindle runs in a high-precision two-row roller bearing and is adjustable
- reduction gear drive ensures high torque and a speed range of 10 - 315 rpm
- Servo motor technology ensures powerful, infinitely variable feed of the vertical boom



## Standard Equipment

3-axis position indicator, totally enclosed work space, chip conveyor, tool holder, vertical, tool holder, horizontal, automatic central lubrication, work lamp, anchor bolts, operating tools, operator manual

## Options

## Part No.

• Coolant System	251430
------------------	--------

Vertical support includes a 5-station tool holder, side support with independent feed for inside and outside turning

Specifications VDM		800 S	1000 S	1250 S	1600 S	2300 S	2600 S
<b>Working area</b>							
Rotating diameter (max.)	mm	800	1.000	1.250	1.600	2.300	2.600
Turning diameter of upper tool holder	mm	800	1.000	1.250	1.600	2.300	2.600
Turning diameter of side tool holder	mm	720	900	1.000	1.400	2.000	2.300
Machining height (max.)	mm	800	800	1.000	1.000	1.350	1.500
Swivel range of upper tool holder		± 30°	± 30°	± 30°	± 30°	± 30°	± 30°
Workpiece length (max.)	mm	800	800	1.000	1.000	1.350	1.500
Workpiece weight (max.)	kg	1.200	2.000	3.200	5.000	8.000	10.000
<b>Travels</b>							
Travel X1 axis, upper support	mm	570	670	700	915	1.150	1.300
Travel Z1 axis, upper support	mm	600	600	650	800	1.000	1.000
Travel W-axis, traverse	mm	580	580	650	650	1.000	1.100
Travel X2 axis, side support	mm	500	500	630	630	630	730
Travel Z2 axis, side support	mm	800	800	900	900	980	1.180
<b>Headstock</b>							
Speed range	1/min	(16) 10 - 315	(16) 8 - 250	(16) 6,3 - 200	(16) 5 - 160	(16) 3,2 - 100	(16) 1,4 - 45
Spindle Torque (max.)	Nm	10.000	12.500	17.500	25.000	32.000	32.000
Rotary table diameter	mm	720	900	1.000	1.400	2.000	2.300
<b>Feed</b>							
Velocity X / Z axis	mm/min	0,8 - 86	0,8 - 86	0,8 - 86	0,8 - 86	0,8 - 86	0,8 - 86
Feed speed W-axis	mm/min	440	440	440	440	440	440
Rapid feed of upper / side support	mm/min	1.800	1.800	1.800	1.800	1.800	1.800
Tool shank dimensions	mm	30x40	30x40	30x40	30x40	30x40	30x40
Tool weight (max.)	kg	50	50	50	50	50	50
<b>Drive capacity</b>							
Motor rating main drive	kW	22	22	22	30	37	37
Motor rating X / Z axis	kW	1,3 / 1,8	1,3 / 1,8	1,3 / 1,8	1,3 / 1,8	1,3 / 1,8	1,3 / 1,8
<b>Measures and weights</b>							
Overall dimensions (length x width x height)	m	4,9x3,5 x4,15	4,9x3,6 x4,15	5,3x3,8 x4,2	6,5x4,2 x4,4	7,6x5 x5,4	7,9x5,3 x5,4
Weight	kg	6.500	7.100	9.000	12.500	19.000	27.500
Part No.		301390	301391	301392	301393	301394	301396



### Extensive standard equipment

- **Spindle bore from 130 to 225 mm**
- heavy machine bed made of premium cast-iron with hardened and ground guideways
- massive headstock with high-precision spindle running in tapered roller bearings, and 2 lathe chuck mounts on both sides
- gears are hardened and ground
- high torque at the working spindle ensures high chip removal rates when machining parts with large diameters
- powerful main drive motor with 7,5 kW power
- central, practical controls for feeds and thread leads
- wide spectrum of inch and metric threads
- heavy-duty 4-station tool holder
- coolant system is included
- taper turning unit with 500 mm turning length



Spindle bores up to 225 mm



Taper turning unit is included

## Standard Equipment

3-axis position indicator, 4-station tool holder, two 3-jaw chuck 400 mm (TubeTurn 135), 3-jaw chuck Ø 500 mm (TubeTurn 200 and 225), 4-jaw face plate chuck Ø 520 mm (TubeTurn 200 and 225), taper turning unit, coolant system, operator manual

Options	Part No.
• external rest for TubeTurn - 301740	252874
• steady rest 320 mm for item 301739 - 301741	251055
• Quick-Change Tool Holder Set WC	103196

For additional options for this machine, visit our website and search for TubeTurn (Product Search)

The rear-mounted lathe chuck ensures increased stability for long workpieces



Specifications TubeTurn		135	200	225
<b>Working area</b>				
Workpiece length (max.)	mm	1.300	1.300	1.300
Turning diameter over bed	mm	630	630	630
Turning-Ø over support	mm	350	350	380
<b>Travels</b>				
Travel X-axis	mm	340	340	340
Travel Z-axis	mm	1.300	1.300	1.300
<b>Headstock</b>				
Speed range	1/min	14 - 496	24 - 300	24 - 300
Spindle torque (max.)	Nm	1.920	2.050	1.920
Lathe chuck diameter	mm	400	500	500
Spindle bore	mm	130	200	225
Spindle bore in chuck	mm	130	200	225
<b>Rapid feed</b>				
Rapid feed X-axis	mm/min	3.000	3.000	3.000
Rapid feed Z-axis	mm/min	4.000	4.000	4.000
<b>Feed</b>				
Feed X-axis	mm/R	(22) 0,02 - 0,45	(22) 0,02 - 0,45	(22) 0,02 - 0,45
Feed Z-axis	mm/R	(26) 0,07 - 133	(26) 0,07 - 133	(26) 0,07 - 133
<b>Tooling</b>				
Number of tool stations	Pieces	4	4	4
Tool shank dimensions	mm	32x32	32x32	32x32
<b>Tapping</b>				
Tapping, metric	mm	(24) 1 - 14	(24) 1 - 14	(24) 1 - 14
Tapping, whithworth	TPI	(40) 2 - 48	(40) 2 - 48	(40) 2 - 48
<b>Tailstock</b>				
Tailstock quill diameter	mm	100	100	100
Tailstock taper	MT	5	5	5
Tailstock quill stroke	mm	205	230	230
<b>Drive capacity</b>				
Motor rating main drive	kW	7,5	7,5	7,5
Total power consumption	kVA	8,5	9	9
<b>Measures and weights</b>				
Overall dimensions (length x width x height)	m	3,66x1,45x1,39	3,66x1,45x1,39	3,66x1,45x1,41
Weight	kg	4.100	4.190	4.264
Part No.		301739	301740	301741

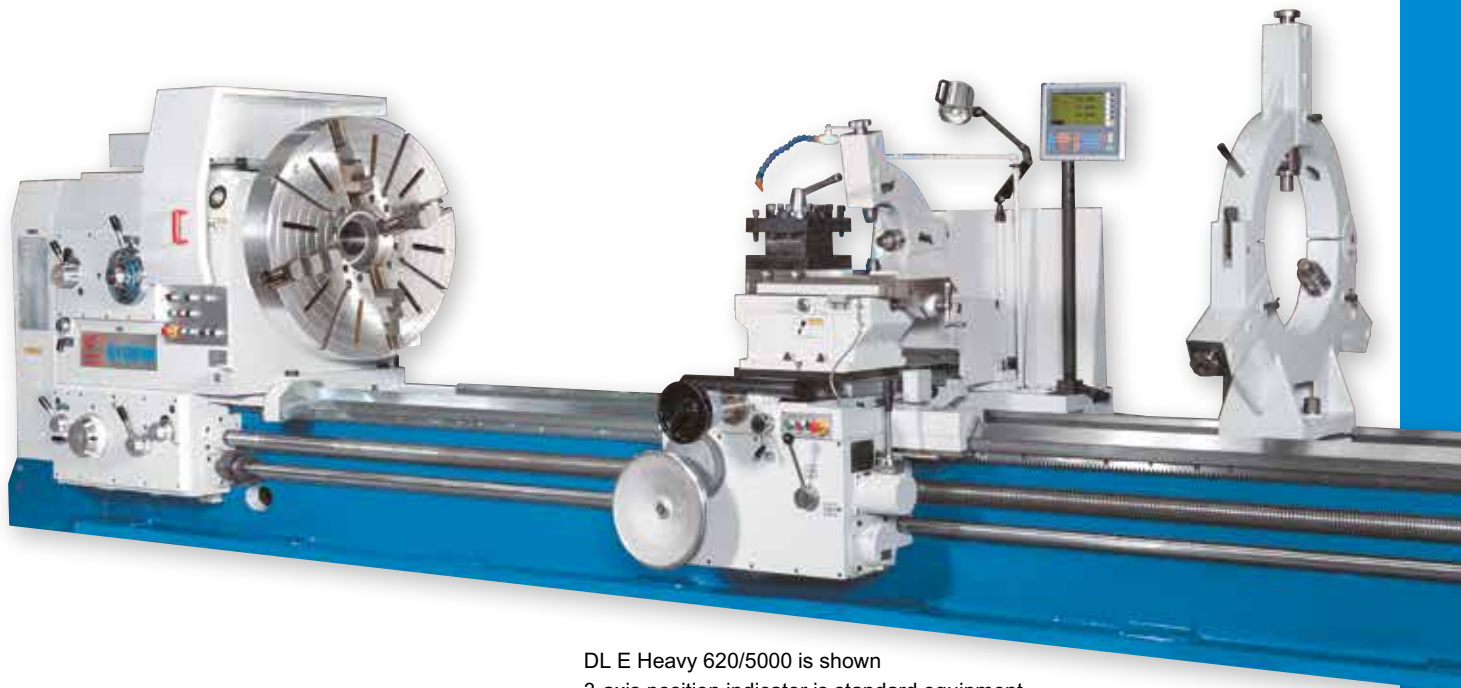

DL E Heavy 620/5000 is shown  
3-axis position indicator is standard equipment

Specifications DL E Heavy		500/1500	500/3000	500/5000	500/8000	620/1500	620/3000	620/5000	620/8000
<b>Working area</b>									
Workpiece length (max.)	mm	1.500	3.000	5.000	8.000	1.500	3.000	5.000	8.000
Turning diameter over bed	mm	1.000	1.000	1.000	1.000	1.250	1.250	1.250	1.250
Turning-Ø over support	mm	650	650	650	650	900	900	900	900
<b>Travels</b>									
Travel Z-axis	mm	1.300	2.800	4.800	7.800	1.300	2.800	4.800	7.800
Travel Z1-axis	mm	300	300	300	300	300	300	300	300
<b>Headstock</b>									
Spindle speeds (right)	1/min	(21) 3,15 - 315	(21) 3,15 - 315	(21) 3,15 - 315	(21) 3,15 - 315	(21) 3,15 - 315	(21) 3,15 - 315	(21) 3,15 - 315	(21) 3,15 - 315
Spindle bore	mm	130	130	130	130	130	130	130	130
Spindle mount		ISO A2-15	ISO A2-15	ISO A2-15	ISO A2-15	ISO A2-15	ISO A2-15	ISO A2-15	ISO A2-15
<b>Rapid feed</b>									
Rapid feed Z-axis	mm/min	3.740	3.740	3.740	3.740	3.740	3.740	3.740	3.740
<b>Feed</b>									
Feed X-axis	mm/R	0,064 - 12	0,064 - 12	0,064 - 12	0,064 - 12	0,064 - 12	0,064 - 12	0,064 - 12	0,064 - 12
Feed Z-axis	mm/R	0,032 - 6	0,032 - 6	0,032 - 6	0,032 - 6	0,032 - 6	0,032 - 6	0,032 - 6	0,032 - 6
<b>Tapping</b>									
Tapping, metric	mm	(45) 1 - 120	(45) 1 - 120	(45) 1 - 120	(45) 1 - 120	(45) 1 - 120	(45) 1 - 120	(45) 1 - 120	(45) 1 - 120
Tapping, diametric	DP	(42) 30-1/4	(42) 30 - 1/4	(42) 30 - 1/4	(42) 30 - 1/4	(42) 30 - 1/4	(42) 30 - 1/4	(42) 30 - 1/4	(42) 30 - 1/4
Tapping, module	mm	(46) 0,5 - 60	(46) 0,5 - 60	(46) 0,5 - 60	(46) 0,5 - 60	(46) 0,5 - 60	(46) 0,5 - 60	(46) 0,5 - 60	(46) 0,5 - 60
Tapping, whitworth	TPI	(48) 0,5-60	(48) 0,5 - 60	(48) 0,5 - 60	(48) 0,5 - 60	(48) 0,5 - 60	(48) 0,5 - 60	(48) 0,5 - 60	(48) 0,5 - 60
<b>Tailstock</b>									
Tailstock quill taper		metric 80	metric 80	metric 80	metric 80	metric 80	metric 80	metric 80	metric 80
Tailstock quill stroke	mm	300	300	300	300	300	300	300	300
<b>Drive capacity</b>									
Motor rating main drive	kW	22	22	22	22	22	22	22	22
<b>Measures and weights</b>									
Overall dimensions (length x width x height)	m	4,6x1,85x1,79	6,1x1,81x1,79	8,1x1,81x1,79	11,1x1,81x1,79	4,6x1,81x1,79	6,1x1,88x1,92	8,1x1,88x1,92	11,1x1,88x1,92
Weight	kg	9.350	10.850	12.650	16.100	9.750	11.550	13.300	16.800
Part No.		300499	300500	300502	300504	300505	300506	300508	300510

## Options

To see the available options for this machine, visit our website.

- 22 kW motor ensures high cutting power
- heavy-duty cast-iron body with ribbed bed reduces vibrations to a minimum
- induction hardened and ground guideways
- sturdy multi-disk clutch for headstock drive
- separate rapid feed motor for feed in X and Z direction
- Joystick control for X and Z feeds is mounted directly to support
- Motorized positioning of tailstock (all models with a minimum center width of 3000 mm)

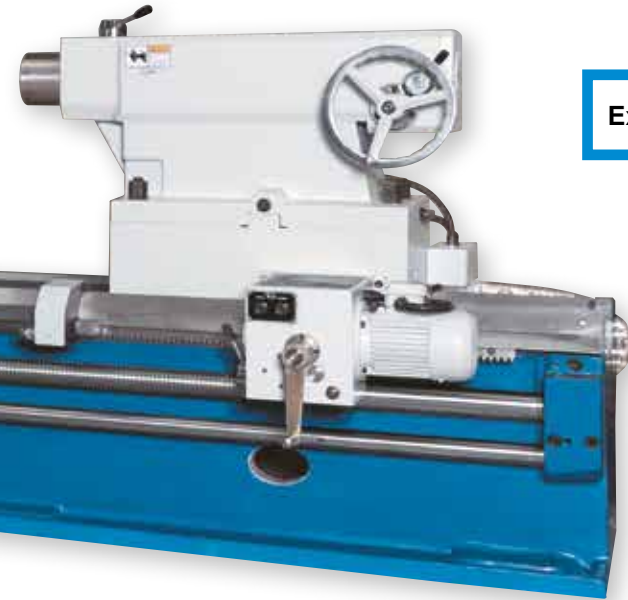

### Extensive standard equipment

#### Standard Equipment:

3-axis position indicator, 4-jaw independent chuck (DL E 500 and 620 series  $\varnothing = 1000$  mm, DL E 800 series  $\varnothing = 1400$  mm, DL E 1000 series  $\varnothing = 1600$  mm), coolant system, steady rest (DL E 500 series 50 - 470 mm, DL E 620 series 50 - 590 mm, DL E 800 and 1000 series 220 - 630 mm), follow rest 50 - 220 mm (except DL E 800 and 1000 series), motorized tailstock (all models with a minimum center width of 3000 mm), LED work lamp, centers, reducing sleeves, foundation bolts, central lubrication, operating tools, operator manual

Specifications DL E Heavy		800/3000	800/5000	800/8000	1000/2000	1000/3000	1000/5000	1000/8000
<b>Working area</b>								
Workpiece length (max.)	mm	3.000	5.000	8.000	2.000	3.000	5.000	8.000
Turning diameter over bed	mm	1.600	1.600	1.600	2.000	2.000	2.000	2.000
Turning- $\varnothing$ over support	mm	1.280	1.280	1.280	1.600	1.600	1.600	1.600
<b>Travels</b>								
Travel Z-axis	mm	2.800	4.800	7.800	1.800	2.800	4.800	7.800
Travel Z1-axis	mm	200	200	200	200	200	200	200
<b>Headstock</b>								
Spindle speeds (right)	1/min	(21) 2,5 - 250	(21) 2,5 - 250	(21) 2,5 - 250	(21) 2 - 200	(21) 2 - 200	(21) 2 - 200	(21) 2 - 200
Spindle bore	mm	130	130	130	130	130	130	130
Spindle mount		ISO A2-15	ISO A2-15	ISO A2-15		ISO A2-15	ISO A2-15	ISO A2-15
<b>Rapid feed</b>								
Rapid feed Z-axis	mm/min	3.740	3.740	3.740	3.740	3.740	3.740	3.740
<b>Feed</b>								
Feed X-axis	mm/R	0,064 - 12	0,064 - 12	0,064 - 12	0,064 - 12	0,064 - 12	0,064 - 12	0,064 - 12
Feed Z-axis	mm/R	0,032 - 6	0,032 - 6	0,032 - 6	0,032 - 6	0,032 - 6	0,032 - 6	0,032 - 6
<b>Tapping</b>								
Tapping, metric	mm	(45) 1 - 120	(45) 1 - 120	(45) 1 - 120	(45) 1 - 120	(45) 1 - 120	(45) 1 - 120	(45) 1 - 120
Tapping, diametric	DP	(42) 30 - 1/4	(42) 30 - 1/4	(42) 30 - 1/4	(42) 30 - 1/4	(42) 30 - 1/4	(42) 30 - 1/4	(42) 30 - 1/4
Tapping, module	mm	(46) 0,5 - 60	(46) 0,5 - 60	(46) 0,5 - 60	(46) 0,5 - 60	(46) 0,5 - 60	(46) 0,5 - 60	(46) 0,5 - 60
Tapping, whitworth	TPI	(48) 0,5 - 60	(48) 0,5 - 60	(48) 0,5 - 60	(48) 0,5 - 60	(48) 0,5 - 60	(48) 0,5 - 60	(48) 0,5 - 60
<b>Tailstock</b>								
Tailstock quill taper		metric 80	metric 80	metric 80	metric 80	metric 80	metric 80	metric 80
Tailstock quill stroke	mm	300	300	300	300	300	300	300
<b>Drive capacity</b>								
Motor rating main drive	kW	22	22	22	30	30	30	30
<b>Measures and weights</b>								
Overall dimensions (length x width x height)	m	6,04x2,06x2,23	8,04x2,06x2,23	11,04x2,06x2,23	5,2x2,2x2,4	6,1x2,2x2,4	8,1x2,2x2,4	12,92x2,38x2,51
Weight	kg	12.900	16.200	21.020	13.000	18.500	23.200	30.080
Part No.		300512	300514	300516	300518	300519	300520	300522



**Extensive standard equipment**

Specifications DL S		425/1500	425/3000	425/4000	425/5000	515/1500	515/3000	515/4000	515/5000
<b>Working area</b>									
Workpiece length (max.)	mm	1.500	3.000	4.000	5.000	1.500	3.000	4.000	5.000
Turning diameter over bed	mm	850	850	850	850	1.000	1.000	1.000	1.000
Turning-Ø over support	mm	520	520	520	520	720	720	720	720
Turning diameter over gap bridge	mm	1.150	1.150	1.150	1.150	1.350	1.350	1.350	1.350
Workpiece weight (max.)	kg	4.000	4.000	4.000	4.000	4.000	4.000	4.000	4.000
Gap bridge length	mm	470	470	470	470	470	470	470	470
Bed width	mm	600	600	600	600	600	600	600	600
<b>Travels</b>									
Travel X-axis	mm	550	550	550	550	550	550	550	550
Travel Z-axis	mm	1.380	2.800	3.800	4.800	1.380	2.800	3.800	4.800
Travel Z1-axis	mm	250	250	250	250	250	250	250	250
Swing range of top slide		90°	90°	90°	90°	90°	90°	90°	90°
<b>Headstock</b>									
Spindle speed	1/min	5 - 630	5 - 630	5 - 630	5 - 630	5 - 630	5 - 630	5 - 630	5 - 630
Spindle bore	mm	100	100	100	100	100	100	100	100
Spindle mount		A2-11	A2-11	A2-11	A2-11	A2-11	A2-11	A2-11	A2-11
<b>Rapid feed</b>									
Rapid feed X-axis	mm/min	1.800	1.800	1.800	1.800	1.800	1.800	1.800	1.800
Rapid feed Z-axis	mm/min	3.640	3.640	3.640	3.640	3.640	3.640	3.640	3.640
<b>Feed</b>									
Feed speed X-axis	mm/min	(64) 0,04-4,8	(64) 0,04-4,8	(64) 0,04-4,8	(64) 0,04-4,8	(64) 0,04-4,8	(64) 0,04-4,8	(64) 0,04-4,8	(64) 0,04-4,8
Feed speed Z-axis	mm/min	(64) 0,08-9,6	(64) 0,08-9,6	(64) 0,08-9,6	(64) 0,08-9,6	(64) 0,08-9,6	(64) 0,08-9,6	(64) 0,08-9,6	(64) 0,08-9,6
Feed speed Z1-axis	mm/min	(64) 0,02-2,4	(64) 0,02-2,4	(64) 0,02-2,4	(64) 0,02-2,4	(64) 0,02-2,4	(64) 0,02-2,4	(64) 0,02-2,4	(64) 0,02-2,4



- Extra heavy, wide machine bed with heavy ribbing and one-piece mono-block construction
- Induction-hardened and ground guide slots ensure long-term accuracy and minimum wear
- Massive headstock with high-precision main spindle on a tapered roller bearing with 100 mm spindle bore for excellent stability under heavy loads
- very quiet operation at maximum spindle speed
- All guideways are generously sized and gears are hardened and ground

- Joystick control for X and Z feeds is mounted directly to support
- Manual 4-step auxiliary gearbox, premium frequency drive technology combined with main spindle motor ratings up to 18.5 kW allow exact tuning of speed and torque for heavy-duty machining
- Rapid feed for X and Z axis allow quick support positioning and less down-time
- Adjustable overload clutch in apron protects the feed mechanics from damages and failures



### Standard Equipment

3-axis position indicator, 4-jaw faceplate chuck Ø 800 mm (DL S 425), 4-jaw faceplate chuck Ø 1000 mm (DL S 515), 4-station tool holder, steady rest 40-350 mm (except 425/1500 S and 515/1500 S), follow rest 30-120 mm (except 425/1500 S and 515/1500 S), dead centers, reducing sleeve, chuck guard, protective shield for support, coolant system, foundation bolts, work lamp, operating tools, operator instructions

Options	Part No.
• 3-jaw chuck (500 mm)	251158
• Motorized tailstock movement	251157
• Rest (100 - 520 mm)	251156
• Rest (300 - 720 mm)	251160
• Motorized tailstock movement	251161
• 3-jaw chuck (500 mm)	251162
• Coolant Concentrate 5 Ltr.	103184
• E-DL 425/515-1500/3000/4000/5000 S spare part package	259207

Specifications DL S		425/1500	425/3000	425/4000	425/5000	515/1500	515/3000	515/4000	515/5000
<b>Tooling</b>									
Tool shank dimensions	mm	32x32	32x32	32x32	32x32	32x32	32x32	32x32	32x32
<b>Tapping</b>									
Tapping, metric	mm	(56) 1-120	(56) 1-120	(56) 1-120	(56) 1-120	(56) 1-120	(56) 1-120	(56) 1-120	(56) 1-120
Tapping - inch		(56) 30 - 1/4	(56) 30 - 1/4	(56) 30 - 1/4	(56) 30 - 1/4	(56) 30 - 1/4	(56) 30 - 1/4	(56) 30 - 1/4	(56) 30 - 1/4
Tapping, diametric	DP	(56) 60-0,5	(56) 60-0,5	(56) 60-0,5	(56) 60-0,5	(56) 60-0,5	(56) 60-0,5	(56) 60-0,5	(56) 60-0,5
Tapping, module	mm	(56) 0,5 - 60	(56) 0,5 - 60	(56) 0,5 - 60	(56) 0,5 - 60	(56) 0,5 - 60	(56) 0,5 - 60	(56) 0,5 - 60	(56) 0,5 - 60
<b>Tailstock</b>									
Tailstock quill diameter	mm	120	120	120	120	120	120	120	120
Tailstock taper	MT	6	6	6	6	6	6	6	6
Tailstock quill stroke	mm	250	250	250	250	250	250	250	250
<b>Drive capacity</b>									
Motor rating main drive	kW	15	15	15	15	18,5	18,5	18,5	18,5
Motor rating coolant pump	kW	0,15	0,15	0,15	0,15	0,15	0,15	0,15	0,15
Motor rating feed	kW	1,1	1,1	1,1	1,1	1,1	1,1	1,1	1,1
Total power consumption	kVA	20	20	20	20	23	23	23	23
Supply voltage	V	400	400	400	400	400	400	400	400
<b>Measures and weights</b>									
Overall dimensions	m	3,65x1,5x1,5	5,15x1,5x1,5	6,15x1,5x1,5	7,15x1,5x1,5	3,65x1,5x1,6	5,15x1,5x1,6	6,15x1,5x1,6	7,15x1,5x1,6
Weight	kg	5.600	5.900	6.800	8.300	5.600	6.800	8.400	9.500
Part No.		301510	301511	301512	301513	301514	301515	301516	301517



- Preloaded ball screws on all axes
- Servo-motor instead of feed gears
- Electronic hand-wheels
- V-constant cutting speed

- The combination of a tried and tested machine base with the most advanced feed technology makes the change to a servo-conventional lathe even more attractive and cost-effective

**Intuitive operation as we know it from conventional machines - only much better:**

- feed and thread leads can be selected via rotary switch - what a brilliant concept
- Stops can be set electronically with the push of a button
- Feeds are infinitely variable between 50 and 100% via override potentiometer - finally available on a conventional lathe
- axes are powered by high-quality servo drives that translate your hand movements with the precision and dynamics of modern CNC machines
- infinitely variable speed adjustment and constant cutting speed of headstock
- Constant cutting speed: During face turning, the spindle speed automatically adapts to the changing workpiece diameter – the constant cutting speed at the cutting edge of the turning tool ensures superior turning results with quality comparable to CNC lathes

**Machine Frame**

- Heavy ribbed machine bed with wide, hardened bed guides and V-blocks allow for heavy-duty machining
- Headstock and main spindle are designed for optimum rigidity, vibration damping and temperature balance
- This entire series also features large spindle bores
- A quick-action tool changer is included in the standard package and ensures maximum flexibility and productivity

**Feed**

- Ball screws on the X- and Z-axes ensure considerably fewer errors due to looseness (backlash), resulting in significantly higher precision

**Equipment**

- The low-maintenance machine is equipped with a central lubrication system
- The heavy-duty tailstock is easy to handle and features high clamping force
- incl. 3-axis position indicator with integrated spindle speed display, fully assembled



## Standard Equipment

3-axis position indicator, 3-jaw chuck, work lamp, operating tools, operator instructions, steady rest, coolant system, protective shield for support, quick change tool holder, follow rest, electronic hand-wheels, fixed splash guard (wall)

Options	Part No.
• Power Worker Metal Cutter	123040
• Oscillation Element LK 3	103330

For additional options for this machine, visit our website.

Operation via electronic handwheels in the  $\mu$  range - in feel and position as with a conventional machine

Specifications Servoturn®		500/1000	500/1500	500/2000	660/1500	660/2000
<b>Working area</b>						
Center width	mm	950	1.450	1.950	1.470	1.970
Turning diameter over bed	mm	500	500	500	660	660
Turning- $\varnothing$ over support	mm	300	300	300	450	450
Bed width	mm	400	400	400	400	400
<b>Travels</b>						
Travel X-axis	mm	250	250	250	370	370
Travel Z-axis	mm	880	1.380	1.880	1.420	1.900
Travel Z1-axis	mm	100	100	100	100	100
<b>Headstock</b>						
Spindle speed	1/min	30 - 1600	30 - 1600	30 - 1600	30 - 1600	30 - 1600
Spindle bore	mm	86	86	86	86	86
Spindle mount		A2-8	A2-8	A2-8	A2-8	A2-8
Lathe chuck diameter	mm	250	250	250	315	315
<b>Rapid feed</b>						
X-axis rapid feed	m/min	4	4	4	4	4
Z-axis rapid feed	m/min	4	4	4	4	4
<b>Feed</b>						
Feed X-axis	mm/R	0,01 - 2	0,01 - 2	0,01 - 2	0,01 - 2	0,01 - 2
Feed Z-axis	mm/R	0,01 - 2	0,01 - 2	0,01 - 2	0,01 - 2	0,01 - 2
<b>Tapping</b>						
Tapping, metric	mm	0,35 - 14	0,35 - 14	0,35 - 14	0,35 - 14	0,35 - 14
Tapping, whithworth	TPI	48-4	48-4	48-4	48-4	48-4
<b>Tailstock</b>						
Tailstock quill diameter	mm	75	75	75	75	75
Tailstock taper	MT	5	5	5	5	5
Tailstock quill stroke	mm	150	150	150	150	150
<b>Drive capacity</b>						
Motor rating main drive	kW	6 - 9	6 - 9	6 - 9	7,5 - 11	7,5 - 11
Motor rating X-axis	kW	1,5	1,5	1,5	1,5	1,5
Motor rating Z-axis	kW	2,3	2,3	2,3	2,3	2,9
<b>Measures and weights</b>						
Overall dimensions (length x width x height)	m	3,2x1,28x1,65	3,75x1,28x1,65	4,25x1,28x1,65	3,74x1,6x1,65	4,23x1,6x1,75
Weight	kg	2.850	3.150	3.450	3.450	3.850
Part No.		300831	300832	300833	300834	300835

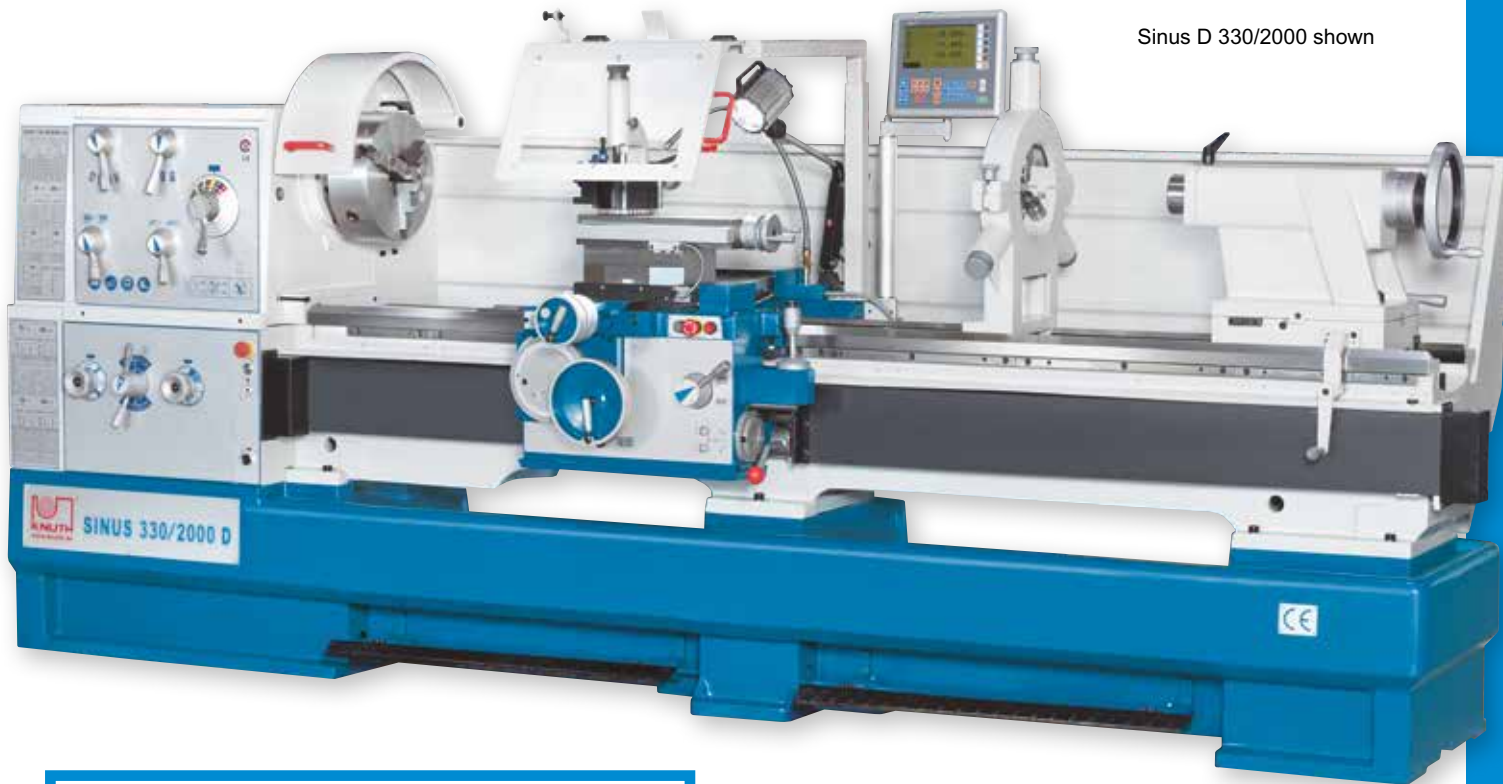

Sinus D 330/2000 shown

- Extensive standard equipment
- Total price includes 3-axis position indicator (assembled)



Experience our machines in action!



- removable bridge (250 mm) for machining of large parts with diameters up to 1035 mm
- high accuracy and low-noise operation even at high cutting power
- heavy and large bed
- hardened guideways (>HB 400)
- 105 mm spindle capacity for machining of large parts
- manual central lubrication
- automatic lubrication of headstock and main drive
- protected leadscrew
- overload protection for feed shaft and leadscrew
- support moves in linear and cross directions via rapid feed



Rests ensure maximum precision when machining long workpieces



## Standard Equipment

3-axis position indicator, 3-jaw chuck Ø 320 mm, 4-jaw face plate chuck Ø 400 mm, face plate Ø 500 mm (Sinus 400), face plate Ø 450 mm (Sinus 330), dog plate, quick tool changer head, quick change tool holder, fixed splash guard (wall), coolant system, steady and follow rests, taper turning unit, chuck guard, work lamp, reducing sleeves, dead center, operating tools, operator manual

## Options

For available options for this machine, visit our website and search for Sinus D (Product Search)

Taper turning unit is included

Specifications Sinus D		330/1500	330/2000	330/3000	400/1500	400/2000	400/3000
<b>Working area</b>							
Workpiece length (max.)	mm	1.500	2.000	3.000	1.500	2.000	3.000
Turning diameter over bed	mm	660	660	660	800	800	800
Turning-Ø over support	mm	440	440	440	570	570	570
Turning diameter without gap bridge	mm	900	900	900	1.035	1.035	1.035
Gap bridge length	mm	320	320	320	330	330	330
Bed width	mm	400	400	400	400	400	400
<b>Travels</b>							
Travel X-axis	mm	368	368	368	420	420	420
Travel Z1-axis	mm	230	230	230	230	230	230
Swing range of top slide		45°	45°	45°	70°	70°	70°
<b>Headstock</b>							
Spindle speed	1/min	(16) 25 - 1.600	(16) 25 - 1.600	(16) 25 - 1.600	(16) 25 - 1.600	(16) 25 - 1.600	(16) 25 - 1.600
Spindle bore	mm	105	105	105	105	105	105
Spindle mount		D1-8	D1-8	D1-8	D1-8	D1-8	D1-8
Spindle taper	MT	5	5	5	5	5	5
<b>Feed</b>							
Feed X-axis (25)	mm/R	0,022 - 0,74	0,022 - 0,74	0,022 - 0,74	0,022 - 0,74	0,022 - 0,74	0,022 - 0,74
Feed Z-axis (25)	mm/R	0,044 - 1,48	0,044 - 1,48	0,044 - 1,48	0,044 - 1,48	0,044 - 1,48	0,044 - 1,48
<b>Tapping</b>							
Tapping, metric	mm	(54) 0,45 - 120	(54) 0,45 - 120	(54) 0,45 - 120	(54) 0,45 - 120	(54) 0,45 - 120	(54) 0,45 - 120
Tapping, diametric	DP	(42) 0,88 - 160	(42) 0,88 - 160	(42) 0,88 - 160	(42) 0,88 - 160	(42) 0,88 - 160	(42) 0,88 - 160
Tapping, module	mm	(46) 0,25 - 60	(46) 0,25 - 60	(46) 0,25 - 60	(46) 0,25 - 60	(46) 0,25 - 60	(46) 0,25 - 60
Tapping, whitworth	TPI	(54) 7/16 - 80	(54) 7/16 - 80	(54) 7/16 - 80	(54) 7/16 - 80	(54) 7/16 - 80	(54) 7/16 - 80
<b>Rapid feed</b>							
Rapid feed X-axis	mm/min	2.000	2.000	2.000	2.000	2.000	2.000
Rapid feed Z-axis	mm/min	4.000	4.000	4.000	4.000	4.000	4.000
<b>Tailstock</b>							
Tailstock taper	MT	5	5	5	5	5	5
Tailstock quill diameter	mm	90	90	90	90	90	90
Tailstock quill stroke	mm	235	235	235	235	235	235
Tailstock traverse adjustment	mm	± 12,5	± 12,5	± 0,5 in	± 11	± 11	± 11
<b>Drive capacity</b>							
Motor rating main drive	kW	7,5	7,5	7,5	7,5	7,5	7,5
Supply voltage	V	400	400	400	400	400	400
<b>Measures and weights</b>							
Overall dimensions (length x width x height)	m	3,21x1,23x1,6	3,71x1,23x1,6	4,71x1,23x1,6	3,24x1,14x1,14	3,74x1,14x1,91	4,74x1,14x1,91
Weight	kg	2.800	2.900	3.300	3.220	3.500	3.870
Part No.		300010	300011	300012	300015	300013	300014



Turnado 230/1000 with 3-axis position indicator is shown



See this machine  
in action on  
YouTube



**For more machines of this series with infinitely variable speed adjustment, visit our website**

- Cost-effective, lasting value
- Practically arranged control panel with ergonomic layout of selection levers
- Camlock spindle mount D1-6 and D1-8
- Wide bed, ground and hardened
- Offset tailstock for taper turning
- Large number of thread leads
- Removable gap bridge for machining of large diameter
- Stop spindle with adjustable travel stops



Turnado V: Constant cutting speed for flawless surfaces

**Online: Turnado V models with infinitely variable speed control up to 3000 rpm ([www.knuth.com](http://www.knuth.com))**

- Back gearing, first-class control technology and a powerful headstock motor allow a wide range of speeds and high torque for powerful machining
- The extensive features of the X.Pos position indicator (catalog page 301) are complemented here with a digital speed indicator and an easy to program auxiliary function Constant speed - During face turning, the spindle speed automatically adapts to the changing workpiece diameter – the constant cutting speed at the cutting edge of the turning tool ensures superior turning results with a quality comparable to CNC lathes



Large steady and follow rests are included

## Standard Equipment

3-axis position indicator, 3-jaw chuck Ø 250 mm (Turnado 230), 3-jaw chuck Ø 315 mm (Turnado 280), 4-jaw face plate chuck Ø 300 mm (Turnado 230), face plate Ø 450 mm (Turnado 280), quick tool changer head, quick change tool holder, coolant system, follow and steady rests, stop spindle, fixed splash guard (wall), chuck guard, foot brake pedal, LED work lamp, reducing sleeve, dead center, thread gauge, operating tools, operator instructions

Options	Part No.
• Quick-Set Spindle Bore Stop Size 9 79-91mm	103025
• Oscillation element LK 6	103332
• 4-Jaw Lathe Chuck Steel 315 mm	146483

For additional options for this machine, visit our website and search for Turnado.

Specifications Turnado		230/1000	230/1500	230/2000	280/1500	280/2000
<b>Working area</b>						
Workpiece length (max.)	mm	1.000	1.500	2.000	1.428	1.928
Turning diameter over bed	mm	460	460	460	560	560
Turning-Ø over support	mm	224	224	224	355	355
Turning diameter over gap bridge	mm	690	690	690	785	785
Gap bridge length	mm	155	155	155	170	170
Bed width	mm	300	300	300	350	350
<b>Travels</b>						
Travel X-axis	mm	285	285	285	316	316
Travel Z1-axis	mm	128	128	128	130	130
Swing range of top slide		± 52°	± 52°	± 52°	± 52°	± 52°
<b>Headstock</b>						
Spindle speed	1/min	(12) 25 - 2.000	(12) 25 - 2.000	(12) 25 - 2.000	(12) 25 - 1.600	(12) 25 - 1.600
Spindle bore	mm	58	58	58	80	80
Spindle mount		Camlock D1-6	Camlock D1-6	Camlock D1-6	Camlock D1-8	Camlock D1-8
Spindle taper	MT	6	6	6	7	7
<b>Feed</b>						
Feed X-axis	mm/R	0,014 - 0,784	0,014 - 0,784	0,014 - 0,784	0,02 - 0,573	0,02 - 0,573
Feed Z-axis	mm/R	0,031 - 1,7	0,031 - 1,7	0,031 - 1,7	0,059 - 1,646	0,059 - 1,646
<b>Tapping</b>						
Tapping, metric	mm	(47) 0,1 - 14	(47) 0,1 - 14	(47) 0,1-14	(47) 0,2 - 14	(47) 0,2 - 14
Tapping, diametric	DP	(50) 4-112	(50) 4-112	(50) 4-112	(50) 4-112	(50) 4-112
Tapping, module	mm	(39) 0,1 - 7	(39) 0,1 - 7	(39) 0,1 - 7	(39) 0,1 - 7	(39) 0,1 - 7
Tapping, whitworth	TPI	(60) 2-112	(60) 2-112	(60) 2-112	(60) 2-112	(60) 2-112
<b>Tailstock</b>						
Tailstock quill diameter	mm	60	60	60	75	75
Tailstock taper	MT	4	4	4	5	5
Tailstock quill stroke	mm	120	120	120	180	180
Tailstock traverse adjustment	mm	± 13	± 13	± 13	± 12	± 12
<b>Drive capacity</b>						
Motor rating main drive	kW	5,5	5,5	5,5	5,5	5,5
<b>Measures and weights</b>						
Overall dimensions (length x width x height)	m	2,2x1,08x1,34	2,75x1,08x1,34	3,25x1,08x1,34	2,84x1,15x1,34	3,34x1,15x1,46
Weight	kg	1.720	1.970	2.100	2.370	2.720
Part No.		320555	320558	320557	320559	320560



- **Infinitely variable speed range**
- **Apron with rapid feed motor**
- **Extensive standard equipment**
- **Constant cutting speed**

- With a new apron design, rapid feed and a modern ergonomic machine frame, the Turnado Lathe PRO series continues its success story
- A heavily ribbed machine bed, rigid headstock and a massive one-piece cast-iron stand form a solid machine base
- Removable bridge allows machining of short workpieces with large diameters
- Back-gearing and an advanced electronic control technology of the powerful main spindle drive ensure high torque and a wide range of speeds
- High-precision pre-loaded spindle bearings ensure superior concentricity and load capacity
- All guides are adjustable
- Gears, transmission shafts, and guideways are hardened and ground to guarantee quiet operation and long tool life
- The apron runs in an oil bath for low maintenance and high reliability
- A central lubrication system inside the support supplies all guideways with lubrication and simplifies maintenance
- Micrometer bed stop ensures high repeatability on the Z-axis
- The tailstock can be adjusted sideways for taper turning
- The extensive features of the X.Pos Position Indicator are complemented here with a digital speed indicator and an easy to program auxiliary function
- Constant cutting speed: During face turning, the spindle speed automatically adapts to the changing workpiece diameter – the constant cutting speed at the cutting edge of the turning tool ensures superior turning results with quality comparable to CNC lathes



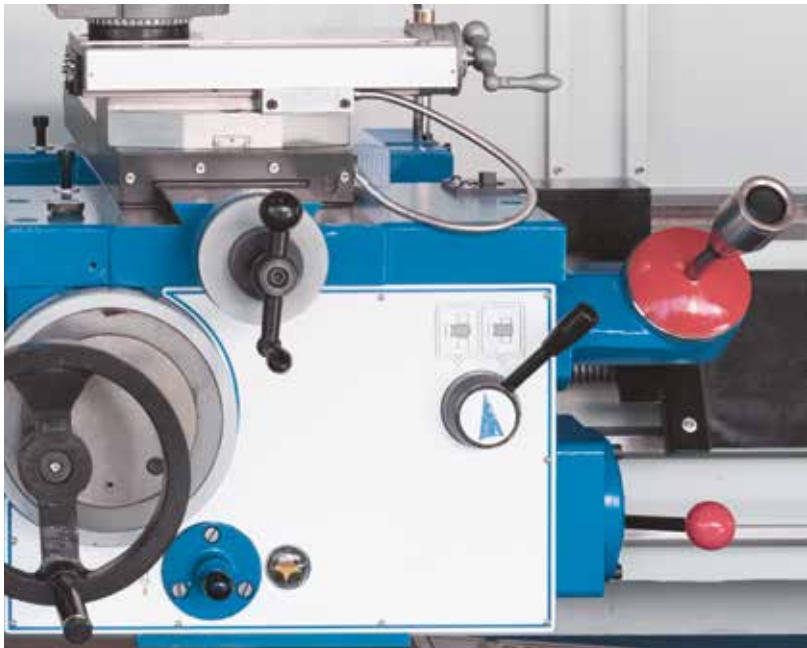

## Standard Equipment

3-axis position indicator, 3-jaw chuck, 4-jaw face chuck, face plate, quick tool changer head, quick change tool holder, coolant system, steady and follow rests, rapid feed, fixed splash guard (wall), chuck guard, foot brake pedal, LED work lamp, reducing sleeve, dead center, Micrometer bed stop, operating tools, operator instructions

## Options

## Part No.

• 4-Jaw Lathe Chuck Steel 315 mm	146483
• Quick-Set Spindle Bore Stop Size 9 79-91mm	103025
• Oscillation element LK 6	103332

For additional options for this machine, visit our website.

Support moves in linear and cross direction via motorized rapid feed for reduced down-time

## Specifications Turnado PRO

		230/1000	230/1500	280/1500
<b>Working area</b>				
Center width	mm	1.000	1.500	1.500
Center height	mm	230	230	280
In-gap diameter over bed	mm	460	460	560
Turning diameter over gap bridge	mm	690	690	785
Turning-Ø over support	mm	224	224	355
Gap bridge length	mm	155	155	170
Bed width	mm	300	300	350
<b>Travels</b>				
Travel X-axis	mm	285	285	316
Travel Z1-axis	mm	128	128	130
Swing range of top slide		± 52°	± 52°	± 52°
<b>Headstock</b>				
Speed range, low	1/min	30 - 600	30 - 600	25 - 200
Speed range, high	1/min	600 - 3.000	600 - 3.000	200 - 1.600
Spindle bore	mm	58	58	80
Spindle mount		Camlock D1-6	Camlock D1-6	Camlock D1-8
<b>Feed</b>				
Feed X-axis	mm/R	0,025 - 1,384	0,025 - 1,384	0,02 - 0,573
Feed Z-axis	mm/R	0,055 - 3,061	0,055 - 3,061	0,059 - 1,646
<b>Tapping</b>				
Tapping, metric	mm	(41) 0,1 - 14	(41) 0,1 - 14	(41) 0,2 - 14
Tapping, diametric	DP	(50) 4-112	(50) 4-112	(50) 4-112
Tapping, module	mm	(34) 0,1 - 7	(34) 0,1 - 7	(34) 0,1 - 7
Tapping, whithworth	TPI	(60) 2-112	(60) 2-112	(60) 2-112
<b>Tailstock</b>				
Tailstock quill diameter	mm	60	60	75
Tailstock taper		MK 4	MK 4	MK 5
Tailstock quill stroke	mm	120	120	180
Tailstock traverse adjustment	mm	± 13	± 13	± 12
<b>Drive capacity</b>				
Motor rating main drive	kW	7,5	7,5	7,5
<b>Measures and weights</b>				
Overall dimensions (length x width x height)	m	2,75x1,08x1,34	2,75x1,08x1,34	2,84x1,15x1,46
Weight	kg	1.720	1.970	2.370
Part No.		320562	320563	320564



See this machine  
in action on  
YouTube 



Shown with optional equipment

- Extensive standard Equipment
- Speeds up to 3000 rpm
- Constant cutting speed

- **Constant cutting speed:** During face turning, the spindle speed automatically adapts to the changing workpiece diameter – the constant cutting speed at the cutting edge of the turning tool ensures superior turning results with quality comparable to CNC lathes
- A heavy ribbed machine bed and a massive one-piece cast-iron frame provide the solid basis for this machine
- Wide, hardened and ground guideways ensure superior turning results and long life
- headstock gears and shafts are hardened and ground for quiet operation und constant speed



Steady and follow rests are included

- 5.5 kW headstock motor ensures powerful machining
- spindle speeds are infinitely variable from 30 to 550 and 550 to 3000 rpm
- micrometer and turret stop are included
- integrated central lubrication at the support for low maintenance
- incl. 3-axis position indicator with integrated spindle speed display, fully assembled



## Standard Equipment

3-axis position indicator, 4-jaw face plate chuck Ø 250 mm, face plate, change gears, quick change tool holder head WB, quick change tool holder, coolant system, steady and follow rests, turret stop, micrometer stop, chip tray, fixed splash guard (wall), protective shield for support, chuck guard, foot brake pedal, LED work lamp, thread gauge, operating tools, operator instructions

## Options

## Part No.

• 3-Jaw Lathe Chuck Steel 200 mm	146372
• Tool Holder WBD 32x140	103294
• Turning Tool Set 8 pcs., 20 mm	108700

For additional options for this machine, visit our website.

Quick-change tool holder

## Specifications

## V-Turn 410/1000

## V-Turn 410/1500

Working area		V-Turn 410/1000	V-Turn 410/1500
Center width	mm	1.000	1.500
Center height	mm	205	205
Turning diameter over bed	mm	380	380
Turning diameter over gap bridge	mm	580	580
Turning-Ø over support	mm	255	255
Gap bridge length	mm	250	190
Bed width	mm	250	250
Travels			
Travel X-axis	mm	210	210
Travel Z1-axis	mm	140	140
Swing range of top slide		± 45°	± 45°
Headstock			
Speed range, high	1/min	550 - 3.000	550 - 3.000
Speed range, low	1/min	30 - 550	30 - 550
Spindle bore	mm	52	52
Spindle mount		Camlock D1-6	Camlock D1-6
Spindle taper	MT	6	6
Feed			
Feed X-axis	mm/R	0,025 - 0,85	0,025 - 0,85
Feed Z-axis	mm/R	0,05 - 1,7	0,05 - 1,7
Tapping			
Tapping, metric		(39) 0,2-14 mm	(39) 0,2-14 mm
Tapping, diametric	DP	(21) 8-44	(21) 8-44
Tapping, module	mm	(18) 0,3 - 3,5	(18) 0,3 - 3,5
Tapping, whithworth	TPI	(45) 2-72	(45) 2-72
Tailstock			
Tailstock quill diameter	mm	50	50
Tailstock taper	MT	4	4
Tailstock quill stroke	mm	120	120
Tailstock traverse adjustment	mm	± 13	± 13
Drive capacity			
Motor rating main drive	kW	5,5	5,5
Measures and weights			
Overall dimensions (length x width x height)	m	1,94x1x1,32	2,44x1x1,32
Weight	kg	1.200	1.800
Part No.		300820	300821



See this machine  
in action on  
YouTube



## Extensive standard equipment

- incl. 3-axis position indicator with integrated spindle speed display, fully assembled
- The redesigned machine enclosure and added safety features make this machine even more ergonomic, complementing functionality and design
- constant speed: During face turning, the spindle speed automatically adapts to the changing workpiece diameter – the constant cutting speed at the cutting edge of the turning tool ensures superior turning results with quality comparable to CNC lathes
- A heavily ribbed machine bed, rigid headstock and a massive one-piece cast-iron stand form a solid machine base
- Wide, induction-hardened guideways ensure superior turning results and long life
- Facing and top slides feature adjustable guideways and spindle nuts
- High-precision pre-loaded spindle bearings ensure superior concentricity and load capacity
- A powerful 5.5 kW main spindle motor ensures rapid acceleration and powerful chip removal across the entire speed range

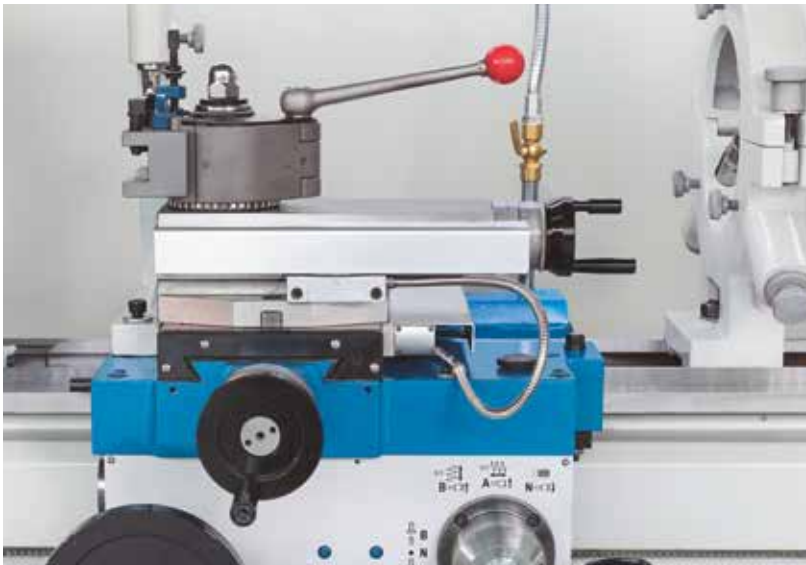

Extensive accessories, including quick-change tool holder system



Central lubrication is integrated into the support for easy maintenance and handling

## Specifications V-Turn 410 PRO

<b>Working area</b>		
Center width	mm	1.000
Center height	mm	205
Turning diameter over bed	mm	380
Turning diameter over gap bridge	mm	580
Turning-Ø over support	mm	255
Gap bridge length	mm	250
Bed width	mm	250
<b>Travels</b>		
Travel X-axis	mm	210
Travel Z1-axis	mm	140
Swing range of top slide		± 45°
<b>Headstock</b>		
Speed range, high	1/min	550 - 3.000
Speed range, low	1/min	30 - 550
Spindle bore	mm	52
Spindle mount		Camlock D1-6
Spindle taper	MT	6
<b>Feed</b>		
Feed X-axis	mm/R	0,013 - 0,45
Feed Z-axis	mm/R	0,026 - 0,9
<b>Tapping</b>		
Tapping, metric	mm	(39) 0,2-14
Tapping, diametric	DP	(21) 8-44
Tapping, module	mm	(18) 0,3 - 3,5
Tapping, whithworth	TPI	(45) 2-72
<b>Tailstock</b>		
Tailstock quill diameter	mm	50
Tailstock taper	MT	4
Tailstock quill stroke	mm	120
Tailstock traverse adjustment	mm	± 13
<b>Drive capacity</b>		
Motor rating main drive	kW	5,5
Supply voltage	V	400
<b>Measures and weights</b>		
Overall dimensions (length x width x height)	m	1,94x1x1,5
Weight	kg	1.210
Part No.		300822

- Back-gearing ensures high torque for highly efficient machining
- the extensive features of the X.Pos Position Indicator are complemented here with a digital speed indicator and an easy to program auxiliary function

## Standard Equipment

3-axis position indicator, 4-jaw face plate chuck Ø 250 mm, face plate Ø 350 mm, change gears, quick change tool holder head WB, quick change tool holder WBD 25120, coolant system, steady and follow rest, chip tray, includes fixed splash guard (wall), protective shield for support, setup elements, operating tools, operator manual

Options	Part No.
• 3-Jaw Lathe Chuck Steel 200 mm	146372
• Quick-Set Spindle Bore Stop Size 6 46-58mm	103020
• Coolant Concentrate 5 Ltr.	103184
• Live Center MT 4	106755
• Oscillation Element LK 3	103330
• Accessory-Set MT 4 8-pc.	104594
• Power Worker Metal Cutter	123040
• Live Centers, assortment MT 4	106790
• Measuring Tool Set M5	108344

**Extensive standard equipment**



See this machine  
in action on  
YouTube 

### Basic 180 V

- Speeds up to 3.000 rpm
- Constant cutting speed

- cast-iron bed, heavily ribbed
- all box ways are induction-hardened and precision-ground
- headstock with D1-4' mount, bore diam. 38 mm, run in 2 adjustable tapered roller bearings
- all gears are made of Cr-Ni steel, hardened, precision-ground, with oil-bath lubrication
- tailstock can be moved  $\pm 10$  mm for taper turning
- guides are adjustable via tapered gibs
- test certificate in accordance with DIN
- including 3-axis position indicator, fully assembled

### Basic 180 V with infinitely variable speed

- position indicator with speed display
- infinitely variable spindle speed on 2 gear levels
- speed up to 3000 min<sup>-1</sup>
- constant cutting speed: speed adapts to the part radius - constant speed ensures uniform quality finish at any diameter.
- main motor rating 4 kW

## Standard Equipment

3-axis position indicator, 4-jaw face plate chuck Ø 200 mm, face plate Ø 320 mm, change gears, quick change tool holder head WE, quick change tool holder WED 20100, coolant system, steady and follow rests, chip tray, fixed splash guard (wall), chuck guard, foot brake pedal, base, LED work lamp, micrometer longitudinal stop, reducing sleeves, dead center, thread gauge, operating tools, operator instructions

## Options

## Part No.

• 4-Jaw Lathe Chuck Steel 200 mm	116601
• Live Center MT 3	106750
• Oscillation Element LK 3	103330

For additional options for this machine, visit our website.



Basic 180 Super

## Specifications

		Basic 180 Super	Basic 180 V
<b>Working area</b>			
Center width	mm	1.000	1.000
Turning diameter over bed	mm	356	356
Turning-Ø over support	mm	220	220
Turning diameter over gap bridge	mm	506	506
Gap bridge length	mm	206	206
Bed width	mm	206	206
<b>Travels</b>			
Travel X-axis	mm	178	178
Travel Z1-axis	mm	92	92
Swing range of top slide		± 50°	± 50°
<b>Headstock</b>			
Spindle speed	1/min	(16) 45 - 1.800	30 - 3.000
Spindle bore	mm	38	38
Spindle mount		Camlock D1-4	Camlock D1-4
Spindle taper	MT	5	5
<b>Feed</b>			
Feed X-axis	mm/R	0,015 - 0,22	0,015 - 0,22
Feed Z-axis	mm/R	0,043 - 0,653	0,043 - 0,653
<b>Tapping</b>			
Tapping, metric		(37) 0,4-7 mm	(37) 0,4-7 mm
Tapping, whithworth	TPI	(28) 4-56	(28) 4-56
<b>Tailstock</b>			
Tailstock quill diameter	mm	45	45
Tailstock taper	MT	3	3
Tailstock quill stroke	mm	120	120
Tailstock traverse adjustment	mm	± 10	± 10
<b>Drive capacity</b>			
Motor rating main drive	kW	2,4	4
Main drive, continuous load	kW	1,5	-
<b>Measures and weights</b>			
Overall dimensions (length x width x height)	m	1,95x0,79x1,2	1,95x0,79x1,2
Weight	kg	880	880
Part No.		300805	300807



- **Advanced ergonomic design**
- **Large spindle capacity**
- **Extensive standard equipment**
- **Position indicator included**

- The fully equipped Basic PRO with its modern ergonomic design meets all requirements for universal applications in the areas of repairs, training and production
- The lathe bed is made of high-quality cast-iron for maximum stability and rigidity
- All gears, transmission shafts, and guideways are hardened and ground to guarantee very quiet operation and long tool life
- Wide guideways are hardened and ground to reduce wear and allow readjustments for long-term accuracy
- Readjustable spindle bearings ensure high precision and low wear for a long service life





Position indicator on X-, Z- and Z1-axis

- Gears and apron run in an enclosed oil bath for low maintenance
- Safety interlock to prevent simultaneous operation of lead screw and feed shaft feed
- Stainless steel covers on lead screw and feed shaft ensure safety without the usual restrictions, while also preventing contamination and early wear
- The tailstock can easily be positioned on the machine bed and moved sideways for taper turning
- High-performance coolant system is included
- The machine base features ample storage space for accessories and tools, including a chip tray that can be removed at front
- The X.Pos position indicator provides easy to program auxiliary functions

## Specifications

## Basic 170 Super Pro

Working area	
Center width	mm 1.000
Center height	mm 179
In-gap diameter over bed	mm 360
Turning-Ø over support	mm 223
Bed width	mm 187
Travels	
Travel X-axis	mm 185
Travel Z1-axis	mm 95
Headstock	
Spindle speed	1/min (8) 70 - 2.000
Spindle bore	mm 52
Spindle mount	Camlock D1-5
Spindle taper	MT 6
Feed	
Feed X-axis	mm/R (24) 0,0291 - 2,035
Feed Z-axis	mm/R (24) 0,0406 - 2,842
Tapping	
Tapping, metric	mm (48) 0,2 - 14
Tapping, whithworth	TPI (56) 2 - 56
Tapping, diametric	DP (32) 8 - 56
Tapping, module	MP (34) 0,2 - 3,5
Tailstock	
Tailstock quill diameter	mm 42
Tailstock taper	MT 3
Tailstock quill stroke	mm 120
Drive capacity	
Motor rating main drive	kW 1,5
Measures and weights	
Overall dimensions (length x width x height)	m 1,9x0,75x1,5
Weight	kg 650
Part No.	300814

## Standard Equipment

3-axis position indicator, 3-jaw chuck Ø 160 mm, quick change tool holder, coolant system, steady and follow rests, fixed splash guard (wall), chuck guard, foot brake pedal, LED work lamp, reducing sleeve, dead center, operating tools, operator instructions

## Options

## Part No.

• Quick-Set Spindle Bore Stop Size 6 46-58mm	103020
• Coolant Concentrate 5 Ltr.	103184
• Oscillation Element LK 3	103330
• Live Centers, assortment MT 3	106785
• Mechanical Clamping (Clamping: 3 in 1)	108796
• Analog Dial Gauge	129020

# Basic 170 Super

Solid precision bench lathe with large center width



Micrometer bed stop ensures repeatability



The thread gauge allows for resuming the thread after the apron nut for retrograde motion has been opened

- Extensive standard equipment
- Max. spindle speed 2000 rpm

- hardened and ground headstocks gears
- adjustable headstock bearing
- cast-iron bed, double v-guide, hardened and ground
- oil-bath lubricated main drive and feed gear
- double-walled apron box with oil-bath lubrication

Options	Part No.
• Quick-Set Spindle Bore Stop Size 4 30-38mm	103016
• Oscillation Element LK 3	103330
• Live Centers, assortment MT 3	106785

For additional options for this machine, visit our website and search for Basic 170 Super (Product Search)

## Specifications

	Basic 170 Super	
Center width	mm	1.000
Turning diameter over bed	mm	330
Turning-Ø over support	mm	198
Spindle speed	1/min	(8) 70 - 2.000
Spindle mount		Camlock D1-4
Motor rating main drive	kW	1,5
Weight	kg	520
Part No.		300815

## Standard Equipment

3-axis position indicator, 3-jaw chuck Ø 160 mm, 4-jaw face plate chuck Ø 200 mm, face plate Ø 280 mm, quick change tool holder head WE, quick change tool holder WED 20100, steady and follow rests, fixed splash guard (wall), chuck guard, foot brake pedal, base, work lamp, dead center, operating tools, operator instructions



See this machine in action on YouTube 



Positioning indicator on X, Z and Z1 axis



Steady and follow rests are included



**Extensive standard equipment**

- hardened and ground headstock gears
- headstock with Camlock D1-4" mount, bore diam. 38 mm, run in 2 adjustable tapered roller bearings
- adjustable headstock bearing
- tailstock can be moved  $\pm 10$  mm for taper turning
- Reversing gear reversing gearbox for changing the feed direction

Options	Part No.
• Quick-Set Spindle Bore Stop Size 4 30-38mm	103016
• Oscillation Element LK 3	103330
• 4-Jaw Lathe Chuck Steel 160 mm	116600

For additional options for this machine, visit our website and search for Basic Plus (Product Search)

### Specifications

		Basic Plus
Center width	mm	810
Turning diameter over bed	mm	300
Turning- $\varnothing$ over support	mm	178
Spindle speed	1/min	(9) 60 - 1.550
Spindle mount		Camlock D1-4
Motor rating main drive	kW	1,1
Weight	kg	520
Part No.		300809

### Standard Equipment

3-axis position indicator, 3-jaw chuck  $\varnothing$  160 mm, 4-jaw face plate chuck  $\varnothing$  200 mm, face plate  $\varnothing$  250 mm, quick change tool holder WAD 1675, quick change tool holder head WA, steady and follow rests, chip tray, fixed splash guard (wall), chuck guard, base, change gears, reducing sleeves, dead center, thread gauge, operating tools, operator instructions

# Conventional milling machines

**See for yourself live:** Many models are in stock or can be viewed and tried out at a user's location near you. Make a demonstration appointment! [info@knuth.com](mailto:info@knuth.com)



## Experience our machines in action!

With our YouTube channel KNUTH Machine Tools, you stay up to date with all the news and developments.



Servo-conventional milling machine

### Servomill®

Traverse path of X-axis **680 - 1.400 mm**  
Spindle mount **SK 40 - SK 50**

The latest feed technology  
with CNC precision

from page 108 onwards



Tool milling machine

### FPK

Traverse path of X-axis **500 - 600 mm**  
Spindle mount **SK 40**

Indispensable in tool, mold,  
model and jig making

Page 114 / 115



Universal milling machine

## VHF

Traverse path of X-axis **535 - 1.000 mm**

Spindle mount **SK 40**

Drilling and milling machining with large traverse paths  
from page 126 onwards



Universal milling machine with universal milling head

## UWF

Traverse path of X-axis **600 - 1.000 mm**

Spindle mount **SK 40 - SK 50**

Mill in vertical, horizontal and in nearly all  
spindle angles

from page 120 onwards



Bed milling machine

## KB

Traverse path of X-axis **950 - 1.500 mm**

Spindle mount **SK 50**

Large drive power and traverse paths  
from page 116 onwards

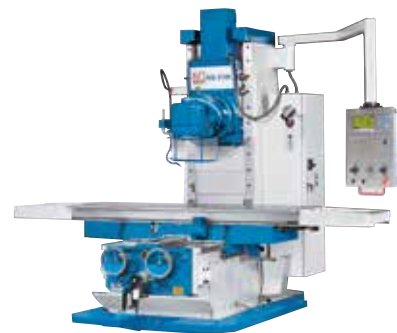

Multi-purpose milling machine

## MF

Traverse path of X-axis **670 - 800 mm**

Spindle mount **SK 30 - SK 40**

The successful multi-purpose milling machine  
- sturdier and more powerful

from page 130 onwards



Drilling-milling machine

## Mark Super / SBF

Traverse path of X-axis **420 - 560 mm**

Spindle mount **MT 4**

Compact workshop machines for drilling  
and milling work

from page 132 onwards



# KNUTH SERVO-CONVENTIONAL

## Easier to use, more precise and efficient due to integrated electronics

Are you using conventional lathes and milling machines in your workshop for flexible production of single parts and small batches? Are you considering modernizing your equipment to optimize the quality of the finished parts? Do you want to increase productivity, while reducing costs and maintenance and make work simpler and more comfortable? Our range of servo-conventional machine tools provide the right solution.

### Servomill® Highlights

- Control developed and built in Germany
- Positioning control for traveling pre-selected paths on all axes
- Constant cutting speed, whereby the feed speed is based on the spindle speed
- Zero-backlash preloaded ball screws
- Servo motors on all axes, infinitely variable feed, rapid feed, and speed control
- Electronic spindle load indicator
- Electronic hand-wheels on all axes
- X-, Y- and Z-axes can be controlled via joystick
- Integrated position indicator with glass scale

### Your Advantages

- **Simple:** Intuitive operation - practical layout of control elements and streamlined function
- **Faster:** Rapid feed on all axes reduces down-time
- **More precise:** Operated via electronic hand-wheels - axes are powered by high-quality servo drives that translate your hand movements with the precision and dynamics of modern CNC machines
- **More reliable:** Drives, spindles, and measuring systems are totally enclosed or mounted in protective enclosures and virtually maintenance-free
- **More capacity:** This machine only uses premium drive components that are designed for continuous operation
- **Maintenance-free:** No regular maintenance needed for the entire feed drive

### Advanced Feed Technology

- Electronic hand-wheels: smoother and more precise than conventional machines
- Operation via joystick: easy handling, perfect for processing of work sequences
- Electronic fixed stops: set 2 limit stops at 3 positions on each axis by the push of a button
- High repeatability and more positions than on conventional machines
- Constant cutting speed: in a selectable feed-per-spindle revolution ratio in the range of 0.01 to 1 mm/rev – ensures increased efficiency and benefit



Elektronische Endanschläge



Pocketing



Face milling

### Milling Machines

**The following servo-conventional mills are available:**

Servomill® 700	Page 109
Servomill® UFM 8V	Page 110
Servomill® UWF 5	Page 111
Servomill® UWF 10 • 12 • 15	Page 112/113

All servo-conventional KNUTH machines can be found at [www.knuth.com](http://www.knuth.com)

# Servomill® 700

The bestseller in the servo-conventional class for workshop applications and single parts production

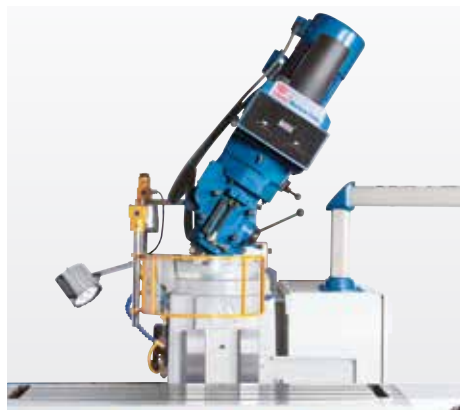

Cutter head swivels



- Advanced feed technology
- Infinitely variable servo-motors
- Electronic hand-wheels
- Electronic fixed stops

- The Servomill represents a new generation of advanced milling machines that are operated like a conventional machine
- Rigid machine base in a proven design, and meticulous workmanship
- Variability via swiveling and moving top beam
- Perfectly adjustable dovetail guide on the X-axis, and wide square guides in Y and Z direction

Options	Part No.
• Coolant Concentrate 5 Ltr.	103184
• Oscillation Element LK 5	103331
• Universal Facing / Lathe Bore Head ADA / SK40	103404

### Specifications

	Servomill® 700	
Table set up area	mm	1.370x300
Travel X-axis	mm	680
Travel Y-axis	mm	365
Travel Z-axis	mm	370
Speed range (infinitely variable, back gear ranges)	1/min	50 - 4.000
Spindle mount		ISO 40
Rapid feed X-axis	mm/min	5.000
Rapid feed Y-axis	mm/min	3.000
Rapid feed Z-axis	mm/min	2.000
Motor rating main drive	kW	3,7
Weight	kg	1.800
Part No.		301250

For additional options for this machine, visit our website and search for Servomill® 700 (Product Search)

### Standard Equipment

3-axis position indicator, electronic hand-wheels, pneumatic tool clamping, chip tray, LED work lamp, coolant system, central lubrication, horizontal guideway cover, operating tools, operator instructions



Cutter head swivels 45°

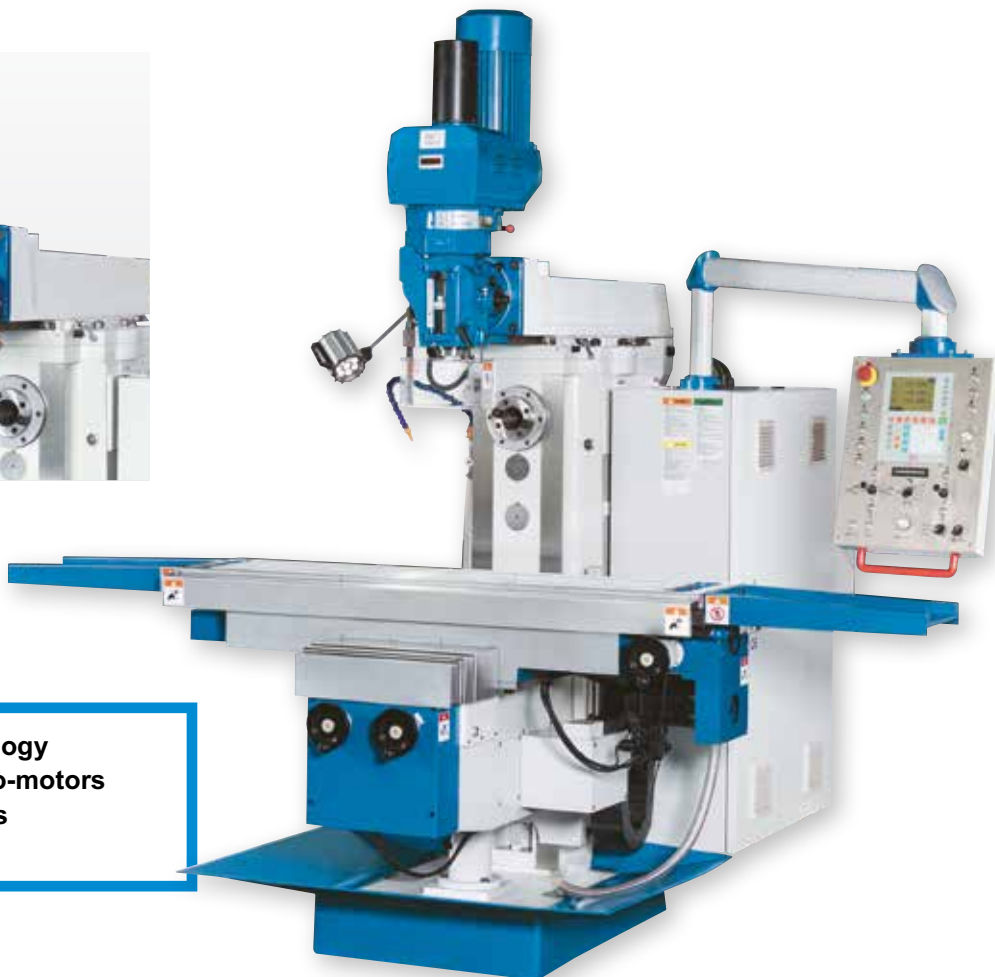

- Advanced feed technology
- Infinitely variable servo-motors
- Electronic hand-wheels
- Electronic fixed stops

- Rigid frame design with wide guideways and travels
- All gears and guideways are hardened and ground
- Swivelling vertical cutter head, pneumatic tool clamping and powerful 5.5 kW motor
- 2 gear steps for a wide speed range, infinitely variable up to 5000 rpm, and high torque at the spindle
- Horizontal spindle motor with 7.5 kW

### Options

	Part No.
• Oscillation Element LK 5	103331
• De Luxe Clamping Tool Set 16/M14	105300
• Milling Chuck Set ISO 40	106044

For additional options for this machine, visit our website and search for Servomill® UFM 8 V (Product Search)

### Specifications

	Servomill® UFM 8 V	
Table dimensions	mm	1.600x320
Travel X-axis	mm	1.300
Travel Y-axis	mm	290
Travel Z-axis	mm	450
Spindle speed (vertical)	1/min	80-650 / 650-5000
Spindle mount (vertical)		SK 40 / DIN 2080
Rapid feed X-axis	mm/min	5.000
Rapid feed Y-axis	mm/min	3.000
Rapid feed Z-axis	mm/min	1.500
Spindle speed (horizontal)	1/min	60-360 / 360-1800
Spindle mount (horizontal)		SK 50 / DIN 2080
Motor rating horizontal spindle	kW	7,5
Motor rating vertical spindle	kW	5,5
Weight	kg	2.400
Part No.		301255

### Standard Equipment

3-axis position indicator, electronic hand-wheels, pneumatic tool clamping, coolant system, work lamp, chip tray, draw bar, 4-station turret, long cutter arbor Ø 32 mm, operating tools, operator instructions



- Extremely rigid machine bed made of high-strength HT-200 cast-iron with heavy ribbing
- Precision-ground guideways with hardened surfaces for long-term accuracy and wear-resistance



- Advanced feed technology
- Infinitely variable servo-motors
- Electronic hand-wheels
- Electronic fixed stops

- Quiet precision spindle gears with hardened and ground gears
- Powerful 7.5 kW horizontal spindle and heavy-duty top beam with outer arbor ensure excellent machining results when working with long cutter arbors

### Options

### Part No.

• Oscillation Element LK 5	103331
• De Luxe Clamping Tool Set 18/M16	105305
• Divider ST 130	110960

For additional options for this machine, visit our website and search for Servomill® UWF 5 (Product Search)

### Specifications

### Servomill® UWF 5

Table dimensions	mm	1.600x320
Travel X-axis	mm	1.300
Travel Y-axis	mm	290
Travel Z-axis	mm	450
Speed range (2)	1/min	60-360 / 360-1800
Spindle mount		ISO 50
Rapid feed X-axis	mm/min	5.000
Rapid feed Y-axis	mm/min	3.000
Rapid feed Z-axis	mm/min	1.500
Motor rating main drive	kW	7,5
Weight	kg	2.800
Part No.		301254

### Standard Equipment

3-axis position indicator, electronic hand-wheels, reducing sleeve (ISO 50 / MK4), milling arbors (27, 32 mm), ISO 50 collet chucks incl. collets up to 16 mm (8 pieces), coolant system, work lamp, chip tray, draw bar, operating tools, operator instructions



Servomill® UWF 12

- **Advanced feed technology**
- **Infinitely variable servo-motors**
- **Electronic hand-wheels**
- **Electronic fixed stops**



Powerful headstock drive with auxiliary gearbox (Servomill® UWF 12)

- Rigid, torsion-proof construction with dovetail guide on X-axis, and wide square guides on Y and Z
- Large work table and long travels on all axes
- All guides are hardened, ground, and supplied with oil by a central lubrication unit
- Universal swivel head swings easily to a horizontal position

- Infinitely variable feed speeds and rapid feeds can be synchronized to spindle speed by the push of a button
- preloaded ball screw for easy and precise Feeds, and zero backlash
- Robust transmission with hardened and ground gears
- **X.pos Plus - You will gain productivity, quality and comfort**



## Standard Equipment

3-axis position indicator, collet chuck with collets (4,5,6,8,10,12,14,16 mm diam.), electronic handwheels, LED work lamp, central lubrication, coolant system, operating tools, operator manual

Options	Part No.
• ER 40 Collet Set 15 pcs.	106075
• Milling Chuck WELDON ISO 50 / Ø 6 mm	106811
• Milling Chuck WELDON ISO 50 / Ø 32 mm	106818
• HS 150 Hydraulic Machine Vise	125028
• Rotary Table RT 250	125840
• Tailstock / RT 200/250	125820
• E-Servomill UWF serials spare part package	259214

For additional options for this machine, visit our website.

Universal swivel head swings easily to a horizontal position

## Specifications

		UWF 10	UWF 12	UWF 15
<b>Working area</b>				
Table dimensions	mm	1.235x460	1.600x500	2.000x500
Table load capacity	kg	800	1.000	1.000
Number of T-slots	Pieces	5	5	5
T-slots, width	mm	18	18	18
T-slots, spacing	mm	80	80	80
<b>Travels</b>				
Travel X-axis	mm	900	1.200	1.400
Travel Y-axis	mm	650	700	700
Travel Z-axis	mm	450	500	500
<b>Milling Head</b>				
Speed range (2)	1/min	30-390 / 390-2050	30-390 / 390-2050	30-390 / 390-2050
Spindle mount		SK 40 / DIN 2080	SK 50 / DIN 2080	SK 50 / DIN 2080
Swivel angle		360°	360°	360°
Spindle center-to-table distance	mm	30 - 480	50 - 550	50 - 550
<b>Rapid feed</b>				
Rapid feed X-axis	mm/min	2.200	2.200	2.200
Rapid feed Y-axis	mm/min	2.200	2.200	2.200
Rapid feed Z-axis	mm/min	1.100	1.100	1.100
<b>Feed</b>				
Feed speed X-axis	mm/min	10 - 1.000	10 - 1.000	10 - 1.000
Feed speed Y-axis	mm/min	10 - 1.000	10 - 1.000	10 - 1.000
Feed speed Z-axis	mm/min	5 - 500	5 - 500	5 - 500
<b>Drive capacity</b>				
Motor rating main drive	kW	7,5	11	11
<b>Measures and weights</b>				
Overall dimensions (length x width x height)	m	2x2,5x2	2,2x2,5x2,1	2,6x2,5x2,1
Weight	kg	4.000	4.500	5.000
Part No.		301256	301257	301258



See this machine  
in action on  
YouTube



- Ball screws and servo motors on all axes
- Infinitely variable spindle speed
- Electronic handwheels
- Extensive standard equipment

- The Machine column made of premium cast-iron, ensures maximum dynamic rigidity and constant precision
- Precision preloaded ball screws on all axes
- Ergonomically arranged controls and a swivelling control panel plus standard digital position indicator for maximum operator comfort
- Both machines have rigid outer arbors for horizontal milling
- Despite the compact design, this machine features a large work table and large travels for versatile use

- Automatic feed on all axes, infinitely variable and with fast rapid feed
- The vertical cutter head swivels and the quill can be moved manually
- The infinitely variable main spindle drive with counter gear offers a wide speed range with high torque
- extensive accessory package included
- Central lubrication system is standard equipment
- Price incl. fully assembled 3-axis position indicator



The FPK 4.3 is constructed in the same stable way as the larger model

## Standard Equipment

electronic hand-wheels, 3-axis position indicator, central lubrication, reducing sleeves MT1, MT2, MT3, collet chuck with collets 2,3,4,5,6,8,10,12 mm, horizontal milling arbor 16mm, horizontal milling arbor 22mm, cutter arbor, long, 27 mm, horizontal milling arbor 32mm, Counterholder for horizontal milling, chip tray, coolant system, work lamp, pull rod (M16) for horizontal / vertical spindle, levelling pads and bolts, operating tools, operator manual

Options	Part No.
• Universal swivel table for FPK 6.3	253722
• Coolant Concentrate 5 Ltr.	103184
• Shell End Milling Arbor Ø32 SK 40	103910
• HS 125 Hydraulic Machine Vise	125024

For additional options for this machine, visit our website.

## Specifications

		FPK 4.3	FPK 6.3
<b>Working area</b>			
Table dimensions	mm	400x800	450x850
Vertical table	mm	225x1.020	250x1.190
Table load capacity (max.)	kg	200	300
T-slots (number/width/spacing)	mm	6x14x63	7x14x63
T-slots, vertical table (number x width x spacing)	mm	3x14x63	3x14x63
<b>Travels</b>			
Travel X-axis	mm	500	600
Travel Y-axis	mm	400	450
Travel Z-axis	mm	400	450
<b>Vertical Milling Spindle</b>			
Travel pinole	mm	60	100
Spindle center - column (min.)	mm	165	165
Spindle center - column (max.)	mm	665	665
<b>Vertical milling head</b>			
Angular adjustment of vertical head		± 90°	± 90°
<b>Rapid feed</b>			
Rapid feed X-axis	mm/min	1.200	1.200
Rapid feed Y-axis	mm/min	1.200	1.200
Rapid feed Z-axis	mm/min	1.200	1.200
<b>Feed</b>			
Work feed X-axis	mm/min	10 - 1.000	10 - 1.000
Work feed Y-axis	mm/min	10 - 1.000	10 - 1.000
Work feed Z-axis	mm/min	10 - 1.000	10 - 1.000
<b>Horizontal Milling Spindle / Vertical Milling Spindle</b>			
Speed range	1/min	(2) 40 - 2.000	(2) 40 - 2.000
Spindle mount		ISO 40	ISO 40
<b>Drive capacity</b>			
Motor rating main drive	kW	3,2	5,5
Motor rating coolant pump	kW	0,09	0,09
<b>Measures and weights</b>			
Overall dimensions (length x width x height)	m	1,5x1,7x1,8	1,6x1,8x2
Weight	kg	1.550	1.750
Part No.		302340	302341

The KB 2100 is also available with servo-drives on all axes

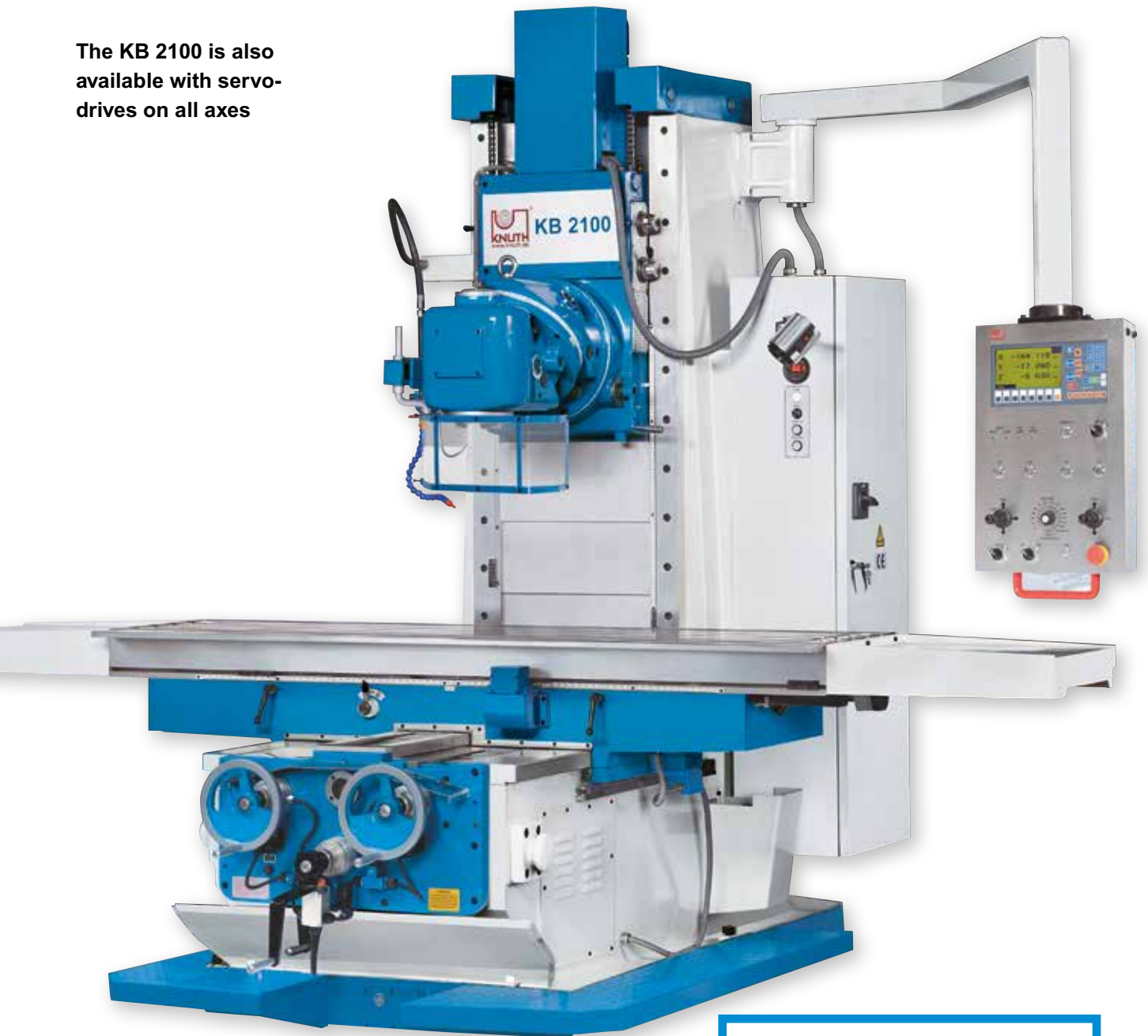

### Extensive standard equipment

- an extremely rigid, large-sized box-column design, made of premium cast-iron, provides a solid base for optimum work results
- extra wide guideways ensure maximum stability and precision at high loads
- extra long table travel distance (1500 mm) and large table set-up area (2100 x 500 mm) allow machining of large single parts or interactive machining of several parts - to give you a leading edge over your competition
- wide spindle speed ranges from 40 to 1600 rpm
- infinitely variable linear and cross feeds
- control panel on a long extending arm that can be ideally positioned by the operator



Rigid outer arbor system for long milling arbors

- This universal cutter head features maximum rigidity and quiet operation. The angle can be set manually on an infinitely adjustable scale from 90° to 45°. This allows an exact adjustment of the headstock in user-defined spatial angles and easy movement to a horizontal position.
- The KB 2100 includes a horizontal cutter arbor holder with excellent rigidity, allowing the user to fully utilize the advantages of a bed-type milling machine design for machining with long cutter arbors.



2 swivel directions allowing to set virtually any angle

## Specifications

## KB 2100

### Working area

Table set up area	mm	2.100x500
Table load capacity (max.)	kg	2.000
Number of T-slots	Pieces	4
T-slots, spacing	mm	20

### Travels

Travel X-axis	mm	1.500
Travel Y-axis	mm	670
Travel Z-axis	mm	0 - 670

### Vertical milling head

Spindle speed (vertical)	1/min	(12) 40 - 1.600
Spindle mount		ISO 50
Throat	mm	610
Vertical spindle-to-table surface distance	mm	0 - 670
Milling head swivel range	deg	360

### Rapid feed

Rapid feed X-axis	mm/min	3.500
Rapid feed Y-axis	mm/min	3.500
Rapid feed Z-axis	mm/min	1.750

### Feed

Feed speed X-axis (infinitely variable)	mm/min	20 - 1.800
Feed speed Y-axis (infinitely variable)	mm/min	20 - 1.800

### Drive capacity

Motor rating main drive	kW	7,5
Motor rating feed	kW	2
Motor rating coolant pump	kW	0,55

### Measures and weights

Overall dimensions (length x width x height)	m	3,3x2,38x2,75
Weight	kg	7.300
Part No.		301285

## Standard Equipment

3-axis position indicator, universal swivel head, coolant system, draw bar, 1 set- milling chuck set ISO 50 (4, 6, 8, 12, 16, 18, 22, 26mm), cutter arbor ISO 50 Ø 40 mm, horizontal arbor holder, horizontal arbor Ø 32 mm, work lamp, operating tools, foundation bolts M12 x 500 mm, operator manual

## Options

## Part No.

• Universal Indexing Head 200 mm / KB 2100	253647
• Optional Accessory Set / ST 155	110971
• Tailstock / RT 320	125825
• E-KB2100 spare part package for 5 years for art. no. 301285	259197

For additional options for this machine, visit our website and search for KB 2100 (Product Search)



See this machine  
in action on  
YouTube



- **Infinitely variable speed control**
- **Extensive standard equipment**

- Only the cutter head (with the part) - not the machine table - moves on the Z-axis. This results in improved stability, less vibration, and ultimately increases precision and extremely high table load capacity! This effect is emphasized even more by the large, heavy cast-iron frame (Meehanite) and extremely wide box ways.
- infinitely variable speed adjustment provided through frequency drive
- Rigid rectangular guideways for long-lasting accuracy
- Meehanite cast-iron frame
- cutter head swivels  $\pm 45^\circ$
- standard 3-axis position indicator



The very rigid cutter head can be precisely swiveled and aligned



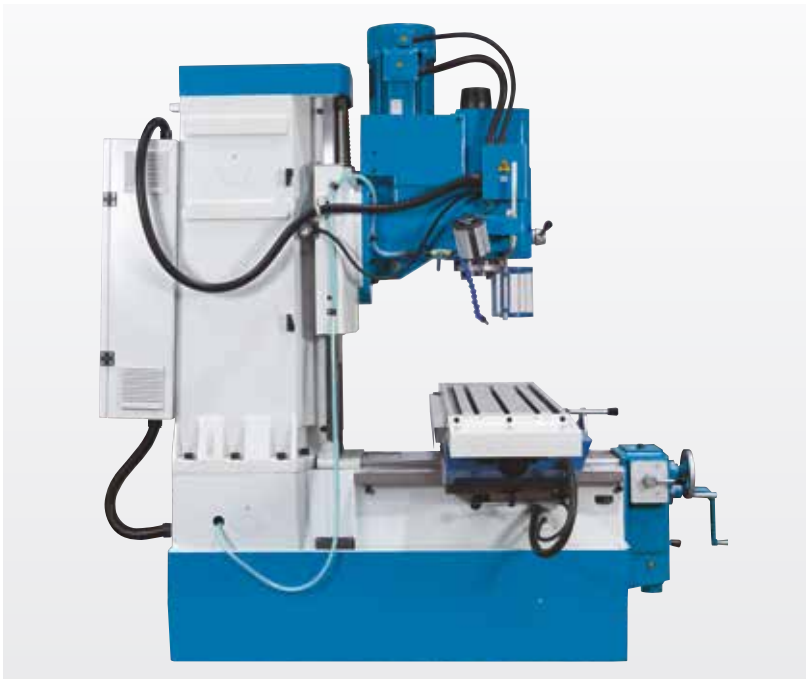

Heavy-duty design with large throat and generous work space



Face milling with cutter head

## Specifications

## KB 1400

Working area		
Spindle axis-to-table surface distance	mm	150 - 650
Number of T-slots	Pieces	3
Table set up area	mm	1.400x400
T-slots, width	mm	18
T-slots, spacing	mm	100
Speed height-adjustment (max.)	mm/min	1.670
Travels		
Travel X-axis	mm	950
Travel Y-axis	mm	400
Travel Z-axis	mm	500
Vertical milling head		
Spindle mount		ISO 50
Throat	mm	510
Spindle speed (vertical)	1/min	30 - 1.800
Quill stroke	mm	105
Head swivel range		± 45°
Rapid feed		
Rapid feed X-axis	mm/min	1.670
Rapid feed Y-axis	mm/min	1.670
Rapid feed Z-axis	mm/min	1.670
Feed		
Feed speed X-axis	mm/min	(9) 18 - 627
Feed speed Y-axis	mm/min	(9) 18 - 627
Feed speed Z-axis	mm/min	18 - 627
Drive capacity		
Motor rating main drive	kW	7,5
Motor rating feed	kW	0,75
Motor rating Z-axis	kW	0,75
Motor rating coolant pump	kW	0,04
Measures and weights		
Flow rate, coolant pump	l/min	12
Overall dimensions (length x width x height)	m	2,29x1,77x2,12
Weight	kg	3.660
Part No.		301320

## 3-axis position indicator

- more accuracy
- lower error rate
- increased productivity
- resulting in valuable time savings
- for increased productivity
- easy to read display
- operator-specific features
- resolution: 0.01/ 0.005 mm
- default coordinates
- axis position is maintained when display is turned off
- hole circle pattern calculation
- calculator function
- storage for 10 tools
- radius / diameter toggle
- mm/inch conversion

## Standard Equipment

3-axis position indicator, collet chuck with collets (4,5,6,8,10,12,14,16 mm diam.), reducing sleeves MT4, MT3, MT2, cutter arbor Ø 40 mm, coolant system, work lamp, central lubrication, operating tools, operator instructions

## Options

## Part No.

• Milling Chuck WELDON ISO 50 / Ø 25 mm	106817
• E-KB1400 spare part package for 301320	259007
• HS 150 Hydraulic Machine Vise	125028

For additional options for this machine, visit our website.

- The milling table features a large setup area, long X-axis travel, and it can be horizontally swiveled up to 45°
- The universal cutter head swivels on 2 planes, allowing virtually any spatial angle setting
- Standard outer arbor support with bronze plain bearings accommodates long milling arbors in the horizontal spindle
- Powerful axis servo-motors allow infinite adjustment of feeds on all 3 axes

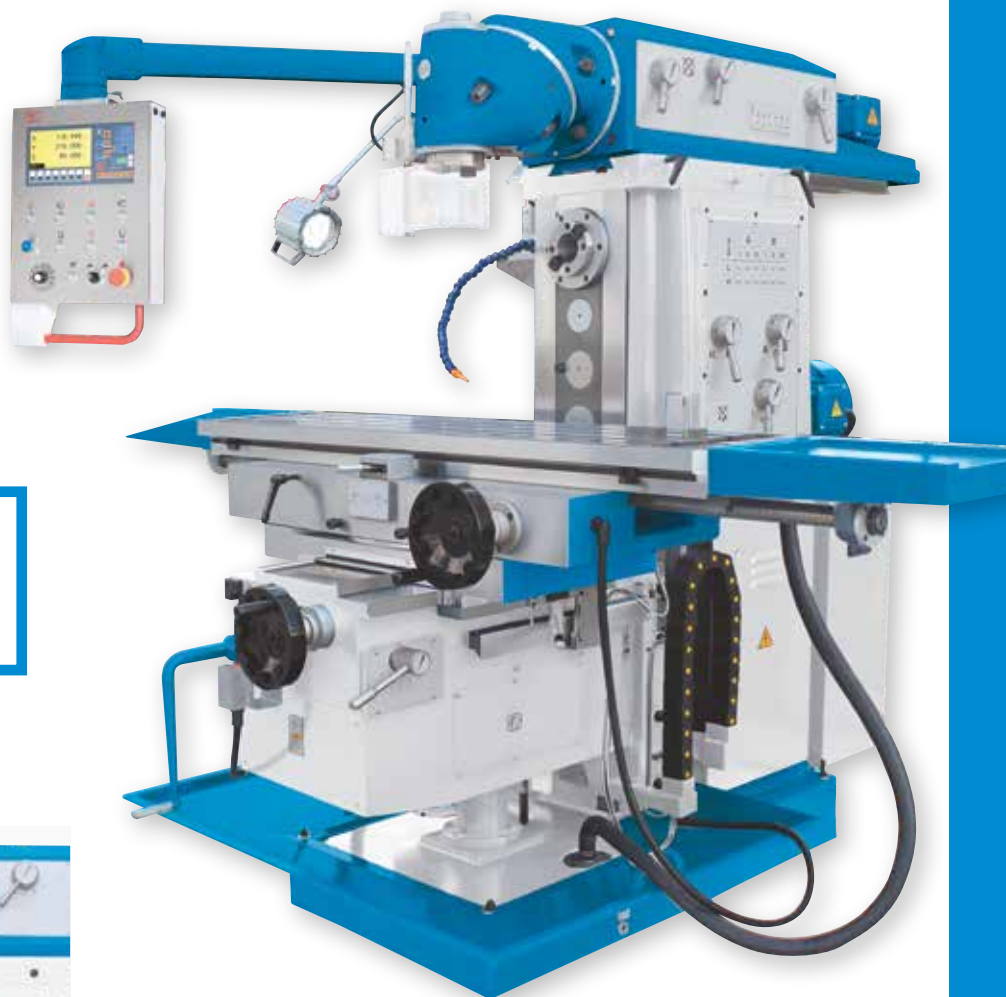

- universal cutter head
- servo motor feed
- horizontal spindle
- table swivels



Large work area, cutter head swivels on 2 planes

### Options

### Part No.

• Coolant Concentrate 5 Ltr.	103184
• Oscillation Element LK 5	103331
• Rotary Table RT 200	125835

### Specifications

### UWF 6

Table dimensions	mm	1.600x360
Speed range	1/min	(12) 60 - 1.750
Spindle mount		ISO 50
Spindle speed (horizontal)	1/min	(12) 60 - 1.800
Spindle mount		ISO 50
Motor rating horizontal spindle	kW	5,5
Motor rating vertical spindle	kW	4
Weight	kg	2.950
Part No.		362751

### Standard Equipment

3-axis position indicator, reducing sleeve ISO 50 / MT4, milling arbor Ø 32 mm, horizontal arbor Ø 27 mm, outer arbor support for horizontal milling, chip tray, coolant system, work lamp, manual central lubrication, draw bar, operating tools, operator instructions

- Extremely rigid machine bed made of high-strength HT-200 cast-iron with heavy ribbing
- Quiet, precision-made headstock gears with hardened and ground gears
- Universal cutter head swivels on 2 planes - quick change-over from horizontal to vertical machining
- Powerful axis servo-motors allow infinite adjustment of feeds on all 3 axes
- Control panel swings out to either side and features an integrated position indicator

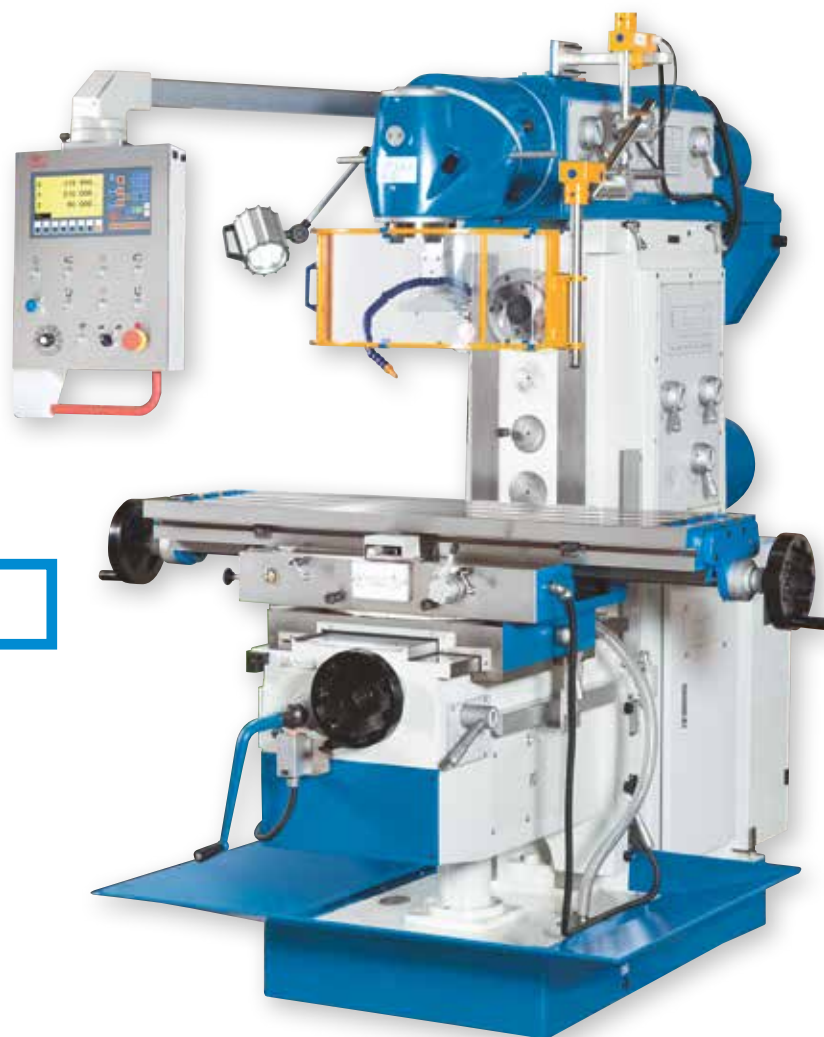

**Extensive standard equipment**



Universal cutter head, swivels on 2 planes

Options	Part No.
• Coolant Concentrate 5 Ltr.	103184
• Oscillation Element LK 5	103331
• Rotary table RT 200	125835

For additional options for this machine, visit our website and search for UWF 5 (Product Search)

### Specifications

		UWF 5
Table dimensions	mm	1.325x360
Spindle mount (horizontal)	ISO	50
Spindle speed (vertical)	1/min	(12) 60 - 1.750
Spindle mount (vertical)	ISO	50
Spindle speed (horizontal)	1/min	(12) 60 - 1.800
Motor rating horizontal spindle	kW	5,5
Motor rating vertical spindle	kW	4
Weight	kg	2.850
Part No.		362750

### Standard Equipment

3-axis position indicator, reducing sleeve ISO 50 / MT4, milling arbors (27, 32 mm), outer arbor support for horizontal milling, ISO 50 collet chucks incl. collets up to 16 mm (8 pieces), coolant system, work lamp, chip tray, draw bar, operating tools, operator instructions



See this machine  
in action on  
YouTube 

- Extremely rigid machine bed made of high-strength HT-200 cast-iron with heavy ribbing
- Large rectangular guideways ensure precision and quiet operation within permissible high loads
- Precision-ground guideways with hardened surfaces for long-term accuracy and wear-resistance
- The milling table features a large setup area and can be rotated in linear direction

- **Universal vertical cutter head design**
- **Servo-motor drive for infinitely variable feed**
- **Work table swivels in linear direction**

- Precision-ground guideways with hardened surfaces for long-term accuracy and wear-resistance
- The milling table features a large setup area and can be rotated in linear direction

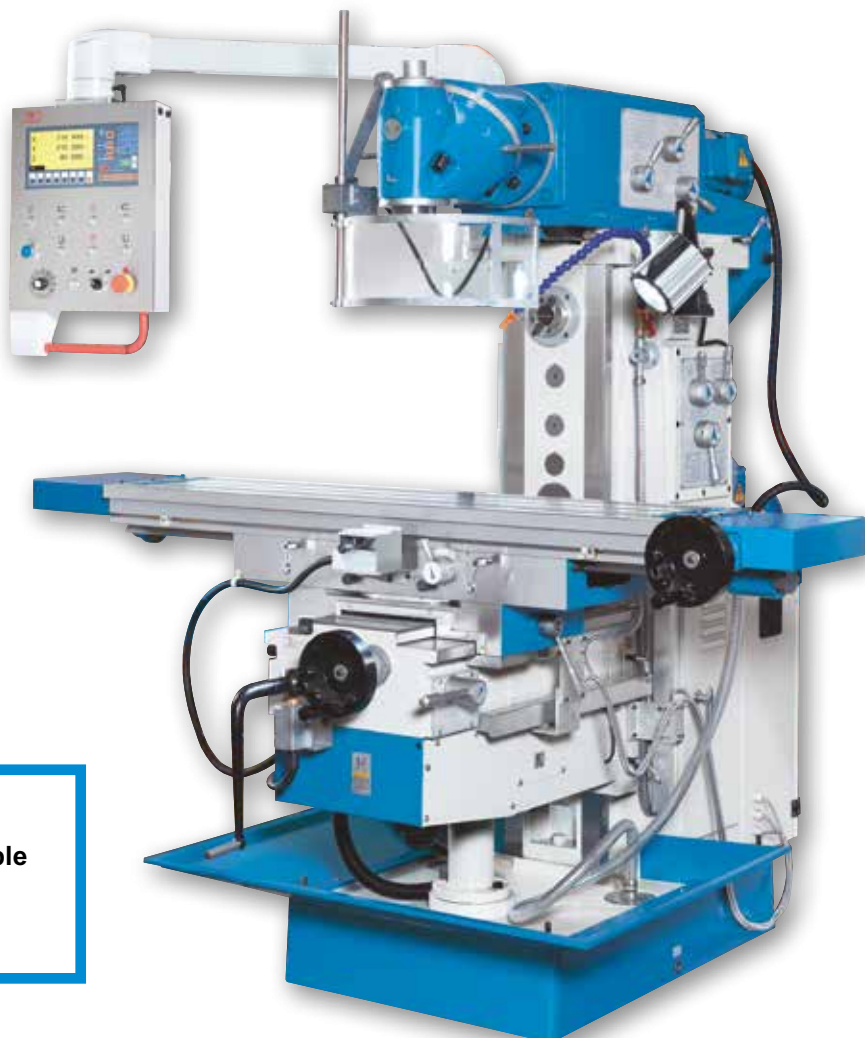

### Options

	Part No.
• Oscillation Element LK 5	103331
• Shell End Milling Arbor Ø22 SK 40	103900
• Accessory-Set ISO 40 5-pc.	104596
• Clamping Tool Set Deluxe 14/M12	105295
• ER 40 Collet Set 15 pcs.	106075
• HS 125 Hydraulic Machine Vise	125024

### Specifications

		UWF 3.2
Table set up area	mm	1.370x320
Travel X-axis	mm	1.000
Travel Y-axis	mm	360
Travel Z-axis	mm	400
Spindle speed (vertical)	1/min	(11) 45 - 1.660
Spindle mount		DIN 2080 / ISO 40
Rapid feed X-/ Y-axis	mm/min	1.335
Rapid feed Z-axis	mm/min	1.000
Spindle speed (horizontal)	1/min	(12) 35 - 1.500
Spindle mount		ISO 40
Motor rating horizontal spindle	kW	3
Motor rating vertical spindle	kW	3
Weight	kg	1.950
Part No.		362695

### Standard Equipment

3-axis position indicator, collet chuck with collets (4,5,6,8,10,12,14,16 mm diam.), horizontal arbor Ø 27 mm, outer arbor support for horizontal milling, chip tray, coolant system, central lubrication, M16 draw bar, LED work lamp, operating tools, operator instructions



See this machine  
in action on  
YouTube 



Rigid outer arbor support for long milling arbors

- Universal vertical cutter head design
- Vertical and horizontal spindle with separate drives

- sturdy, zero-backlash rectangular guideways
- Universal cutter head with 2 levels can be adjusted to virtually any angle (HURON System)
- rapid feeds on all axes allow quick positioning
- Control panel swivels for comfortable operation

### Options

### Part No.

• Oscillation Element LK 5	103331
• Adapter SK 40 / MT 4	103740
• Reduction Sleeve SK 40 / SK 30	103750

For additional options for this machine, visit our website and search for UWF 3 (Product Search)



### Specifications

### UWF 3

Table set up area	mm	1.320x320
Travel X-axis	mm	1.000
Travel Y-axis	mm	245
Travel Z-axis	mm	450
Spindle speed (horizontal)	1/min	(12) 40 - 1.300
Spindle mount		ISO 40
Spindle speed (vertical)	1/min	(11) 45 - 1.660
Spindle mount		ISO 40
Rapid feed X-axis	mm/min	1.200
Rapid feed Y-axis	mm/min	1.200
Rapid feed Z-axis	mm/min	400
Motor rating horizontal spindle	kW	3
Motor rating vertical spindle	kW	3
Weight	kg	2.000
Part No.		370297

### Standard Equipment

3-axis position indicator, central lubrication, coolant system, work lamp, collet chuck with collets (4,5,6,8,10,12,14,16 mm diam.), horizontal arbor Ø 27 mm and Ø 40 mm, outer arbor support for horizontal milling, short milling arbor 32 mm, operating tools, operator manual

- Extremely rigid machine bed made of high-strength HT-200 cast-iron with heavy ribbing
- Large rectangular guideways ensure precision and quiet operation within permissible high loads
- Universal cutter head swivels on 2 planes - quick change-over from horizontal to vertical machining
- By combining both swivel levels, almost any spatial angle can be set



- HURON-type cutter head - rigid and universal
- Servo-motor drive for infinitely variable feed
- Outer arbor support for long milling arbors
- Swiveling work table



Large throat and long travels



### Options

Options	Part No.
• Oscillation Element LK 5	103331
• Shell End Milling Arbor Ø22 SK 40	103900
• Accessory-Set ISO 40 5-pc.	104596
• Clamping Tool Set Deluxe 14/M12	105295
• ER 40 Collet Set 15 pcs.	106075
• HS 125 Hydraulic Machine Vise	125024

### Specifications

		UWF 1.2
Table set up area	mm	1.370x300
Travel X-axis	mm	1.000
Travel Y-axis	mm	360
Travel Z-axis	mm	400
Speed range	1/min	(11) 45 - 1.660
Spindle mount		DIN 2080 / ISO 40
Rapid feed X-/ Y-axis	mm/min	1.335
Rapid feed Z-axis	mm/min	1.000
Motor rating main drive	kW	3
Weight	kg	1.750
Part No.		362694

### Standard Equipment

chip tray, coolant system, central lubrication, 3-axis position indicator, operator instructions, M16 draw bar, operating tools, outer arbor support for horizontal milling

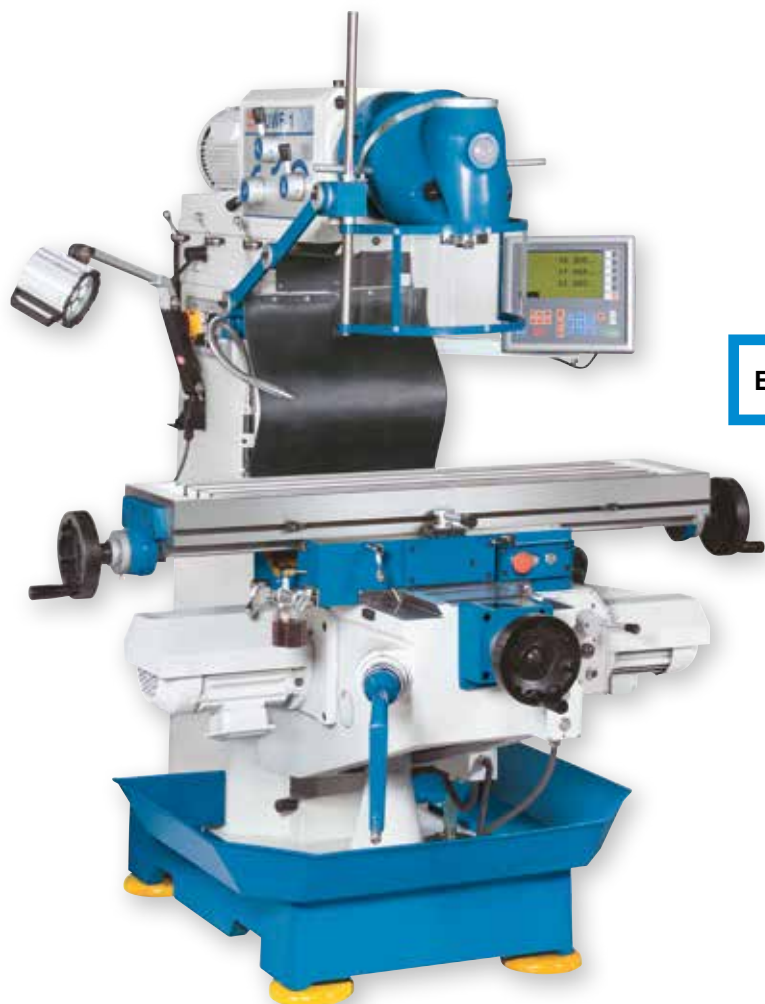

- Heavy machine frame with wide, adjustable dovetail guides in all axes
- Rigid universal cutter head, can be moved to virtually any spatial angle on two levels
- Automatic table feed on X- and Y-axes, including rapid feed
- Motorized height adjustment in Z direction

**Extensive standard equipment**



Automatic feed

### Standard Equipment

3-axis position indicator, outer arbor support for horizontal milling, milling chuck with collets 4,5,6,8,10,12,14,16 mm, long cutter arbor Ø 32 mm, coolant system, LED work lamp, operator instructions

### Options

Options	Part No.
• Oscillation Element LK 5	103331
• Clamping Tool Set Deluxe 14/M12	105295
• Rotary Table RT 200	125835

For additional options for this machine, visit our website and search for UWF 1.1 (Product Search)

### Specifications

		UWF 1.1
Table set up area	mm	1.120x260
X-axis travel	mm	600
Y axis travel	mm	240
Z-axis travel	mm	380
Spindle speed (vertical)	1/min	45 - 1.660
Spindle mount		DIN 2080 / ISO 40
Rapid feed Z-axis	mm/min	422
Motor rating main drive	kW	2,2
Overall dimensions (length x width x height)	m	1,66x1,5x1,73
Weight	kg	1.480
Part No.		362693



See this machine  
in action on  
YouTube 

- Extremely rigid machine bed made of high-strength HT-200 cast-iron with heavy ribbing
- The milling table features a large setup area and can be rotated in linear direction
- Spindle speed of vertical cutter head is infinitely variable over a wide speed range; an auxiliary gearbox ensures powerful torque
- Powerful axis servo-motors allow infinite adjustment of feeds on all 3 axes

- Vertical spindle is infinitely variable up to 3750 rpm
- Cutter head can be rotated and tilted
- Servo-motor drive for infinitely variable feed in all axes
- Horizontal spindle with outer arbor support for long milling arbors
- Milling table swivels in linear direction

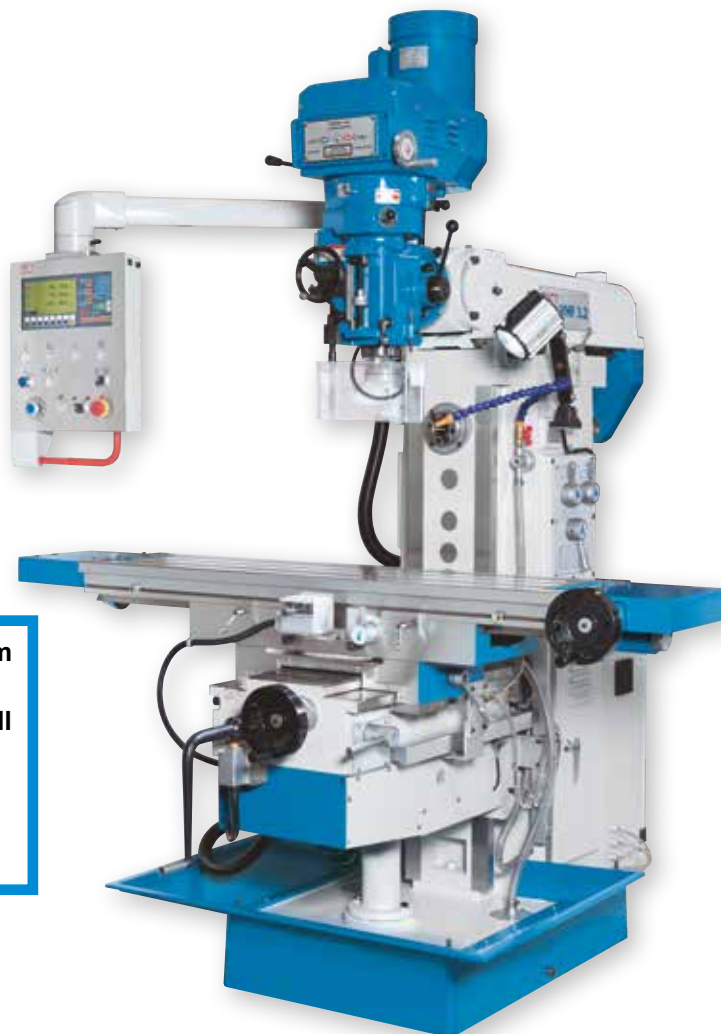

The milling table features a large setup area and can be rotated in linear direction

### Options

Options	Part No.
• Oscillation Element LK 5	103331
• Shell End Milling Arbor Ø22 SK 40	103900
• Accessory-Set ISO 40 5-pc.	104596
• Clamping Tool Set Deluxe 14/M12	105295
• ER 40 Collet Set 15 pcs.	106075
• HS 125 Hydraulic Machine Vise	125024

### Specifications

		VHF 3.2
Table set up area	mm	1.370x320
Travel X-axis	mm	1.000
Travel Y-axis	mm	360
Travel Z-axis	mm	400
Spindle speed (vertical)	1/min	50 - 3.750
Spindle mount (vertical)		ISO 40
Rapid feed X-/ Y-axis	mm/min	1.335
Rapid feed Z-axis	mm/min	1.000
Spindle speed (horizontal)	1/min	(12) 35 - 1.500
Spindle mount (horizontal)		ISO 40
Main drive motor rating (vertical)	kW	3,7
Main drive motor rating (horizontal)	kW	3
Weight	kg	1.950
Part No.		301411

### Standard Equipment

chip tray, coolant system, central lubrication, 3-axis position indicator, operator instructions, M16 draw bar, operating tools, cutter arbor Ø 27 mm





See this machine  
in action on  
YouTube 

- all 3 axes with automatic feed and rapid feeds
- spindle speeds for horizontal and vertical spindle controlled by separate switch gears with oil-bath lubrication
- capstan-controlled quill feed for drilling, manual micro-feed for milling
- for horizontal spindle operations, the top beam including head can be completely rotated on the stand

### Extensive standard equipment

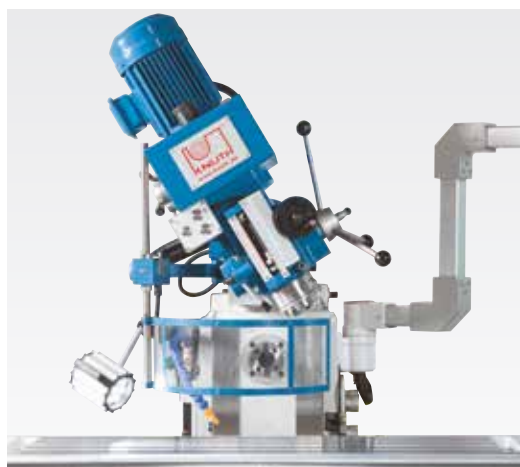

Cutter head swivels  $\pm 45^\circ$

### Options

Options	Part No.
• Coolant Concentrate 5 Ltr.	103184
• Adapter SK 40 / MT 3	103730
• Machine vise with pull-down system NZM 125	104918

For additional options for this machine, visit our website and search for VHF 3 (Product Search)



### Specifications

		VHF 3
Table set up area	mm	1.320x320
Travel X-axis	mm	1.000
Travel Y-axis	mm	245
Travel Z-axis	mm	430
Spindle mount		ISO 40
Spindle speeds	1/min	(8) 90 - 2.000
Rapid feed X-axis	mm/min	1.024
Rapid feed Y-axis	mm/min	1.024
Rapid feed Z-axis	mm/min	670
Motor rating horizontal spindle	kW	2,2
Motor rating vertical spindle	kW	2,2
Overall dimensions (length x width x height)	m	1,71x1,72x2,33
Weight	kg	1.900
Part No.		301410

### Standard Equipment

3-axis position indicator, drill chuck 16 mm, cutter arbor  $\varnothing$  27 mm, cutter arbor  $\varnothing$  40 mm, collet chuck ISO 40 with collets  $\varnothing$  4,5,6,8,10,12,14,16 mm, reducing sleeve ISO 40 / MT3 and ISO 40 / MT2, coolant system, chip tray, work lamp, operating tools, operator instructions

- The milling table features a large setup area
- vertical and horizontal spindles each have a separate drive with gearbox for maximum machining power
- the vertical head swivels to both sides ( $\pm 45^\circ$ ), quill feed through capstan or with fine feed hand wheel
- feed system with manual gearbox on X-axis and infinitely variable feed unit on the Y-axis
- height adjustment of the work table via automatic feed - precision feed via smooth hand crank

- swiveling cutter head
- automatic feed on X- and Y-axes
- horizontal spindle with outer arbor support for long milling arbors
- extensive accessory package



Swiveling control panel with integrated position indicator for maximum operator comfort

### Options

### Part No.

• Oscillation Element LK 3	103330
• Universal Facing / Lathe Bore Head ADA / SK40	103404
• Adapter SK 40 / MT 2	103720

For additional options for this machine, visit our website.

### Specifications

### VHF 2.2

Table set up area	mm	1.270x280
Table load capacity (max.)	kg	150
Travel X-axis	mm	700
Travel Y-axis	mm	340
Travel Z-axis	mm	360
Spindle speed (vertical)	1/min	(8) 115 - 1.750
Spindle mount		ISO 40
Spindle speed (horizontal)	1/min	(12) 40 - 1.300
Motor rating horizontal spindle	kW	2,2
Motor rating vertical spindle	kW	0,85 - 1,5
Weight	kg	1.400
Part No.		362651

### Standard Equipment

3-axis position indicator, coolant system, work lamp, operating tools, operator instructions, M16 draw bar, outer arbor support for horizontal milling, chip tray, cutter arbor  $\varnothing 27$  mm

- Compact, easy to handle universal milling machine with rigid frame made of vibration-dampening cast iron
- Easy to shift back-gearing via 2-step gears integrated into the vertical cutter head, plus variable frequency for high torque at the main spindle
- Entire cutter head swivels  $\pm 45^\circ$ , quill movement via capstan handle, or quill micro-feed via hand-wheel
- Horizontal spindle features a quiet, low-maintenance v-belt drive

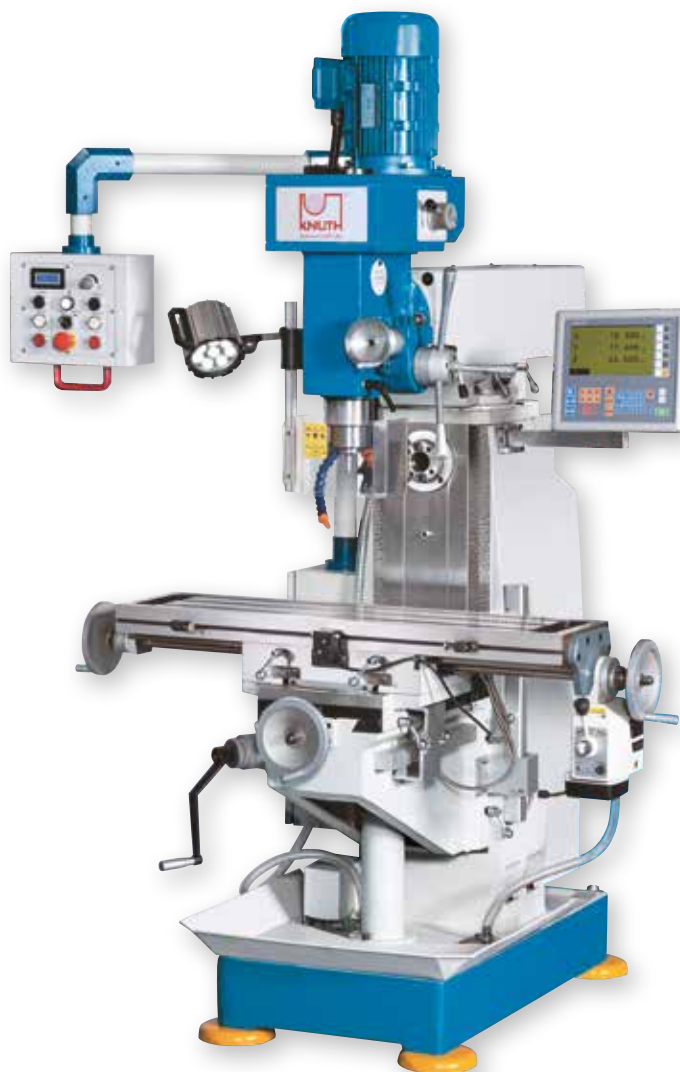

- extensive standard equipment
- vertical and horizontal spindle
- automatic feed on X axis
- infinitely variable vertical spindle speed



Solid top beam with outer arbor allows rigid mounting of long milling arbors

### Options

Options	Part No.
• Oscillation Element LK 3	103330
• Accessory-Set ISO 40 5-pc.	104596
• Machine Vise MS 125	104955

For additional options for this machine, visit our website and search for VHF 1.1 (Product Search)

### Specifications

		VHF 1.1
Table set up area	mm	1.000x240
Travel X-axis	mm	535
Travel Y-axis	mm	160
Travel Z-axis	mm	320
Spindle speed (vertical)	1/min	100 - 2.000
Spindle mount		ISO 40
Spindle speed (horizontal)	1/min	(9) 60 - 1.350
Motor rating horizontal spindle	kW	2,2
Motor rating vertical spindle	kW	1,5
Weight	kg	1.000
Part No.		362665

### Standard Equipment

3-axis position indicator, 2 long cutter arbors ( $\varnothing 22, \varnothing 27$  mm), drill chuck 16 mm, reducing sleeve ISO 40 / MT3 and ISO 40 / MT2, coolant system, work lamp, operating tools

- 3 automatic drill feeds
- manual coarse feed for quill, with change-over for manual fine feed
- quill with micrometer depth stop
- reversing switch for forward reverse rotation

- **Extensive standard equipment**
- **Infinitely variable spindle speeds up to 3600 rpm**



Variable throat widths and machining angles

Options	Part No.
• Accessory-Set ISO 40 5-pc.	104596
• Divider ST 130	110960
• HS 125 Hydraulic Machine Vise	125024

### Specifications

		MF 5 VP
Table set up area	mm	1.370x250
Travel X-axis	mm	800
Travel Y-axis	mm	390
Travel Z-axis	mm	380
Speed range	1/min	70 - 3.600
Spindle mount		ISO 40
Motor rating main drive	kW	3,75
Weight	kg	1.590
Part No.		301217

For additional options for this machine, visit our website and search for MF 5 (Product Search)

### Standard Equipment

3-axis position indicator, table feed TV 1000 on X- and Y-axis, pneumatic tool clamping, chip tray, coolant system, central lubrication, horizontal guideway cover, operating tools, operator manual

### MF 1 VP models

- The most widely used milling machine type in the world - with standard pneumatic tool clamping
- infinitely variable spindle speed via hand wheel adjustment
- Larger table with larger travel on X
- TV 1000 automatic table advance on X-axis is included, retrofitting of Y-axis available



### MF 1 P

- Speed is changed by shifting the 2-step drive motor transmission, or by selecting the desired gear ratio at the drive belt (4 speeds per gear)
- Automatic table feed, type TV 1000 on X and Y, can easily be retrofitted

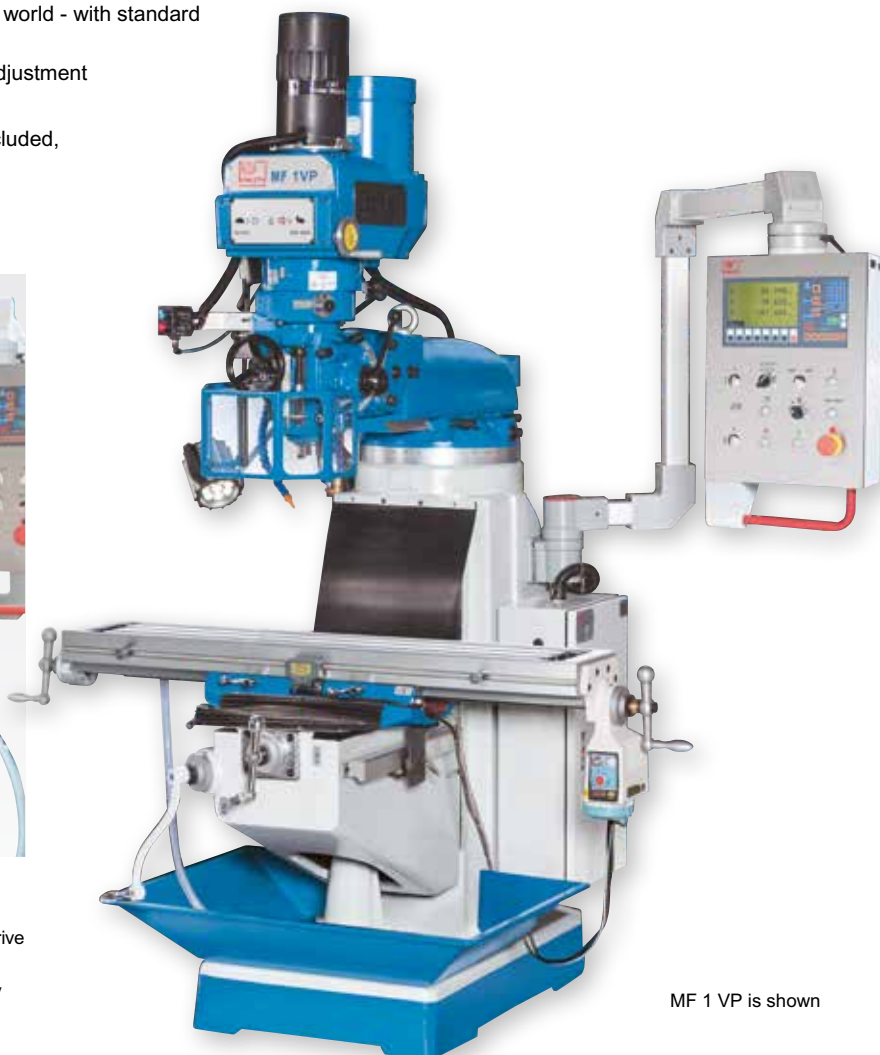

MF 1 VP is shown

### Specifications

		MF 1 P	MF 1 VP
Table set up area	mm	1.060x230	1.245x230
Travel X-axis	mm	670	760
Travel Y-axis	mm	290	290
Travel Z-axis	mm	370	370
Spindle speeds	1/min	(16) 80 - 4.500	(2) 60 - 4.200
Spindle mount		ISO 30	ISO 30
Motor rating main drive	kW	2,2	2,25
Weight	kg	1.100	950
Part No.		301219	301215

### Standard Equipment

3-axis position indicator, automatic table feed in X direction (TV 1000) (MF 1 VP), pneumatic tool clamping, coolant system, central lubrication, vertical guideway cover, LED work lamp, operating tools, operator manual

- Motorized cutter head movement and hand-wheel for exact positioning of head
- Digital depth indicator for quill travel
- Tapping unit with adjustable rotation reversal for thread cutting
- Hardened gear racks and shafts for quiet operation and long life
- **More power and variable speed control for a wider range of applications**



- **Extensive standard equipment**
- **Automatic quill feed**
- **Large travel with TV 1000 table feed**
- **Multi-function position indicator**

### Standard Equipment

3-axis position indicator, automatic quill feed, base, table feed TV 1000, drill chuck 13 mm, tool-holder bits, operator manual

### Options

### Part No.

• Clamping Tool Set Deluxe 14/M12	105295
• Mounting Shaft MT 4	108641
• Electronic Edge Tracer	129055

For additional options for this machine, visit our website and search for Mark Super S (Product Search)



See this machine  
in action on  
YouTube



Head swivels  $\pm 45^\circ$

### Specifications

		Mark Super S	Mark Super SV
Table dimensions	mm	800x240	800x240
Drilling capacity in steel	mm	32	25
Travel X-axis manual / autom.	mm	560 / 480	560 / 480
Travel Y-axis	mm	190	190
Spindle mount		MT 4	MK 4
Speed	1/min	(12) 75-3200	(2) 75-438 / 438-2500
Main motor rating	kW	1,5 / 1,1	1,5
Weight	kg	380	480
Part No.		301498	301490

# SBF 40

Universal machine for milling and drilling

- Large compound sliding table with automatic infinitely variable feed on X-axis for coordinate drilling and light milling work
- manual drill feed can be switched to high-precision feed via a hand-wheel
- controllable automatic feed with 3 gear steps
- adjustable height of gear head and table



Infinitely variable milling table feed



Automatic quill feed with 3-step gears

### Options

### Part No.

• Accessory-Set MT 4 8-pc.	104594
• ER 32 Collet Set 6 pcs.	106052
• Mounting Shaft MT 4	108641

For additional options for this machine, visit our website and search for SBF (Product Search)



### Specifications

### SBF 40

Table set up area	mm	730x210
Quill stroke	mm	120
Spindle nose-to-table surface distance	mm	600
Spindle nose-to-foot distance	mm	1.180
Drilling capacity in steel / ST37	mm	40
Speed range	1/min	(12) 75 - 3.200
Spindle mount	MT	4
Main motor rating	kW	1,5 / 1,1
Overall dimensions (length x width x height)	m	0,83x0,76x1,85
Weight	kg	390
Part No.		101573

### Standard Equipment

tapping unit, table feed TV 1000, draw bar, drill chuck, tool-holder bits, coolant system, operator manual

# Drilling machines

**See for yourself live:** Many models are in stock or can be viewed and tried out at a user's location near you. Make a demonstration appointment! [info@knuth.com](mailto:info@knuth.com)



## Experience our machines in action!

With our YouTube channel KNUTH Machine Tools, you stay up to date with all the news and developments.



## Drilling-milling machine

**BO**

Facing slide travel **180 - 250 mm**  
Traverse path of X-axis **700 - 1.600 mm**

Table load up to 10 tons and motorised swivelling clamping table

Page 136 / 137

## Radial drilling machine

**R / R V T**

Drilling capacity **32 - 100 mm**  
Spindle mount **MT 4 - MT 6**

Large throat and drilling capacity with easy handling

from page 138 onwards





Quick radial drilling machine

## KSR / KSR VT

Drilling capacity **40 - 50 mm**

Spindle mount **MT 4**

Easy handling thanks to linear guides

from page 147 onwards



Column drilling machine

## SSB

Drilling capacity **32 - 60 mm**

Spindle mount **MT 4 - MT 5**

With variable speed adjustment  
and thread cutting device

from page 151 onwards



Frame-type column drilling machine

## KSB

Drilling capacity **32 - 63 mm**

Spindle mount **MT 4 - MT 5**

Superior stability due to heavy  
column design

Page 150

Table drilling machine

## TSB / KB

Drilling capacity **20 - 35 mm**

Spindle mount **MT 2 - MT 4**

High-quality table drilling machine for  
industrial applications

from page 154 onwards



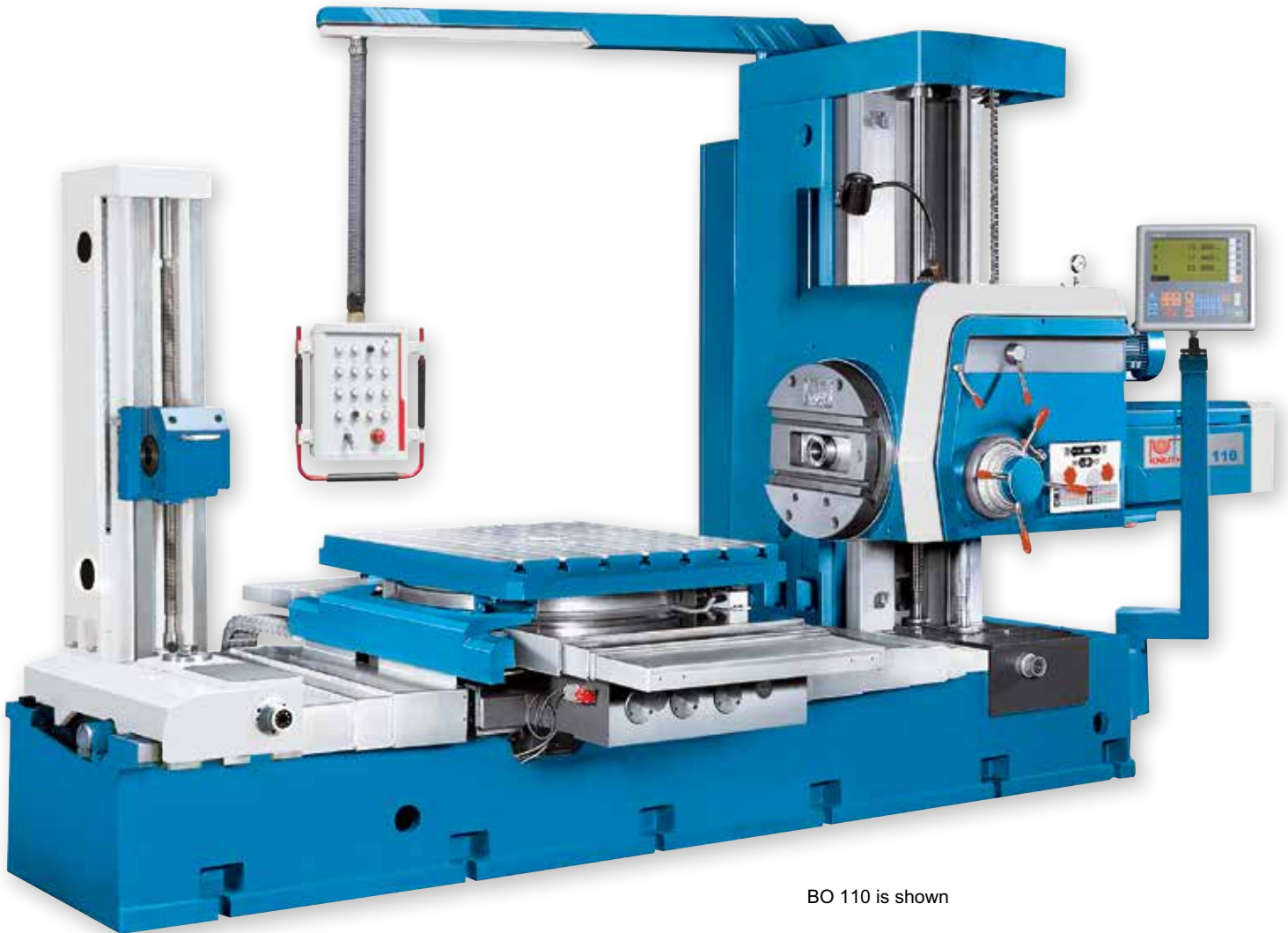

BO 110 is shown

- rigid, hardened and precision-ground square guides ensure many years of accurate operation
- mechanical functions that cannot be run simultaneously are provided with interlocks
- headstock and feed gears are equipped with an overload clutch
- lever-operated shift gears for positioning of the wheels in the desired position
- faceplate and drill spindle with different task-specific speed ranges according to the various functions

- table rotates 360°
- telescoping steel cover protects the guides from chips and dirt
- BO 110 incl. tailstock (optional on BO 130)

### Standard Equipment

3-axis position indicator, wedge strip, central lubrication, work lamp, foundation bolts, operating tools, operator manual



Options	Part No.
• Boring tool holder for facing plate for BO 130	250606
• Milling tool holder for facing plate for BO 130	250607
• Boring head	250609
• Option B axis DRO for BO 130 - 399022	252721

For additional options for this machine, visit our website and search for BO 110 or BO 130 (Product Search)

Swivelling set-up table with motorized feed and hydraulic clamping

Specifications		BO 110	BO 130
<b>Working area</b>			
Drilling capacity	mm	50	60
Table set up area	mm	1.100x960	1.600x1.800
Table load capacity	kg	2.500	10.000
Spindle axis-to-table surface distance	mm	0 - 900	0 - 1.800
Rotation speed of rotary table	1/min	1	1,2
<b>Travels</b>			
Travel X	mm	900	2.000
Travel Y	mm	900	1.800
Travel Z	mm	900	1.500
Travel W	mm	600	900
Facing slide travel	mm	180	250
<b>Headstock</b>			
Speed range	1/min	(22) 8 - 1.000	(24) 4 - 800
Spindle diameter	mm	110	130
Spindle torque (max.)	Nm	1.225	3.136
Spindle mount		SK 50	SK 50
Facing slide speed	1/min	(18) 4 - 200	(18) 2,5 - 125
Feed force, axial (max.)	kN	12,25	31,36
Facing slide torque (max.)	Nm	1.960	4.900
<b>Rapid feed</b>			
Rapid feed X-axis	mm/min	2.500	2.500
Rapid feed Y-axis	mm/min	2.500	2.500
Rapid feed W-axis	mm/min	2.500	2.500
<b>Feed</b>			
Feed X-axis	mm/R	(36) 0,01 - 6	(36) 0,01 - 6
Feed Y-axis	mm/R	(36) 0,01 - 6	(36) 0,01 - 6
Feed Z-axis	mm/R	(36) 0,01 - 6	(36) 0,01 - 6
Feed W-axis	mm/R	(36) 0,01 - 6	(36) 0,01 - 6
Facing slide feed	mm/min	(18) 0,08 - 12	(18) 0,08 - 12
<b>Accuracies</b>			
Read-out accuracy (optic)	mm	0,01	0,005
Counter-bore accuracy	µm	H7 Ra-1,6	H7 Ra-1,6
<b>Drive capacity</b>			
Motor rating main drive	kW	7,5	15
Motor rating, rapid reed	kW	3	-
Motor rating servo drive	kW	-	5,5
Motor rating hydraulic pump	kW	0,37	0,37
<b>Measures and weights</b>			
Overall dimensions (length x width x height)	m	4,88x2,45x2,75	7,03x4,66x3,8
Weight	kg	11.500	29.300
Part No.		301499	399022



R 100 is shown

- **a large throat and high boring capacities are supported by a very rigid structural design, without compromising the ease of handling and smoothness of operation**
- the drill head features a rigid design with motorized or manual movement
- spindle speeds and feed velocity are hydraulically controlled for easy and safe operation
- the drill spindle is driven via multi-disk reversing clutch to avoid excessive load peaks and for easy operation
- Base, column, boom and gear head are made of premium high-quality cast
- boom height adjustment via a powerful motorized drive and vertical spindle
- the boom lifting gears run in an oil-bath for maximum reliability and minimum wear
- advanced column swivel design with optimized clamping features maximum rigidity and minimum clamping offset
- swivel axis and travel axis feature extremely smooth operation to make the operator's everyday production work easier
- the gears feature hardened and precision-ground chrome-nickel steel for smooth and low-noise operation



Powerful machining with automatic feed



Depth stop with vernier scale

- all gear parts are lubricated reliably via oil pump
- the main spindle runs on precision bearings and features an automatic spindle brake
- quill teeth are precision-ground for a smooth feed and minimum wear
- the drill head moves on hardened and ground guideways
- Features adjustable overload clutches in the feeds
- adjustable boring depth stop with large, easy to read scale and Nonius

- all operator controls are placed within reach for convenient and practical handling and quick learning
- powerful coolant system with coolant reservoir integrated into the machine foot
- independent hydraulic clamping of head, column and boom
- drill head and column can be clamped/released together or separately; confirmation of operation via push button
- Boom and column are oiled through a reliable central lubrication system

## Specifications

**R 100**

Working area	
Drilling capacity	mm 100
Tapping capacity, cast-iron	M 80
Tapping capacity, steel	M 70
Drilling depth (max.)	mm 500
Machine table dimensions	mm 4.425x1.630x300
Cube table dimensions	mm 1.250x800x630
Throat	mm 570 - 3.150
Spindle nose-to-table surface distance	mm 750 - 2.500
Arm stroke (vertical)	mm 1.000
Column diameter	mm 700
Travels	
Drill head travel (horizontal)	mm 2.580
Headstock	
Speed range	1/min (22) 8 - 1.000
Spindle mount	MT 6
Feed	
Feeds	mm/R 0,06 - 3,2
Drive capacity	
Motor rating main drive	kW 15
Stroke motor	kW 3
Measures and weights	
Overall dimensions (length x width x height)	m 4,78x1,63x4,72
Weight	kg 20.000
Part No.	101659

## Standard Equipment

coolant system, cube table, LED work lamp, operator instructions

## Options

**Part No.**

• Coolant Concentrate 5 Ltr.	103184
• Compound Sliding Tables 855x295	106017
• HSS Form Countersing Set round 2 - 12 mm	107615
• HSS Form Countersing Set round 6 - 20 mm	107617
• Power Worker Metal Cutter	123040
• Drill Press quick-action machine vise with V-guides PBS 200	125007
• UMS 200 Universal Machine Vise	125032
• Swivel Table ST 380	129345

## Touchscreen

Electronics take conventional machines to a new level



- easy operation saves time
- improved support providing more information for the user
- intuitive access to all functions (tablet feel)
- simplified troubleshooting via diagnostic functions

Conventional machine tools are still a preferred versatile choice, especially for customization and repair of components or flexible production of single parts. Today, these machines are brought to a new level with a growing portfolio of electronic solutions for their drives and gauging systems. Conventional machines are increasingly upgraded with touchscreens for their HMIs. This type of human/machine interface opens the door to many new possibil-

ities, which we would like to demonstrate to you by presenting a few examples from the current KNUTH machine tool program.

### More precise and more efficient due to integrated electronics

KNUTH machine tools have a proven record in workshops and production facilities throughout the world, and this new technology will provide the continuation of our success story. Operators can apply their skills without adapting to a new machine or learning new programming techniques. Smart solutions bring increased efficiency and productivity, and the use of advanced components ensure maximum precision and quality. Many components are produced using large-scale series production

technology guaranteeing their ruggedness and availability. These modern machines require significantly less maintenance than mechanical solutions, which results in reduced operating costs.

**These new control panels or user interfaces are used mainly on machines that feature semi-automated functions like surface grinders and automatic band saws.**

Easy control of complex functions



On the HFS NC series surface grinders, all functions are displayed clearly organized for easy selection on the touchscreen.

**This technology also provides many advantages for machines that have to be highly versatile and still easy to operate.**



**Good examples of standard machines that are constantly becoming smarter are the series VT radial drill presses, high-speed radial drill presses, and column drill presses.**

These models not only display all functions on a large 12.1" color touchscreen, but also provide an additional feature that helps the user select the optimum drilling parameters for the task.

The "Technology Value" function allows the user to select drill diameters and materials on the display. The system-recommended values for rpm and feed speed can be accepted automatically in a quick and secure way.

The boring depth stop is set electronically, and at greater boring depths an easy to program

chip breaking function increases process safety by avoiding chip congestion and preventing winding of chips around the tool.

Spindle speed and feed rate are infinitely variable. The values are also displayed graphically, and all operational and alarm messages are shown on the screen, so the operator can monitor everything at a glance.

### **Rediscover conventional machines:**

Smart HMI technology and robust electronics make conventional machines better and more efficient.



See this machine  
in action on  
YouTube



- Unique operating concept
- Servomotor-driven quill feed
- Large touchscreen
- Rigid design and powerful performance





All functions are shown on the touchscreen's graphic display

- Base, column, boom and gear head are made of premium high-quality cast
- major design features include a large column and a highly torsion-resistant boom
- boom height adjustment via a powerful motorized drive and vertical spindle
- the boom lifting gears run in an oil-bath for maximum reliability and minimum wear
- swivel axis and travel axis feature extremely smooth operation to make the operator's everyday production work easier
- a central lubrication system ensures reliable lubrication of the column

- **Electronically controlled servo quill feed with large touchscreen display**
- Drilling depth is electronically set and the input value is checked by the system
- Measuring units for input and display can be selected by the operator (mm or inch)
- The high-performance coolant system enabled at the touchscreen and will be turned on and off as a function of the main spindle
- The machine has 2 gear steps, and the rpm can be infinitely varied and displayed at the monitor
- A servo motor provides infinitely variable control of the quill feed - upon reaching the preselected drilling depth, the quill automatically returns to the starting position
- Thread cutting is, however, completely manual, i. e., the operator changes the quill's rotational direction upon reaching the drilling depth
- The operator sets the boom height by touching the respective icon, whereupon the system automatically releases and fixates the hydraulic clamps, turns off the lift motor, and considers all set limit stops

- Drill head and column can be clamped/released together or separately
- Boom can be moved vertically without losing the spindle-to-bore alignment
- The control software also provides recommendations for rpm and feed in relation to the desired drill size
- Various alarm screens warn the operator in case of operational errors and display information on the operational state

## Specifications

### R 60 VT

Working area		
Drilling capacity	mm	60
Tapping capacity, cast-iron		M 50
Tapping capacity, steel		M 45
Drilling depth (max.)	mm	315
Throat	mm	350 - 1.600
Spindle nose-to-table surface distance	mm	350 - 1.250
Drill head travel (horizontal)	mm	1.250
Headstock		
Speed range	1/min	(2) 38 - 2.000
Spindle mount		MT 5
Feed		
Feeds	mm/min	0 - 300
Drive capacity		
Motor rating main drive	kW	4
Stroke motor	kW	1,5
Measures and weights		
Overall dimensions (length x width x height)	m	2,49x1,05x2,78
Weight	kg	3.800
Part No.		101656

## Standard Equipment

coolant system, cube table, work lamp, operator manual

## Options

### Part No.

• Extension Sleeve MT 4/5	104670
• Taper Drift MT 4/5	104695
• Tapping Attachment M8 - M20 (MT3 + MT4)	106037
• Mounting Shaft MT 4	108641
• Drill Press quick-action machine vise with V-guides PBS 200	125007



- **Infinitely variable speed control**
- **Large work area**

R 60 V

- major design features include a large column and a highly torsion-resistant boom
- advanced column swivel design with optimized clamping features maximum rigidity and minimum clamping offset
- the gears feature hardened and precision-ground chrome-nickel steel for smooth and low-noise operation
- the main spindle runs on precision bearings and features an automatic spindle brake
- quill teeth are precision-ground for a smooth feed and minimum wear
- the drill head moves on hardened and ground guideways
- all models feature adjustable overload clutches in the feeds
- adjustable boring depth stop with large, easy to read scale and Nonius
- all operator controls are placed within reach for convenient and practical handling and quick learning
- powerful coolant system with coolant reservoir integrated into the machine foot

**R 60 V • R 80 V**

- infinitely variable spindle speed and easy to read digital display
- the quills feature guided counterweights for easy handling and increased safety
- independent hydraulic clamping: boom can be moved vertically without losing the spindle-to-bore alignment
- drill head and column can be clamped/released together or separately with the push of a button



R 40 V

## R 40 V

- 40 mm boring capacity, large throat and compact dimensions
- 4-step feed gears
- infinitely variable speed control with back gearing for high torque across the entire speed range
- the boom can be moved vertically, while column and head remain clamped and fixed in their positions
- the drill head can be moved radially and positioned with high precision via a centrally located hand-wheel
- A clamping lever at the drill head allows the operator to release the boom so it can be moved via a hand-wheel, and to swivel the boom and fix it again in its position
- manual central lubrication

## Options

## Part No.

• E-R60V Spare Parts package for Art. Nr. 101649	259127
• Lathe Bore Head with Boring Bar Set 75 mm 12 pcs.	108633
• Tapping Attachment M8 - M20 (MT3 + MT4)	106037
• Universal Facing / Lathe Bore Head ADA / MT 4	103402
• E-R40 V spare part package for 5 years for art. no. 101556	259069
• Reduction Sleeve MT 4/3	103830
• E-R80 V spare part. package for 5 years for art. 101558	259070

## Standard Equipment

coolant system, cube table, LED work lamp, operator instructions

## Specifications

		R 40 V	R 60 V	R 80 V
<b>Working area</b>				
Drilling capacity	mm	40	62	80
Tapping capacity, cast-iron		M 40	M 52	M 60
Tapping capacity, steel		M 32	M 46	M 52
Drilling depth (max.)	mm	260	315	400
Machine table dimensions	mm	2.050x920x180	2.400x1.000x200	3.380x1.230x280
Cube table dimensions	mm	620x450x450	750x500x500	580x850x500
Throat	mm	300 - 1.300	350 - 1.600	450 - 2.550
Spindle nose-to-table surface distance	mm	300 - 1.200	350 - 1.250	400 - 1.580
Arm stroke (vertical)	mm	640	585	800
Column diameter	mm	280	350	450
<b>Travels</b>				
Drill head travel (horizontal)	mm	1.000	1.250	2.100
<b>Headstock</b>				
Speed range	1/min	54 - 2.150	38 - 2.000	30 - 1.400
Spindle mount		MK 4	MK 5	MK 6
<b>Feed</b>				
Feeds	mm/R	0,1 - 0,63	0,06 - 1	0,06 - 1,38
<b>Drive capacity</b>				
Motor rating main drive	kW	2,2	4	7,5
Stroke motor	kW	1,1	1,5	2,2
<b>Measures and weights</b>				
Overall dimensions (length x width x height)	m	2,07x0,85x2,43	2,49x1,05x2,78	3,59x1,25x3,53
Weight	kg	2.300	3.800	7.400
Part No.		101557	101649	101558

- machine frame made of high-quality fine-grain cast-iron with heavy ribbing to ensure maximum reduction of vibrations
- precision-ground gears for quiet operation
- practical layout of electrical and mechanical controls at the headstock for easy operation
- motorized arm height adjustment



Rigid column base with central main switch



Swiveling boom for large throat widths



See this machine  
in action on  
YouTube



## Options

## Part No.

• Universal Facing / Lathe Bore Head ADA / MT 4	103402
• Reduction Sleeve MT 4/1	103820
• Accessory-Set MT 4 8-pc.	104594

For additional options for this machine, visit our website and search for R 32 (Product Search)

## Specifications

## R 32 Basic

Drilling capacity	mm	32
Spindle nose-to-table surface distance	mm	320 - 860
Machine table dimensions	mm	1.370x700x160
Quill stroke	mm	240
Spindle mount		MK 4
Speed range	1/min	(6) 75 - 1.220
Motor rating main drive	kW	1,5
Overall dimensions (length x width x height)	m	1,41x0,72x1,89
Weight	kg	1.180
Part No.		101522

## Standard Equipment

coolant system, cube table, halogen lights

# KSR 40 Advance

Linear guides for easy handling and stability

- powerful machine for drilling, tapping, countersinking and boring
- large travel ranges and many different machining stations provide maximum setup and machining possibilities
- extremely sturdy construction ensures high accuracy and reliability
- quick and precise tool positioning: hydraulic clamping is released by the push of a button, head easily swivels forward, backward and horizontally



• infinitely variable spindle speed  
• digital drilling depth indicator

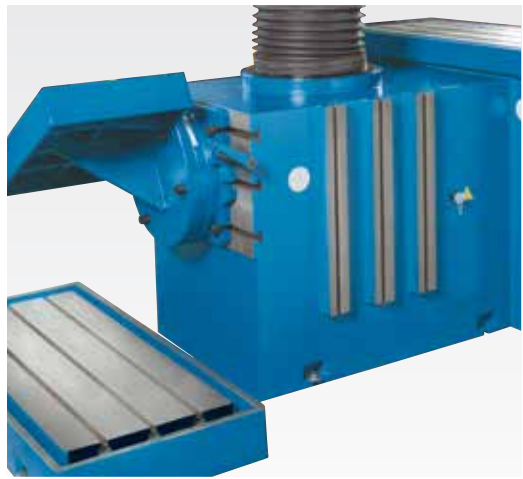

Additional setup areas meets all your requirements

Options	Part No.
• Coolant Concentrate 5 Ltr.	103184
• Universal Facing / Lathe Bore Head ADA / MT 4	103402
• De Luxe Clamping Tool Set 18/M16	105305

For additional options for this machine, visit our website and search for KSR 40 (Product Search)

### Specifications

	KSR 40 Advance	
Drilling capacity	mm	40
Spindle nose-to-table surface distance	mm	780
Quill stroke	mm	200
Table set up area	mm	1.200x505
Spindle mount	MT	4
Spindle speed (infinitely variable)	1/min	50 - 2.000
Motor rating main drive	kW	2,2
Overall dimensions (length x width x height)	m	1,72x1,2x2,25
Weight	kg	2.740
Part No.		162363

### Standard Equipment

digital speed indicator, additional setup areas at the side and rear, cube table, swivelling horizontal table, digital boring depth indicator, work lamp, coolant system, tapping unit, drill chuck with tool-holder bits, reducing sleeves, operating tools, operator manual



See this machine  
in action on  
YouTube 



- Unique operating concept
- Servomotor-driven quill feed
- Large touchscreen
- Rigid design and powerful performance

- Table, column, male die and gear head are made of thick-walled high-grade cast-iron and the entire machine structure features high-quality components and precision machined surfaces
- The large work area can be expanded by mounting optional swivel and angle tables for a wide variety of clamping and machining options



The high-resolution touchscreen features a scratch-resistant surface. Matching rpm and feed speeds for each drill can be recalled from a database and automatically applied.

- The male die features a low-maintenance, very rigid design and runs smoothly in two large linear roller guideways, allowing exact positioning with minimal effort
- The entire machine is extremely smooth running for effortless operation in a production environment
- Column and male die are equipped with hydraulic clamping fixtures
- Main spindle drive with 2 gear steps, infinitely variable speed in each gear step
- For angular bores, the drill head can be rotated 45° in either direction
- A central lubrication system simplifies maintenance

### Electronically controlled servo quill feed

- A servo-motor provides infinitely variable control of the quill feed
- The depth stop is set electronically with a positioning accuracy of +/- 0.1 mm

### Improved functionality and improved layout of the large touchscreen display

- All machine functions are controlled and displayed on the touchscreen
- Measuring units for input and display can be selected by the operator (mm or inch)
- In Thread Cutting Mode, the quill will automatically reverse direction upon reaching the selected thread depth
- Various alarm screens warn the operator in case of operational errors and display information on the operational state
- The control software also provides recommendations for rpm and feed in relation to the desired drill size
- The high-performance coolant system is activated at the touchscreen

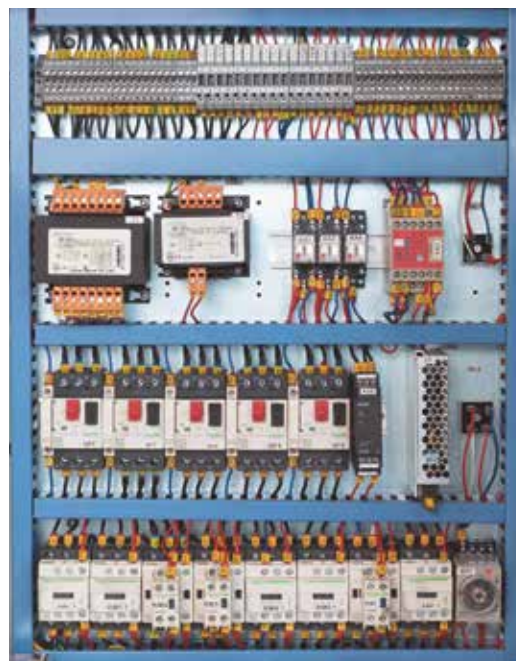

Premium electric components

## Specifications

## KSR 50 VT

Working area		
Drilling capacity	mm	50
Tapping capacity, steel		M 32
Throat	mm	640
Spindle nose-to-table surface distance	mm	760
Head swivel range		± 90°
Column diameter	mm	220
Table set up area	mm	1.200x505
Column stroke	mm	400
Quill stroke	mm	200
Travels		
Upper beam travel	mm	590
Headstock		
Spindle mount	MT	4
Spindle speed (infinitely variable)	1/min	50 - 2.000
Feed		
Feeds	mm/min	(6) 1 - 3.000
Drive capacity		
Motor rating main drive	kW	3
Motor rating height adjustment	kW	1,5
Motor rating feed	kW	1,26
Motor rating hydraulic pump	kW	0,37
Motor rating coolant pump	kW	0,085
Measures and weights		
Overall dimensions (length x width x height)	m	1,72x1,2x2,25
Weight	kg	2.740
Part No.		162365

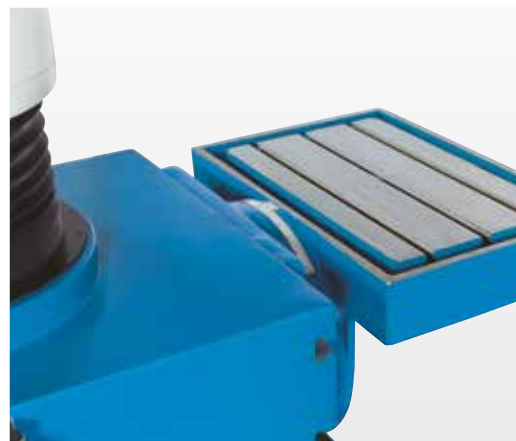

Swivel and angle tables for a wide variety of clamping options

## Standard Equipment

touch screen monitor, additional setup areas at the side and rear, cube table, swivelling horizontal table, work lamp, coolant system, tapping unit, reducing sleeves, operating tools, operator manual

## Options

## Part No.

- |  |        |
|--|--------|
| • Set of collets Ø6-16 mm              | 253672 |
| • Compound Sliding Tables 640 x 205 mm | 253673 |

For additional options for this machine, visit our website and search for KSR 50 VT (Product Search)

- box-column design provides high load capacity, and is torsion-proof and rigid
- table and drill head can be moved individually for an optimum machining height
- 9-step feed and speed gears, with oil-bath lubrication
- high torque across the entire speed range

**Standard Equipment**

coolant system, tapping unit, LED work lamp, operating tools, operator instructions



KSB 63 B is shown



KSB 40 B is shown with optional accessories

**Options**

**Part No.**

• Direct indexing head S 200	110966
• Rotary Table RT 250	125840
• Swivel Table ST 380	129345

For available options for this machine, visit our website and search for KSB (Product Search)

**Specifications**

		<b>KSB 32A</b>	<b>KSB 40B</b>	<b>KSB 50C</b>	<b>KSB 63B</b>
Drilling capacity	mm	32	40	50	63
Throat	mm	280	335	335	375
Quill stroke	mm	200	250	250	250
Spindle nose-to-table distance (max.)	mm	690	650	725	860
Table set up area	mm	400x550	480x560	480x560	650x550
Spindle mount		MK 4	MK 4	MK 5	MK 5
Spindle speed	1/min	(9) 50 - 2.000	(12) 31,5 - 1.400	(9) 45 - 850	(9) 40 - 570
Motor rating main drive	kW	2,2	3	4	5,5
Overall dimensions (length x width x height)	m	0,96x0,85x2,34	1,04x0,91x2,53	1,04x0,91x2,54	0,97x1,45x2,79
Weight	kg	950	1.250	1.250	2.500
Part No.		101692	101693	101694	101695



# SSB 60 F Super VT

Servo-conventional column drill press

- **Ideal for drilling, countersinking, reaming and tapping**
- Heavy construction with thick-walled column
- Large drill press table with circumferential coolant groove and  $\pm 45^\circ$  swivel range
- Table height adjustment via a powerful motorized drive
- Auxiliary gears of main spindle drive run in an oil-bath
- Thread-cutting feature is standard

**Electronically controlled servo quill feed with large touchscreen display**

- The 12.1" color touchscreen conveniently displays all functions and features a rugged, resistant touch panel
- The infinitely variable spindle speed can be controlled at the display and is easy to read
- The system recommends cutting parameters based on bore diameter and material, which also may be accepted automatically
- The depth stop is set electronically at the display
- Drilling depth positioning accuracy is about 0.10 mm
- Easy to program chip breaking function increases process safety

- **High drilling capacity and rigidity**
- **Unique operating concept**
- **Servo motor driven quill feed**
- **Rugged touchscreen with high resolution**
- **Motorized table adjustment**



### Standard Equipment

Touchscreen Bedienfeld, tapping unit, protective shield, coolant system, LED work lamp, operating tools, operator instructions

### Options

Options	Part No.
• Coolant Concentrate 5 Ltr.	103184
• Reduction Sleeve MT 5/3	103840
• Reduction Sleeve MT 5/4	103845
• Drill Press quick-action machine vise with V-guides PBS 200	125007

### Specifications

Specifications	SSB 60 F Super VT	
Drilling capacity	mm	60
Table set up area	mm	600x500
Quill stroke	mm	250
Spindle nose-to-foot distance	mm	1.123
Spindle nose-to-table surface distance	mm	590
Speed range	1/min	50 - 316,316 - 2000
Spindle mount		MK 5
Motor rating main drive	kW	4
Overall dimensions (length x width x height)	m	1,04x0,6x2,27
Weight	kg	950
Part No.		101672

# SSB 40 F Super • 50 F Super VT

Large drilling capacity and easy handling



See this machine  
in action on  
YouTube 

- Ideal for drilling, countersinking, reaming and tapping
- heavy construction with thick-walled column
- large drill press table with circumferential coolant groove, height adjustment, and  $\pm 45^\circ$  swivel range
- table height adjustment via a powerful motorized drive
- 4 automatic drill feeds with electromagnetic clutch control and automatic shut-off when reaching the limit stop

## SSB 50 F Super VT

- Modern operating concept with rugged touchscreen display
- the control system assists the operator with the selection of the correct rpm and feed speed
- the depth stop is set electronically at the display

## Standard Equipment

touchscreen, tapping unit, protective shield, LED work lamp, coolant system, operating tools, operator manual

- motorized table height adjustment
- thread cutting function
- automatic quill feed
- infinitely variable speed



## Specifications

		SSB 40 F Super	SSB 50 F Super VT
Drilling capacity	mm	40	50
Table set up area	mm	540x440	580x460
Quill stroke	mm	190	200
Spindle nose-to-table surface distance	mm	665	590
Spindle nose-to-foot distance	mm	1.195	1.175
Speed range	1/min	60 - 2.600	50 - 2.200
Spindle mount		MK 4	MK 4
Motor rating main drive	kW	2	2,2
Overall dimensions (length x width x height)	m	1x0,65x2,22	1,15x0,68x2,36
Weight	kg	500	650
Part No.		162335	101673



See this machine  
in action on  
YouTube 

- heavy cast-iron construction with thick-walled column
- tapping feature
- automatic drill feeds controlled by an electromagnetic clutch
- includes coolant system and work lamp
- table rotates and swivels  $\pm 45^\circ$

## Standard Equipment

tapping unit, protective shield, LED work lamp, coolant system, operating tools, operator manual

## Options

### Part No.

• Accessory-Set MT 4 8-pc.	104594
• Vise PB 120	104845
• Clamping Tool Set Deluxe 14/M12	105295

For additional options for this machine, visit our website and search for SSB 32 or 40 Xn (Product Search)

### SSB 32 Xn

- head swivels  $50^\circ$ , adjustable height
- digital rpm display



## Specifications

		SSB 32 Xn	SSB 40 Xn
Drilling capacity	mm	32	40
Table set up area	mm	500x420	540x440
Quill stroke	mm	160	190
Spindle nose-to-table distance (max.)	mm	630	610
Spindle mount		MK 4	MK 4
Spindle speed	1/min	(12) 125 - 3.030	(12) 75 - 2.020
Quill feeds	mm/R	0,1; 0,2; 0,3	0,12; 0,24; 0,4
Motor rating main drive	kW	1,2	1,5
Overall dimensions (length x width x height)	m	0,84x0,5x1,96	0,95x0,61x2,23
Weight	kg	540	550
Part No.		162332	162339

- rigid cast-iron construction
- rectangular table with T-slots and circumferential coolant groove
- automatic quill feed
- head swivels  $\pm 45^\circ$  (TSB 35)



See this machine in action on YouTube 



Universal machine base with storage room Part No. 123952



TSB 35 is shown with digital rpm display

## Options

## Part No.

• Oscillation Element LK 3	103330
• Accessory-Set MT 4 8-pc.	104594
• Clamping Tool Set Deluxe 14/M12	105295

For additional options for this machine, visit our website and search for TSB (Product Search)

## Standard Equipment

base, protective shield, tapping unit, LED work lamp, coolant system, drill chuck, operating tools, operator instructions

## Specifications

		TSB 25	TSB 35
Drilling capacity	mm	25	35
Tapping capacity, steel		M 16	M 22
Foot set up area (length x width)	mm	310x320	370x360
Spindle nose-to-foot distance	mm	650	645
Spindle speed	1/min	(6) 125 - 2.825	(12) 125 - 3.030
Spindle mount	MT	3	4
Quill stroke	mm	110	155
Quill feeds	mm/R	-	(3) 0,1; 0,2; 0,3
Motor rating main drive	kW	0,75	1,2
Overall dimensions (length x width x height)	m	0,7x0,41x1,56	0,81x0,5x1,67
Weight	kg	220	340
Part No.		162340	162345



Infinitely variable feed motor

Heavy, precision-ground work table features diagonal T-slots

- Modern design, high-quality cast-iron, and excellent workmanship combined with superior rigidity, function and appearance
- Large base plate with ground setup area and parallel T-slots
- Spindle shank and spindle are hardened and ground
- High-performance coolant system integrated in the machine base

### Electronically Controlled Quill Feed

- The color touchscreen conveniently displays all functions and features a rugged, resistant touch panel
- The spindle speed can be controlled infinitely variable at the display and is easy to read
- The automatic quill feed can also be infinitely adjusted and read at the display
- The depth stop for automatic feed is set mechanically via a robust clamping mechanism

### Standard Equipment

Touchscreen control panel, automatic quill feed, LED work lamp, coolant system, drill chuck, tool-holder bits, drill press vise, tapping unit, operating tools, operator manual



- Automatic feed
- Thread cutting unit
- Integrated coolant system

### Specifications

	KB 32 SFV Pro	
Drilling capacity	mm	32
Tapping capacity, steel		M24
Table set up area	mm	330x330
Quill stroke	mm	15
Spindle nose-to-foot distance	mm	124
Spindle nose-to-table surface distance	mm	820
Speed range	1/min	140 - 2.250
Spindle mount		MT 3
Quill feed	mm/R	24 - 242
Motor rating main drive	kW	1,5
Overall dimensions (length x width x height)	m	0,9x0,6x1,9
Weight	kg	310
Part No.		170464



Touchscreen with comfortable selection of functions, like drilling, thread-cutting, and setup operations (SV and SFV)



KB 20 SV is shown



See this machine in action on YouTube 



KB 32 SFV is shown

- Modern design, high-quality cast-iron, and excellent workmanship combined with superior rigidity, function and appearance
- Heavy, precision-ground work table with diagonal T-slots
- Very smooth height adjustment of drill table, even under high loads
- Large base plate with ground setup area and parallel T-slots
- Forward and reverse, plus automatic reversal of direction for thread cutting
- Spindle shank and spindle are hardened and ground

- Robust belt drive and quiet, powerful motor
- Integrated LED work lamp is standard
- S-series models with digital speed indicator

#### V models:

- Infinitely variable speed adjustment via potentiometer
- Touchscreen with comfortable selection of functions, like drilling, thread-cutting, and setup operations
- The control unit allows querying of all limit switches and shows all functionalities, like coolant system, rpm and work lamp



(S and SV)



KB 20 S is shown



KB 32 SF is shown

#### Standard Equipment

work lamp, coolant system (KB 32), drill chuck, tool-holder bits, drill press vice, tapping unit, operating tools, operator manual

#### Options

for this machine, visit our website and search for KB 20 S or KB 32 SF (Product Search)



Universal machine base with storage room for the KB 20 S / KB 20 SV (Part No. 123952)

#### Specifications

		KB 20 SV	KB 20 S	KB 32 SF	KB 32 SFV
<b>Working area</b>					
Drilling capacity	mm	20	20	32	32
Tapping capacity (max.)		M 16	M 20	M 24	M 24
Table set up area	mm	255x255	255x255	330x330	330x330
Spindle nose-to-table dist.	mm	366	366	813	820
Spindle nose-to-foot distance	mm	678	678	1.236	1.236
Throat	mm	240	240	265	265
Column diameter	mm	85	85	100	100
<b>Headstock</b>					
Speed range	1/min	205 - 2,045	(5) 320 - 1,820	(8) 320 - 1,820	(2) 140 - 2,250
Spindle mount		MK2	MK2	MK3	MK3
Quill stroke	mm	135	135	150	150
<b>Drive capacity</b>					
Motor rating / voltage	kW/V	1,1 / 400	1,1 / 400	1,5 / 400	1,5 / 400
<b>Measures and weights</b>					
Overall dimensions (length x width x height)	m	1x0,56x1,4	0,94x0,49x1,39	1x0,6x2,1	0,9x0,6x1,9
Weight	kg	179	170	345	310
Part No.		170462	170460	170461	170463

# Sawing machines

**See for yourself live:** Many models are in stock or can be viewed and tried out at a user's location near you. Make a demonstration appointment! [info@knuth.com](mailto:info@knuth.com)



## Experience our machines in action!

With our YouTube channel KNUTH Machine Tools, you stay up to date with all the news and developments.



### Fully automatic horizontal bandsaw **ABS**

Cutting capacity, round **280 - 600 mm**

Economically reliable in series saws  
from page 160 onwards



### Horizontal bandsaw **HB**

Cutting capacity, round **150 - 1.020 mm**

Wide range of reliable bandsaws  
in various designs

from page 178 onwards





### Horizontal bandsaw

#### SBS

Cutting capacity, round **235 - 355 mm**

High cutting performance, compact design and quick-action angle adjustment

Page 184



### Workshop bandsaws

#### B

Cutting capacity, round **200 mm**

The economic alternative to bow and circular saws

Page 186



### Cold circular saws

#### KKS

Cutting capacity, round **60 - 120 mm**

Saw blade diameter **250 - 350 mm**

A classic for the workshop - robust and durable

Page 189



### Vertical bandsaw

#### VB

Cutting capacity **300 - 580 mm**

Particularly sturdy design with integrated saw band welding device

Page 188

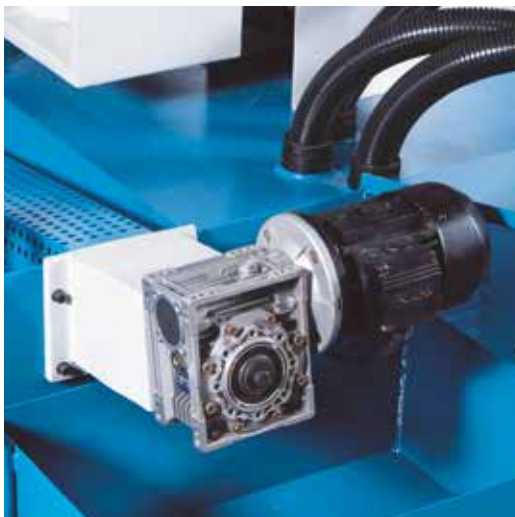
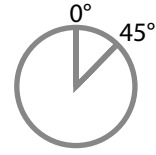

Spiral chip conveyor included in standard equipment

- PLC control
- Cut angle adjustment at 0°, 15°, 30° and 45°
- Large touchscreen display
- Fully automated workpiece feed

- For efficient severing cuts of large diameters this heavy machine provides NC-controlled material feeds
- The robust touchscreen is mounted to a rotating control panel for quick programming and safe handling of the machine
- The machine frame is a torsion-resistant dual-column construction that ensures superior stability and torsional strength



Manual saw frame angle adjustment with hydraulic drive (15°. 30° and 45°)

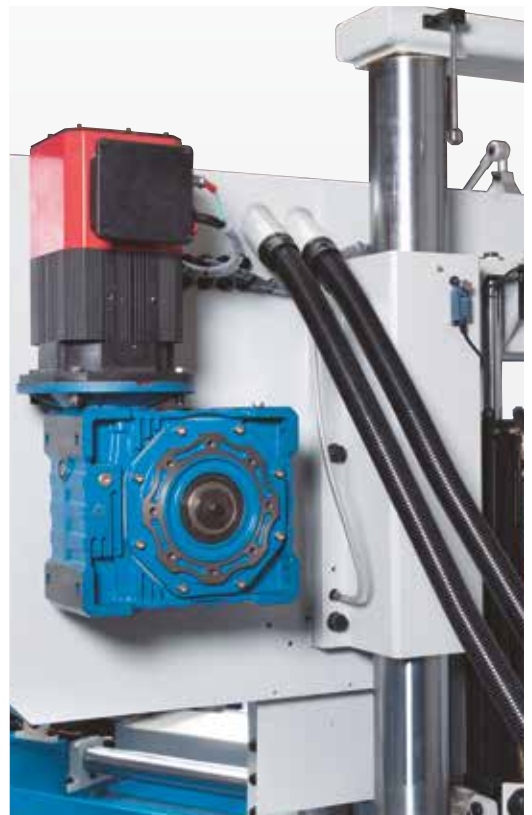

Infinitely variable high-torque servo-motor

- The hydraulically controlled saw frame feed can be infinitely adjusted as needed by the operator
- The hydraulically controlled vise positions the workpiece in the programmed position, while a second vise secures the workpiece precisely in front of the saw blade
- The linear measuring system is mounted at the feed system to ensure precise workpiece dimensions and exact repeatability
- An infinitely variable high-torque servo-motor allows adjustments based on cutting speed



Control panel with graphic touchscreen display

## Specifications

## ABS 600 TNC

### Cutting Capacities

Cutting speed	m/min	0 - 100
Feed per scale division X-axis	mm	600
Cutting capacity 0° (round)	mm	600
Cutting capacity 0° (square)	mm	600
Cutting capacity 0° (flat)	mm	850x600
Cutting capacity 45° (round)	mm	400
Cutting capacity 45° (square)	mm	400
Cutting capacity 45° (flat)	mm	400x600

### Drive capacity

Motor rating main drive	kW	5,5
Motor rating hydraulic pump	kW	1,5
Motor rating coolant pump	kW	0,09

### Measures and weights

Blade dimensions	mm	6.685x54x1,6
Overall dimensions (length x width x height)	m	3,11x3,38x2,35
Weight	kg	3.945
Part No.		152825

## Standard Equipment

PLC control, chip brush, hydraulic vice, bi-metallic band saw blade, touch screen monitor, work lamp, chip conveyor, coolant system, material support, operating tools, operator manual

## Options

## Part No.

• Bimetallic Bandsaw Blade for ABS 600 TNC (3/4 T)	119228
• Bimetallic Bandsaw Blade (4/6 T)	119229

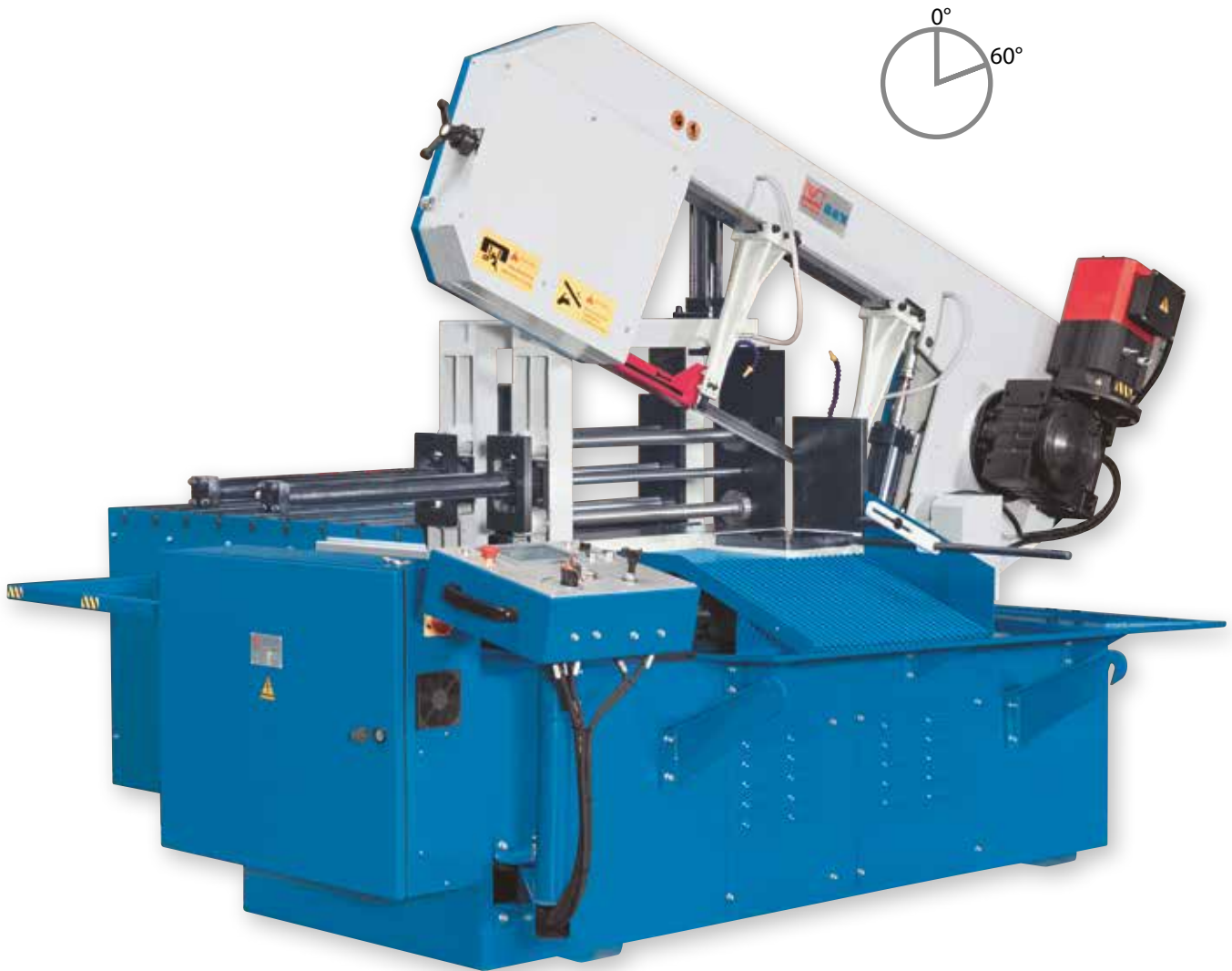

- PLC control
- Cut angle adjustment at 0°, 30°, 45° and 60°
- Large touchscreen display
- Fully automated workpiece feed

- The saw frame can be moved hydraulically by the user for various cutting angles (0°, 30°, 45° and 60°)
- Robust touch screen control panel for easy programming of the cutting task
- Automatic workpiece feed features a precision linear measuring system
- Hydraulic saw frame feed, infinitely variable



Control panel swivels and features an intuitive layout



Dual hydraulic gantry vise ensures maximum stability, even during machining of bundles



Infinitely variable belt speed, servo motor driven

## Specifications

## ABS 460 TNC

### Cutting Capacities

Cutting speed	m/min	23 - 95
Feed per scale division X-axis	mm	650
Working height	mm	850
Cutting capacity 0° (round)	mm	460
Cutting capacity 0° (square)	mm	350
Cutting capacity 0° (flat)	mm	650x350
Cutting capacity 30° (round)	mm	460
Cutting capacity 30° (square)	mm	350
Cutting capacity 30° (flat)	mm	580x350
Cutting capacity 45° (round)	mm	460
Cutting capacity 45° (square)	mm	350
Cutting capacity 45° (flat)	mm	460x350
Cutting capacity 60° (round)	mm	310
Cutting capacity 60° (square)	mm	310
Cutting capacity 60° (flat)	mm	310x350

### Drive capacity

Motor rating main drive	kW	5,5
Motor rating hydraulic pump	kW	1,5
Motor rating coolant pump	kW	0,045

### Measures and weights

Blade dimensions	mm	5.220x41x1,3
Overall dimensions (length x width x height)	m	3,23x2,72x1,77
Weight	kg	2.430
Part No.		152824

- Servo-motor drive provides infinitely variable saw blade cutting speeds and high torque across the entire speed range
- Band speed indicator on the display
- Precise and stable saw band guides ensure high angular accuracy

## Standard Equipment

NC control, hydraulic vice, hydraulic feed vise, bi-metallic band saw blade, touch screen monitor, coolant system, chip brush, material support base with roller, operating tools, operator manual

## Options

## Part No.

• Bimetallic Bandsaw Blade ABS 460 TNC (3/4 T)	119226
• Bimetallic Bandsaw Blade ABS 460 TNC (4/6 T)	119227



See this machine  
in action on  
YouTube

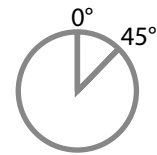

- **Siemens SIMATIC PLC**
- **Autom. cutting angle adjustment**
- **Large touchscreen display**
- **Fully automated workpiece feed**

- Cutting angle settings 0° - 45°
- Robust touch screen control panel
- automatic workpiece feed
- torsion-resistant dual-column construction
- hydraulic saw frame feed via chrome-plated column guide
- slightly inclined saw frame improves cutting performance and increases the service-life

- dual hydraulic workpiece clamping
- infinitely variable cutting speed
- Programmable automatic angle positioner can be set in 1° increments from 0° to 45°
- precise and stable saw band guides ensure high angular accuracy
- automatic band breakage control
- Infinitely variable saw blade speed with settings shown on the display



Both vises are designed as hydraulic bundle vises (standard equipment)



In Auto Mode, feed distance, cut angle, and number of cuts can be programmed within the respective configurations

## Standard Equipment

Siemens PLC control, autom. cleaning brush, feed roller table (2 meters), 1 saw blade, touch screen monitor, automatic parts counter, bundle vise, chip conveyor, coolant system, operating tools, operator manual

Options	Part No.
• E-ABS300NC spare parts package for 152880	259005
• 3 meter roller table for ABS 300 NC	252714
• 2 meter roller table for ABS 300 NC	251909
• Bi-Metallic Bandsaw Blade / ABS 300 NC (5/8 Z")	119212
• Bi-Metallic Bandsaw Blade / ABS 300 NC (4/6 Z")	119211
• Bi-Metallic Bandsaw Blade / ABS 300 NC (3/4 Z")	119210
• Coolant Concentrate 5 Ltr.	103184
• Bi-Metallic Band Saw Blade / ABS 400 L (3-4 Z/Z)	119246
• Bi-Metallic Band Saw Blade / ABS 400 L (4-6 Z/Z)	119247
• Bi-Metallic Band Saw Blade / ABS 400 L (5-8 Z/Z)	119248
• 2 meter roller table for ABS 400 NC	253365

For more information on band saw blades, please visit our website and look for ABS 300 NC and ABS 400 NC (Product Search)

## Specifications

		ABS 300 NC	ABS 400 NC
<b>Cutting capacities</b>			
Feed per scale division X-axis	mm	400	400
Cutting speed	m/min	20 - 90	20 - 80
Cutting capacity 0° - circular / square	mm	300	400
Cutting capacity 0° (flat)	mm	360x300	500x400
Cutting capacity 30° - circular / square	mm	300	400
Cutting capacity 30° (flat)	mm	300x300	400x400
Cutting capacity 45° - flat	mm	240x300	350x400
Cutting capacity 45° - circular / square	mm	240	350
<b>Drive capacity</b>			
Motor rating main drive	kW	3	4
Motor rating hydraulic pump	kW	0,75	0,75
Motor rating coolant pump	kW	0,09	0,09
<b>Measures and weights</b>			
Belt dimensions	mm	4.430x34x1,1	5.590x41x1,1
Overall dimensions (length x width x height)	m	2,2x2x1,7	2,4x2,3x2
Weight	kg	1.900	2.900
Part No.		152880	152883



- Cutting angle adjustment 0° - 45°
- Hydraulic workpiece clamping
- Fully automated workpiece feed
- Touchscreen control panel

- The ABS 350 C is a fully automated horizontal miter band saw for series production of solid materials, tubes and profiles
- In the vise integrated rollers feed the material
- This efficient and cost-effective solution has a proven record, is very robust and provides precise cuts
- The saw frame features excellent stability and vibration-damping characteristics, and can be rotated manually up to 45°
- Very rigid adjustable carbide saw blade guide ensures high vertical angle accuracy



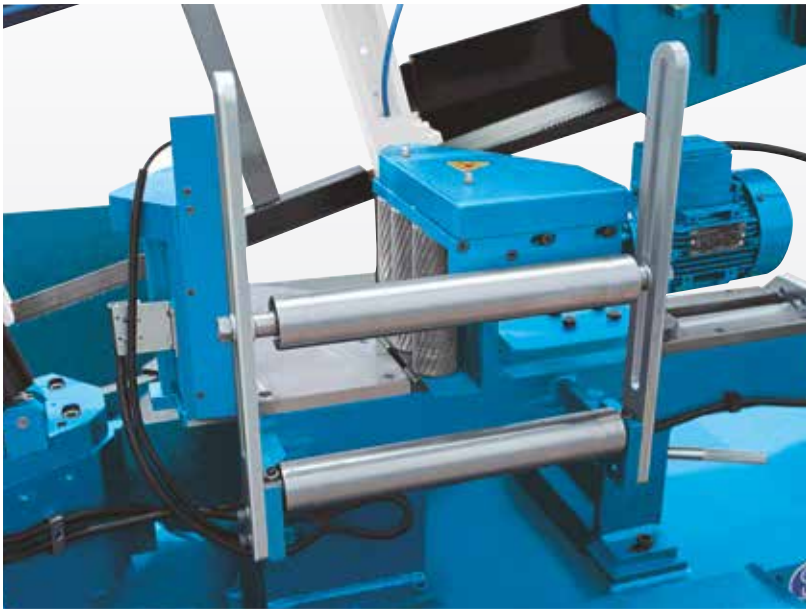

Workpiece bundles can also be processed



The touchscreen allows for easy and convenient programming for fully automated operation

- Saw blade stroke and workpiece clamping are hydraulically driven
- Saw blade feed via micro-adjustable hydraulic valve
- Switches and controls are conveniently arranged on a stand-alone control panel
- A motor with infinitely variable speeds transmits power via a continuous-operation idler gear to the blade drive wheel
- The correct saw blade tension can be checked at the pressure gauge display
- An automatic band breakage control, a high-performance coolant system, and an effective chip brush complement the standard equipment package
- An additional roller conveyor and a Minimal Quantity Lubrication (MQL) system are available as options

### Standard Equipment

automatic band break control, bundle vise, coolant system, hydraulic part clamping, operating tools, saw-band, chip wiper, feed roller table 1,2 m, operator instructions

### Specifications

### ABS 350 C

Cutting Capacities		
Cutting capacity 0° (round)	mm	350
Cutting capacity 0° (flat)	mm	400x350
Cutting capacity 0° (square)	mm	350
Cutting capacity 30° (round)	mm	320
Cutting capacity 30° (flat)	mm	400x350
Cutting capacity 30° (square)	mm	320
Cutting capacity 45° (round)	mm	320
Cutting capacity 45° (flat)	mm	290x300
Cutting capacity 45° (square)	mm	290
Cutting speed	m/min	20 - 100
Drive capacity		
Motor rating main drive	kW	2,2
Motor rating hydraulic pump	kW	0,37
Motor rating coolant pump	kW	0,12
Motor rating feed	kW	0,25
Measures and weights		
Blade dimensions	mm	4.160x34x1,1
Overall dimensions (length x width x height)	m	2,45x0,92x2,02
Weight	kg	1.050
Part No.		152758

### Options

### Part No.

• 3 meter roller table for ABS 350 C	253853
• micro cooling system	253718
• Bi-Metallic Band Saw Blade 3/4 T"	119950
• Bi-Metallic Band Saw Blade 4/6 T"	119951
• Bi-Metallic Band Saw Blade 5/8 T"	119952



ABS 460 L is shown

- torsionally rigid machine frame made of a robust steel construction with high-quality linear guides
- proven material feed system with hardened workpiece guide rollers and hydraulic workpiece clamping
- shorter machining times are made possible by an advanced hydraulic saw frame feed design, including a new pressure control system to master any sawing tasks - infinitely variable setting of feed speed and cutting pressure
- all required settings are accessible and clearly labeled at the second control valve for easy adjustments
- optical registration of the workpiece height allows empty runs in rapid feed mode for an optimum change-over to work feed and limiting of the vertical saw frame travel - everything is automated to reduce operator work load

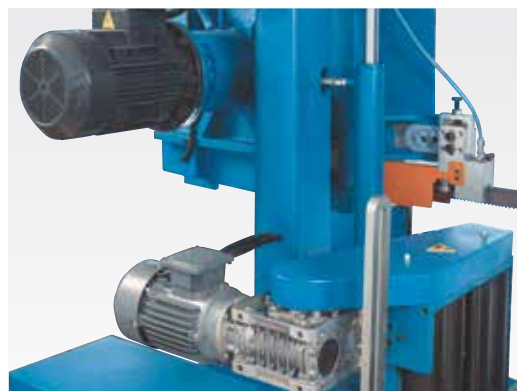

Powerful saw blade/feed motors and heavy-duty gears can handle demanding applications and high loads with quiet operation and minimal space requirement.



Driven feedrate rolls stop automatically when the material



Solid feed roller table and material guide for workpiece bundles

## Standard Equipment

saw-band, workpiece counter, band break control, coolant system, hydraulic clamping, mechanical saw blade tensioning with hydraulic pressure gauge, feed roller table 1,2 m, linear stop, operator instructions

## Options

Options	Part No.
• 3 meter roller table for ABS 460 L	251873
• 3 meter roller table for ABS 380 L	251869
• 3 meter roller table for ABS 330 L	253849
• 3 meter roller table for ABS 560 L	251877

## Bi-Metallic Band Saw Blades

for model	dimensions	teeth/inch
<b>ABS-325 L</b>	4160 x 34 x 1,1	3/4, 4/6, 5/8
<b>ABS-380 L</b>	4800 x 34 x 1,1	3/4, 4/6, 5/8
<b>ABS-460 L</b>	5200 x 41 x 1,3	3/4, 4/6, 5/8
<b>ABS-560 L</b>	6000 x 41 x 1,3	3/4, 4/6, 5/8

For more information on band saw blades, please visit our website and look for ABS L (product search)

## Specifications

		ABS 330 L	ABS 380 L	ABS 460 L	ABS 560 L
<b>Cutting Capacities</b>					
Cutting capacity 0° (flat)	mm	360x330	430x380	470x460	570x560
Cutting capacity 0° (round)	mm	330	380	460	560
Cutting capacity 0° (square)	mm	330	380	460	560
Cutting speed infinitely variable	m/min	20 - 100	20 - 100	20 - 100	20 - 100
Accuracy of the feeding	mm	0,5	0,5	0,5	0,5
<b>Drive capacity</b>					
Motor rating main drive	kW	3	3	4	4
Motor rating hydraulic pump	kW	0,55	0,55	0,55	1,1
Motor rating feed	kW	0,25	0,25	0,25	0,55
<b>Measures and weights</b>					
Overall dimensions (length x width x height)	m	2,75x0,9x1,7	2,9x0,95x1,66	3,1x1x1,8	3,5x1,05x2,05
Weight	kg	1.400	1.250	1.500	2.100
Part No.		152763	152761	152766	152771

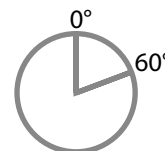

- PLC with graphic touchscreen display
- Manual cut angle adjustment from 0° - 60°
- Fully automated workpiece feed

- Automatic workpiece feed and cutting cycle can be programmed via PLC
- Programming is easy via a user-friendly graphic touchscreen interface
- Input can be in metric or imperial units
- 2-step drive motor for easy saw blade speed adjustments
- Rigid, adjustable saw blade guides can easily be adjusted for different workpiece diameters



PLC with graphic touchscreen

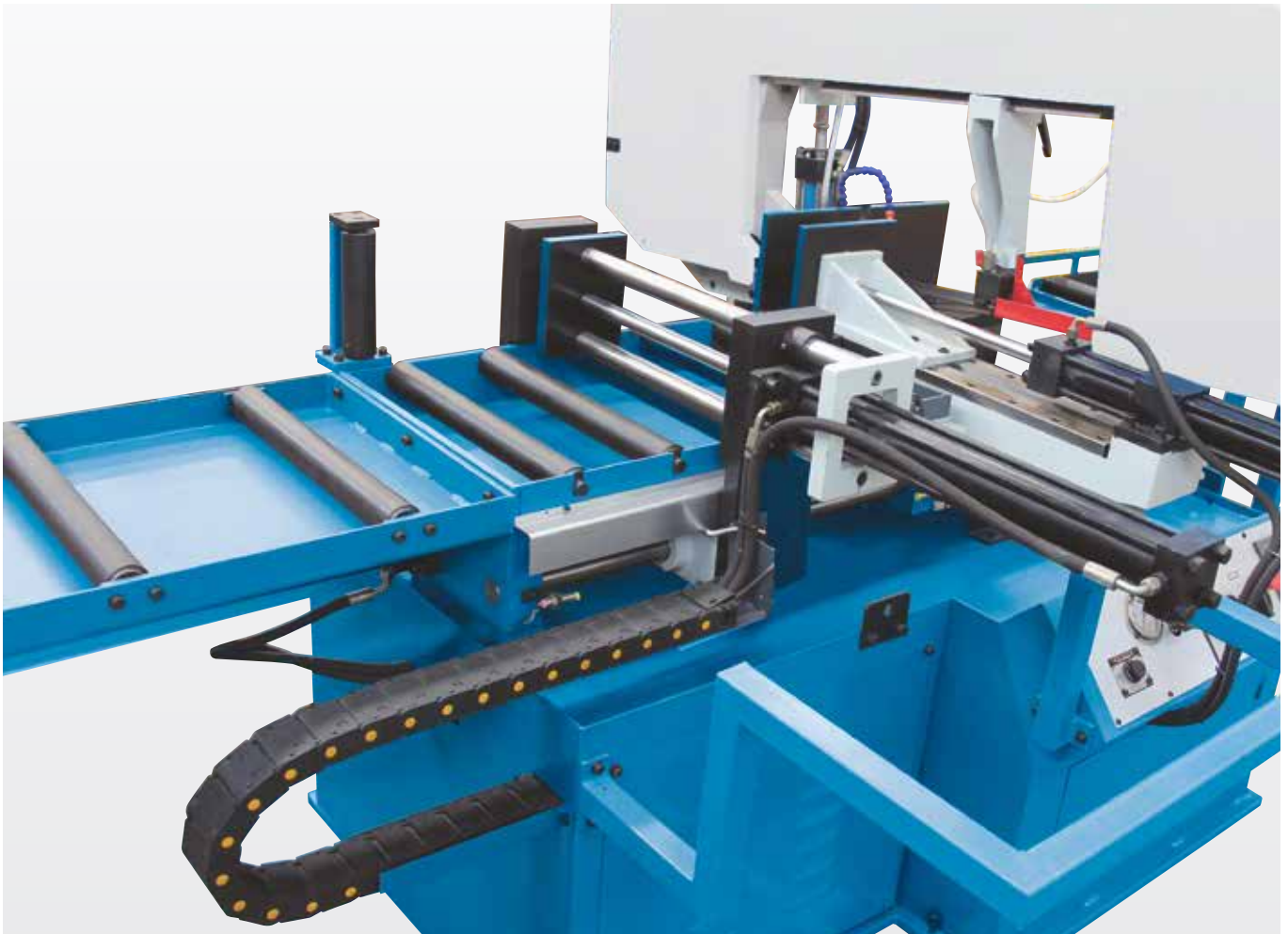

Feed and workpiece clamping via powerful hydraulic vises

## Specifications

## ABS 330 TNC

### Cutting Capacities

Cutting speed	m/min	40/80
Feed per scale division X-axis	mm	500
Working height	mm	850
Cutting capacity 0° (round)	mm	330
Cutting capacity 0° (square)	mm	250
Cutting capacity 0° (flat)	mm	460x250
Cutting capacity 30° (round)	mm	310
Cutting capacity 30° (square)	mm	250
Cutting capacity 30° (flat)	mm	375x250
Cutting capacity 45° (round)	mm	305
Cutting capacity 45° (square)	mm	250
Cutting capacity 45° (flat)	mm	305x250
Cutting capacity 60° (round)	mm	205
Cutting capacity 60° (square)	mm	205
Cutting capacity 60° (flat)	mm	205x250

### Drive capacity

Main motor rating	kW	1,5/2,2
Motor rating hydraulic pump	kW	0,75
Motor rating coolant pump	kW	0,045

### Measures and weights

Blade dimensions	mm	3.960x34x0,9
Overall dimensions (length x width x height)	m	6,47x2,25x1,4
Weight	kg	1.520
Part No.		152820

- Safety during automatic operation is ensured by secure workspace enclosures
- Linear and transverse feed/discharge roller tracks are part of the standard equipment

## Standard Equipment

PLC control, chip brush, Feed roller table (3 meters), Hydraulic workpiece feed, bi-metallic band saw blade, touch screen monitor, coolant system, operating tools, operator manual

## Options

## Part No.

• Bi-Metallic Bandsaw Blade for ABS 330 TNC (3/4 T)	119230
• Bi-Metallic Bandsaw Blade for ABS 330 TNC (4/6 T)	119231
• Bi-Metallic Bandsaw Blade for ABS 330 TNC (5/8 T)	119232

# ABS 320 B

Fully automated for continuous operation - proven reliability, convincing Price and Performance



**Cutting capacity**

- circular: Ø 320mm
- square: 300mm
- rectangular: 320 to 200 mm

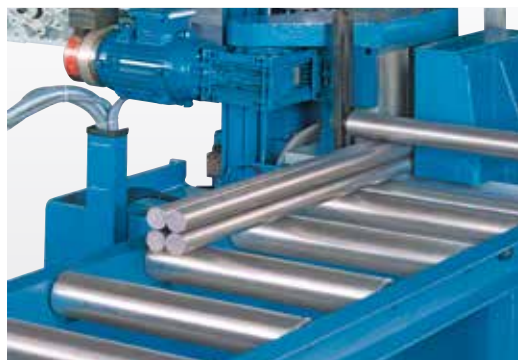

A bundle vise is provided for cutting entire material packs to length

- saw frame and machine bed are made of premium cast-iron for torsion-free performance even under maximum loads
- new helical gears ensure above-average service life and low maintenance
- Saw frame feed and cutting speed are infinitely variable
- Reliable roller feed system with hydraulic workpiece clamping

### Options

	Part No.
• Coolant Concentrate 5 Ltr.	103184
• Bi-Metallic Bandsaw Blade ABS 320 BS (3/4 Z")	119815
• Bi-Metallic Bandsaw Blade ABS 320 BS (5/8 Z")	119816

### Specifications

		ABS 320 B
Cutting capacity - circular	mm	320
Cutting capacity - square	mm	300
Cutting capacity - rectangular	mm	320x200
Cutting speed	m/min	20 - 100
Motor rating main drive	kW	2,25
Blade dimensions	mm	3.660x27x0,9
Weight	kg	660
Part No.		152755

For more information on band saw blades, please visit our website and look for ABS 320 B (Product Search)

### Standard Equipment

automatic band break control, bundle vise, coolant system, operating tools, saw-band, chip wiper, feed roller table 1,2 m, operator instructions

# ABS 280 T

Fully automated dual-column band saw with bundle clamping fixture



- Hydraulic workpiece clamping,
- Fully automated workpiece feed



Automatic workpiece feed and traversing vise with manually adjustable stroke limit stop

- The machine frame is designed as torsion-proof dual-column construction to allow powerful, precise machining with minimal vibration
- The remove cabinet-mounted control panel is user-friendly and provides optimum visibility of the workpiece during machining
- A second non-traversing vise secures the positioned workpiece automatically at the cut line
- Feed and tensioning of the vises are hydraulically controlled

### Options

Options	Part No.
• Bimetallic Bandsaw Blade ABS/HB 280 T (3/4 T)	119233
• Bimetallic Bandsaw Blade ABS/HB 280 T (4/6 T)	119234
• Bimetallic Bandsaw Blade ABS/HB 280 T (5/8 T)	119235

### Specifications

		ABS 280 T
Cutting speed	m/min	27,45,69
Cutting capacity 0° (round)	mm	280
Cutting capacity 0° (square)	mm	280
Cutting capacity 0° (flat)	mm	280x280
Motor rating main drive	kW	3
Blade dimensions	mm	3.505x27x0,9
Weight	kg	1.010
Part No.		152828

### Standard Equipment

1 saw blade, bundle vise, coolant system, work lamp, material support block, operating tools, operator manual



- **Siemens SIMATIC PLC**
- **Fully automated workpiece feed**
- **Cut angle adjustments 0° - 60°**
- **Infinitely variable cutting speed**

- The ABS H NC is a fully automated horizontal band saw series with parallel guiding system, which is ideally suited for series productions with miter cuts in solid materials, tubes, and profiles
- The torsionally rigid guideway frame provides excellent stability and vibration-damping characteristics
- The combination of linear guides and box ways results in low maintenance, long tool life and extreme ruggedness under heavy production conditions
- The saw frame, including guide frame, can be rotated manually up to 60° and fixated in the selected position via a hydraulic clamping device
- The fully automated mode allows miter cut angles up to 45°, and the semi-automatic mode up to 60°.

- The exact miter cut angle can easily be read on a digital display
- A light 3° inclination of the saw frame on the cutting axis will increase cutting capacity and saw blade life
- Rigid high-precision carbide saw blade guides ensure high vertical angular accuracy
- The reliable hydraulic unit provides the drive power for the automatic workpiece feed, and also the controlled clamping force for workpiece clamping
- Hydraulically controlled saw frame micro-feed
- All switches and controls are conveniently arranged on a stand-alone control panel
- The reliable Siemens Simatic KP 400 PLC allows for easy and convenient programming for a fully automated operation





All switches and controls are clearly arranged on a separate control panel

- Unnecessary downtime is reduced by an optically controlled change-over from rapid feed to work feed
- A motor with infinitely variable speeds transmits power via a continuous-operation idler gear to the machine drive wheel
- The correct saw blade tension can be verified directly at the pressure gauge display
- An automatic band breakage control, a high-performance coolant system, and a chip brush complement the standard equipment package
- Available options for this series include Minimal Quantity Lubrication (MQL) and hydraulic bundle clamping

## Standard Equipment

Siemens Simatic KP 400 SPS-control, automatic workpiece feed (hydraulic), hydraulic part clamping, hydraulic clamping of cutting angle, digital angle display, optical height adjustment, saw-band, mechanical saw blade tensioning with hydraulic pressure gauge, saw blade cleaner brush, coolant system, operating tools, operator manual

## Options

## Part No.

• 3 meter roller table for ABS S 360/440 NC / ABS H 360/440 NC	253825
• 3 meter roller table for ABS S 325 NC / ABS H 325 NC	253752
• 3 meter roller table for ABS S 540 NC / ABS H 540 NC	253826
• Bi-Metallic Bandsaw Blade ABS450B/HB450/HB560/ABS560C (3/4 T)	119810
• Bi-Metallic Bandsaw Blade ABS450B/HB450/HB560/ABS560C (4/6 T)	119811

For more information on band saw blades, please visit our website and look for ABS H NC (Product Search)

## Specifications ABS H NC

## 325

## 360

## 440

## 540

### Cutting Capacities

Feed per scale division X-axis	mm	500	500	500	500
Cutting speed	m/min	20 - 100	20 - 100	20 - 100	20 - 100
Cutting capacity 0° (round)	mm	325	360	450	540
Cutting capacity 0° (flat)	mm	400x315	610x360	610x425	670x540
Cutting capacity 0° (square)	mm	315	360	425	540
Cutting capacity 30° (round)	mm	325	360	450	540
Cutting capacity 30° (flat)	mm	380x315	590x360	560x425	670x540
Cutting capacity 30° (square)	mm	315	360	425	540
Cutting capacity 45° (round)	mm	300	360	430	510
Cutting capacity 45° (flat)	mm	300x315	450x360	430x425	450x540
Cutting capacity 45° (square)	mm	300	360	425	450

### Cutting capacity in semi-automatic mode

Cutting capacity 60° (round)	mm	200	325	320	270
Cutting capacity 60° (flat)	mm	200x315	280x360	260x425	250x540
Cutting capacity 60° (square)	mm	200	290	290	250

### Drive capacity

Motor rating main drive	kW	2,2	3	4	4
Motor rating hydraulic pump	kW	1,5	1,5	2,2	1,1
Motor rating coolant pump	kW	0,12	0,12	0,12	0,12

### Measures and weights

Blade dimensions	mm	4.380x34x1,1	5.200x34x1,1	5.400x41x1,3	6.000x41x1,3
Overall dimensions (length x width x height)	m	2,13x2,15x1,65	2,85x2,1x1,82	2,85x2,1x1,95	3,1x2,35x2,15
Weight	kg	1.860	2.400	2.480	3.850
Part No.		152833	152834	152835	152836



ABS 540 S NC - shown with option

- **Omron control with touchscreen**
- **Workpiece feed with preloaded ball screws and servo motor**
- **Cut angle adjustments 0° - 60°**
- **Infinitely adjustable cutting speed**

- The ABS S NC is a fully automated horizontal band saw series with parallel guiding system, which is ideally suited for series production with miter cuts in solid materials, tubes, and profiles
- The workpiece feed with servo motor drive and preloaded ball screws deliver maximum precision
- The combination of linear guides and box ways result in low maintenance, long tool life and extreme ruggedness under heavy production conditions
- The saw frame, including guide frame, can be rotated manually up to 60° and fixed in the selected position via a hydraulic clamping device
- The fully automated mode allows miter cut angles up to 45°, and the semi-automatic mode up to 60°

- The exact saw frame angle can easily be checked by the operator on a digital display
- A slight 3° inclination of the saw frame on the cutting axis increases cutting capacity and saw blade life
- rigid saw blade guides ensure vertical angular accuracy
- the reliable hydraulic unit provides the controlled clamping force for workpiece clamping
- Hydraulically controlled saw frame micro-feed
- The reliable Omron control with touchscreen allows for easy and convenient programming for a fully automated operation
- Unnecessary downtime is reduced by an optically controlled change-over from rapid feed to work feed
- A motor with infinitely variable speeds transmits power via a continuous-operation idler gear to the machine drive wheel
- The correct saw blade tension can be verified

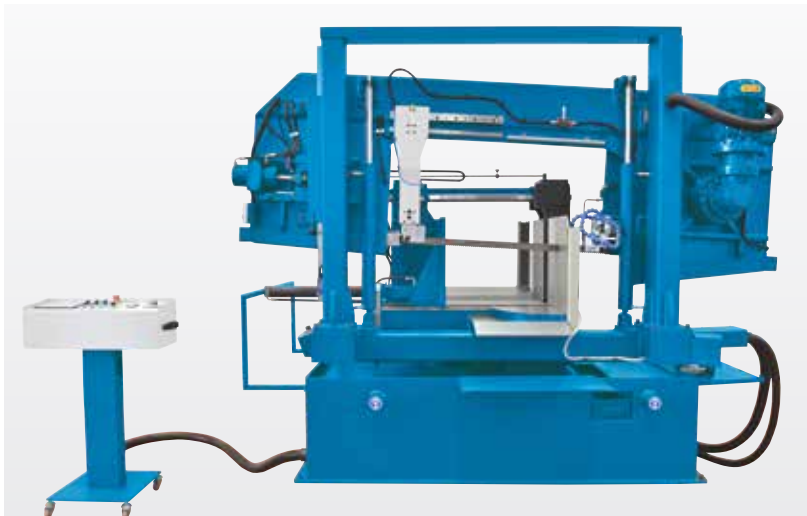

The torsionally rigid guideway frame provides excellent stability and vibration-damping characteristics

- directly at the pressure gauge display
- An automatic band breakage control, a high-performance coolant system, and a chip brush complement the standard equipment package
- Available options for this series include Minimal Quantity Lubrication (MQL) and hydraulic bundle clamping

### Standard Equipment

Omron Steuerung mit Touchscreen, automatischer Werkstückvorschub (servo), hydraulic part clamping, hydraulic clamping of cutting angle, digital angle display, optical height adjustment, saw-band, mechanical saw blade tensioning with hydraulic pressure gauge, saw blade cleaner brush, coolant system, operating tools, operator manual



All switches and controls are conveniently arranged on a stand-alone control panel

Options	Part No.
• 3 meter roller table for ABS S 360/440 NC / ABS H 360/440 NC	253825
• 3 meter roller table for ABS S 325 NC / ABS H 325 NC	253752
• 3 meter roller table for ABS S 540 NC / ABS H 540 NC	253826
• hydraulic top clamping	253717
• Clamping force controlled at operator panel	253808
• Saw blade progress monitor	253809

For additional options for this machine, visit our website.

Specifications ABS S NC		325	360	440	540
<b>Cutting Capacities</b>					
Feed per scale division X-axis	mm	700	700	700	700
Cutting speed	m/min	20 - 100	20 - 100	20 - 100	20 - 100
Cutting capacity 0° (round)	mm	325	360	450	540
Cutting capacity 0° (flat)	mm	400x315	610x360	610x425	670x540
Cutting capacity 0° (square)	mm	315	360	425	540
Cutting capacity 30° (round)	mm	325	360	450	540
Cutting capacity 30° (flat)	mm	380x315	590x360	560x425	670x540
Cutting capacity 30° (square)	mm	315	360	425	540
Cutting capacity 45° (round)	mm	300	360	430	510
Cutting capacity 45° (flat)	mm	300x315	450x360	430x425	450x540
Cutting capacity 45° (square)	mm	300	360	425	450
<b>Cutting capacity in semi-automatic mode</b>					
Cutting capacity 60° (round)	mm	200	325	320	270
Cutting capacity 60° (flat)	mm	200x315	280x360	260x425	250x540
Cutting capacity 60° (square)	mm	200	290	290	250
<b>Drive capacity</b>					
Motor rating main drive	kW	2,2	3	4	4
Motor rating hydraulic pump	kW	1,1	1,1	1,1	2,2
Motor rating coolant pump	kW	0,12	0,12	0,12	0,12
<b>Measures and weights</b>					
Blade dimensions	mm	4.380x34x1,1	5.200x34x1,1	5.400x41x1,3	6.000x41x1,3
Overall dimensions (length x width x height)	m	2,13x2,15x1,65	2,85x2,25x1,87	2,85x2,35x2	3x2,42x2,25
Weight	kg	1.860	2.400	2.480	4.190
Part No.		152840	152841	152842	152843

- saw frame swivels allowing universal angle setting - no need to rotate the workpiece!
- including feed roller stand, 1.2 m long
- automatic lifting of the bandsaw with switching device for variable workpiece sizes



HB 320 BS with swiveling sawframe (60°) and feed roller table

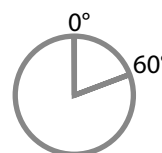

The cutting angle is precisely adjustable and can be easily read

### Options

Options	Part No.
• 3 meter roller table for HB 320 BS	251893
• 3m Roller table w. length stopper & digital readout for HB320BS	257413
• 6m Roller table w. length stopper & digital readout for HB320BS	257414
• Saw Blade / HB 320 BS (6/10 T")	119803
• Bi-Metallic Band Saw Blade 3/4 T"	119950
• hydraulic top clamping for HB 320 BS	251891
• Micro cooling system for HB 320 BS	251892

For more information on saw blades, visit our website

### Specifications

		HB 320 BS
Cutting capacity 0° (round)	mm	320
Cutting capacity 0° (square)	mm	320
Cutting capacity 0° (flat)	mm	610x320
Cutting capacity 45° (round)	mm	320
Cutting capacity 45° (square)	mm	320
Cutting capacity 45° (flat)	mm	355x320
Cutting capacity 60° (round)	mm	260
Cutting capacity 60° (square)	mm	225
Cutting capacity 60° (flat)	mm	280x200
Cutting speed infinitely variable	m/min	20 - 100
Motor rating main drive	kW	2,2
Blade dimensions	mm	4.160x34x1,1
Weight	kg	1.000
Part No.		152798

### Standard Equipment

part clamping, coolant system, linear stop, feed roller table 1,2 m, roller table, operator manual

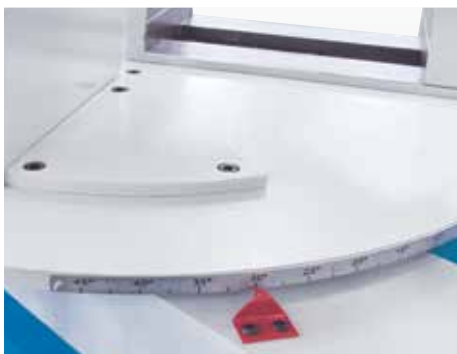

Precise positioning of the saw blade at any desired angle from 0° to 45°, using an easy-to-read scale.



Rotating saw frame with dual-column guide

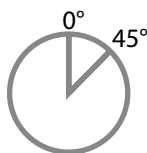

- Cutting angle adjustment 0° - 45°
- Hydraulic workpiece clamping

- The machine frame is designed as a torsion-resistant dual-column construction for maximum stability and accuracy
- A user-friendly control panel with intuitive user controls is integrated into the control cabinet
- Hydraulically controlled saw blade feed allows exact feed adjustments
- At the end of each sawing cycle, the saw blade frame will return to the home position

Options	Part No.
• Bi-Metallic Bandsaw Blade (3/4 T)	119236
• Bi-Metallic Bandsaw Blade (4/6 T)	119237
• Bi-Metallic Bandsaw Blade (5/8 T)	119238

### Specifications

		HB 280 TG
Cutting speed	m/min	27, 45, 69
Cutting capacity 0° (round)	mm	280
Cutting capacity 0° (square)	mm	280
Cutting capacity 0° (flat)	mm	320x280
Cutting capacity 30° (round)	mm	260
Cutting capacity 30° (square)	mm	260
Cutting capacity 30° (flat)	mm	260x280
Cutting capacity 45° - round	mm	170
Cutting capacity 45° - square	mm	170
Cutting capacity 45° - flat	mm	170x280
Motor rating main drive	kW	3
Blade dimensions	mm	3.625x0,9x27
Weight	kg	820
Part No.		152827

### Standard Equipment

bimetallic band saw blade, hydraulic vice, work lamp, coolant system, material support base with roller, operating tools, operator manual



**With linear guide technology!**

- Torsion-proof steel construction with dual-column guide – rigid and vibration absorbing
- The saw frame features a mono-frame design for travel across large linear guides
- Advanced hydraulic saw frame feed with new pressure regulating system (PAS) allows optimum adjustment for every sawing task: infinitely variable feed speed and cutting power control provide a wide spectrum of machining possibilities with just one saw blade type
- Hydraulic saw blade tensioning (HB 810 L and 1020 L)
- You can find an optional roller conveyor on our website

### Standard Equipment

feed roller table 1 m, bimetallic band saw blade, hydraulic part clamping, hydraulic sawblade tensioning (HB 810 L / 1020 L), input / output rollers, automatic stroke height adjustment, automatic stroke height adjustment, coolant system, infinitely variable cutting speed, operator instructions

### Specifications

		HB 380 L	HB 460 L	HB 560 L	HB 810 L	HB 1020 L
Cutting capacity 0° (round)	mm	380	460	560	810	1.020
Cutting capacity 0° (square)	mm	380	460	560	810	1.020
Cutting capacity 0° (flat)	mm	520x380	650x460	750x550	810x850	1.020x1.020
Cutting capacity 45° (round)	mm	300	380	410	810	675
Cutting capacity 45° (square)	mm	300	380	410	810	675
Cutting capacity 45° (flat)	mm	300x380	380x460	410x550	480x850	675x1.020
Cutting speed	m/min	20 - 100	20 - 100	20 - 100	20 - 100	20 - 100
Motor rating main drive	kW	3	4	4	4	7,5
Blade dimensions	mm	4.800x34x1,1	5.200x41x1,3	6.000x41x1,3	8.200x41x1,3	9.500x54x1,6
Weight	kg	1.150	1.410	1.750	2.300	5.860
Part No.		152802	152806	152811	152816	152808

# HB 300 PLC

Band saw with touchscreen and hydraulic workpiece clamping



- Large touchscreen display
- Hydraulic workpiece clamping



Roller support for easy material advancement

- Rigid saw frame and rugged column guide ensure high precision and angular accuracy
- User-friendly control panel with rugged touchscreen
- Hydraulically controlled saw frame feed via generously spaced column guide
- Hydraulic vise ensures secure hold during cutting cycle

## Options

Options	Part No.
• Bimetallic Bandsaw Blade for HB 300 PLC (3/4 T)	119223
• Bimetallic Bandsaw Blade for HB 300 PLC (4/6 T)	119224
• Bimetallic Bandsaw Blade for HB 300 PLC (5/8 T)	119225

## Specifications

		HB 300 PLC
Cutting speed	m/min	30, 50, 75, 90
Cutting capacity 0° (round)	mm	300
Cutting capacity 0° (square)	mm	300
Cutting capacity 0° (flat)	mm	500x300
Motor rating main drive	kW	3
Blade dimensions	mm	4.180x34x1,1
Weight	kg	1.085
Part No.		152823

## Standard Equipment

bimetallic band saw blade, touch screen monitor, hydraulic vise, coolant system, work lamp, material support base with roller, operating tools, operator manual



Material support base, only for HB 280 T

- The torsion-resistant dual-column construction and rigid, heavy cast-iron frame ensure minimal vibration
- Hydraulically controlled saw frame feed
- At the end of the cutting cycle, the machine automatically shuts off and the saw blade returns to its adjustable home position
- Coolant system and material support base are part of the standard equipment



HB 280 T is shown

- Hydraulic workpiece clamping,
- Dual-column construction

Options	Part No.
• Bimetallic Bandsaw Blade HB 400 T (3/4 T)	119239
• Bimetallic Bandsaw Blade HB 400 T (4/6 T)	119240

### Standard Equipment

bimetallic band saw blade, support with roller (HB 280 T), support rollers (HB 400 T), coolant system, work lamp, operating tools, operator manual

For more information on saw blades, visit our website

Specifications		HB 280 T	HB 400 T
Cutting speed	m/min	27, 45, 69	36, 56
Cutting capacity 0° (round)	mm	280	400
Cutting capacity 0° (square)	mm	280	400
Cutting capacity 0° (flat)	mm	280x280	400x400
Main motor rating	kW	3	3/4
Blade dimensions	mm	3.505x27x0,9	5.000x41x1,3
Weight	kg	695	1.325
Part No.		152826	152821



# HB 280 B

Highly reliable Horizontal Band Saws with easy miter adjustment

- infinitely variable hydraulic saw advance ensures optimum cutting results and minimized tool wear
- automatic shut-off upon completion of saw process
- band break sensor activates automatic shut-off upon band break

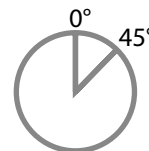

Easily accessible cooling tank with large chip protection screen

### Standard Equipment

part clamping, coolant system, linear stop, roller table, operator manual

### Options

	Part No.
• 3 meter roller table for HB 280 B	251881
• 3m Roller table w. length stopper & digital readout for HB 280B	257411
• 6m Roller table w. length stopper & digital readout for HB 280B	257412
• Saw Blade / HB/ABS 280 B (6 T/')	109350
• Saw Blade / HB/ABS 280 B (10 T/')	109352
• Saw Blade / HB/ABS 280 B (14 T/')	109354

### Specifications

		HB 280 B
Cutting capacity 0° (round)	mm	280
Cutting capacity 0° (square)	mm	280
Cutting capacity 0° (flat)	mm	350x200
Cutting capacity 45° (round)	mm	240
Cutting capacity 45° (square)	mm	210
Cutting capacity 45° (flat)	mm	240x180
Cutting speed infinitely variable	m/min	20 - 100
Motor rating main drive	kW	1,5
Blade dimensions	mm	3.400x27x0,9
Weight	kg	530
Part No.		152797

For more information on saw blades, visit our website



SBS 255 is shown

### SBS 235 / 255

- 2 saw blade speeds, selectable at the drive motor
- Mechanical quick-action clamping allows for quick release and fixation of workpieces via hand-lever; ideal for small batches
- The SBS 255 features a round setup table, which pivots in synchrony with the saw frame

### Standard Equipment

1 saw blade, coolant system, base, pressure gauge for saw blade tensioning, hydraulic cylinder for saw frame, inverter for infinitely variable saw blade speed (SBS 355), hydraulic workpiece clamping (SBS 355), operator instructions

### Options

Options	Part No.
• Bi-Metal Bandsaw blade (3/4 T/")	119155
• Bi-Metal Bandsaw blade (4/6 T/")	119156
• Bi-Metal Bandsaw blade (5/8 T/")	119157

For more information on saw blades, visit our website

### Specifications

		SBS 235	SBS 255	SBS 355
Cutting capacity 0° (round)	mm	225	255	355
Cutting capacity 0° (flat)	mm	150x245	315x230	300x530
Cutting capacity 45° (flat) L	mm	145x190	160x160	270x270
Cutting capacity 45° (flat) R	mm	120x120	195x230	290x360
Cutting capacity 60° R (flat)	mm	90x115	115x160	170x240
Cutting speed	m/min	45 / 90	45 / 90	20 - 80 (infinitely var.)
Motor rating main drive	kW	1,1	1,5	2,2
Weight	kg	295	380	805
Part No.		152778	152786	152788

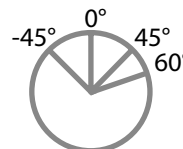

SBS 355 is shown



See this machine  
in action on  
YouTube



### SBS 355

- Hydraulic quick-action clamping fixture with proven performance in series production ensures constant tension to the last cut
- Infinitely variable saw blade speed for optimum machining of a wide range of materials and profiles
- Easy handling - at the end of the cut, the integrated hydraulics lift the saw frame to the home position



HB 210 A



HB 150



HB 250 A

Specifications HB		150	210 A	250 A
<b>Cutting Capacities</b>				
Cutting capacity 0° (round)	mm	150	170	225
Cutting capacity 0° (flat)	mm	120x200	140x200	245x190
Cutting capacity 45° (flat)	mm	90x130	95x130	210x155
Cutting capacity 45° (round)	mm	120	125	155
Belt speed	m/min	40 / 80	40 / 80	40 / 90
Cutting capacity 60° - round	mm	-	-	90
<b>Drive capacity</b>				
Main motor rating	kW	0,6/0,85	0,75	1,1
<b>Measures and weights</b>				
Overall dimensions	m	1,16x0,71x0,79	1,3x0,58x0,88	1,36x0,58x0,9
Weight	kg	135	152	185
Part No.		152822	152850	152796

- cast-iron saw frame, one-piece construction
- for miter cuts, the operator moves the saw frame - not the material
- Hydraulic cylinder provides for infinitely variable support pressure and saw frame feed (HB 210 A / HB 250 A)
- vise with quick-action clamping feature

### Standard Equipment

1 saw blade, coolant system, base, quick-action vise, hydraulic cylinder for saw frame (HB 210 A / HB 250 A), operator manual

### Bi-metallic saw blades

for model	Dimensions in mm	Teeth/inch
<b>HB 150</b>	2060 x 20 x 0,90	4/6, 5/8
<b>HB 210 A</b>	2080 x 20 x 0,80	5/8, 10/14
<b>HB 250 A</b>	2480 x 27 x 0,90	5/8, 8/12

For more information on band saw blades, please visit our website and look for HB 150, HB 210 A or HB 250 A (Product Search)

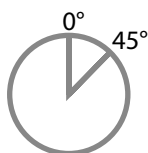

- saw frame swivels - allowing angular cuts to 45°
- coolant system is included
- thin saw blade for reduced material removal
- exact cuts - rigid construction prevents belt track deviations
- quiet, low-vibration operation
- a hydraulic cylinder controls the support pressure infinitely from 0 to maximum pressure

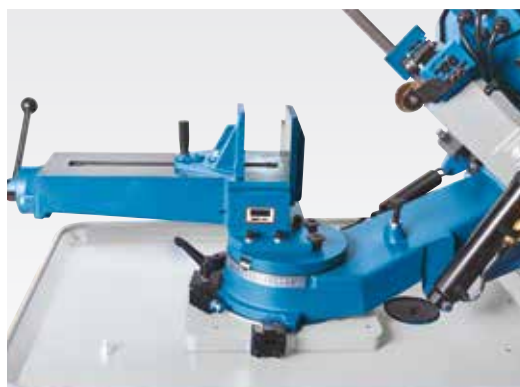

Minimum downtime: allows precise adjustment of angular stops, including quick-action clamps at the vise

### Options

### Part No.

• Bi-Metallic Bandsaw Blade (4/6 T")	119150
• Bi-Metallic Bandsaw Blade (5/8 Z")	119774
• Bi-Metallic Bandsaw Blade (10/14 Z")	119775

For more information on band saw blades, please visit our website and look for B 200 S (Product Search)

### Specifications

### B 200 S

#### Cutting Capacities

Cutting capacity 0° (round)	mm	205
Cutting capacity 0° (square)	mm	205
Cutting capacity 0° (flat)	mm	205x215
Cutting capacity 45° (square) L	mm	115
Cutting capacity 45° (round) L	mm	135
Cutting capacity 45° (flat) L	mm	205x115
Belt speed	m/min	24 / 41 / 61 / 82

#### Drive capacity

Motor rating main drive	kW	1,1
-------------------------	----	-----

#### Measures and weights

Blade dimensions	mm	2.360x20x0,9
Overall dimensions (length x width x height)	m	1,23x0,65x1,32
Weight	kg	190
Part No.		102752

### Standard Equipment

coolant system, quick-action vise, mobile base, saw-band, operator instructions

# Roller Conveyor

Accessories for band saws series HB-A / SBS



- Steel frame made of U-profiles, bolted cross travels
- Steel support rollers with bearings for smooth movement
- The U-profile is designed to ensure friction-free, smooth material flow, even with lateral projections
- Material discharge roller track with adjustable linear stop
- Sturdy supports with wide adjustment range
- Mounting plate, standard

Easy to read scales for exact cut length settings



## Specifications

		Infeed 1000 mm	Outfeed 1000 mm	Infeed 2000 mm	Outfeed 2000 mm	Infeed 3000 mm	Outfeed 3000 mm
<b>Working area</b>							
Roller width	mm	360	360	360	360	360	360
Distance between rollers	mm	300	300	280	280	265	265
Max. load capacity	kg	600	600	1.200	1.200	1.800	1.800
Number of supports	positions	4	4	4	4	6	6
Adjustable height	mm	620 - 1.030	620 - 1.030	620 - 1.030	620 - 1.030	620 - 1.030	620 - 1.030
<b>Measures and weights</b>							
Overall dimensions (length x width x height)	mm	1.000x450 x1.030	1.300x465 x1.030	2.000x450 x1.030	2.300x465 x1.030	3.000x450 x1.030	3.300x465 x1.030
Weight	kg	40	43	55	60	70	76
Part No.		170360	170363	170361	170364	170362	170365



VB 300A

- The machine frame features a torsionally rigid steel construction for a robust and sturdy design
- Functional and practical design, plus easy handling are common features of this entire series
- The support table swivels to the right and left for angled cuts
- The saw blade speed is controlled electronically and shown on a large digital display



The particularly stable guidance of the deflection wheel guarantees its permanent precise alignment and thus increases the cutting performance and service life of the band saw blades

### Standard Equipment

saw blade welder assembly, blade cutting unit, work lamp, saw-band, coolant system, adjustable material stop for table, operator instructions

### Options

### Part No.

• Saw blade VB 585 A (10 Z")	119706
• Saw blade VB 585 A (14 Z")	119707
• Saw blade VB 585 A (24 Z")	119708

For more information on saw blades, visit our website

### Specifications

		VB 300 A	VB 400 A	VB 500 A	VB 585 A
Table dimensions	mm	500x400x890	600x550x970	700x660x980	700x660x1.002
Table with angle adjustment (l/r)	deg	15/45	15/45	15/30	15/30
Cutting capacity height x throat	mm	185x310	285x400	310x500	336x585
Cutting speed	m/min	0 - 190	0 - 257	0 - 329	0 - 340
Motor rating main drive	kW	0,55	1,5	1,5	1,5
Overall dimensions (length x width x height)	m	0,91x0,82x1,6	1,05x0,92x1,82	1,25x1,04x1,98	1,33x1,06x2,11
Weight	kg	275	315	410	555
Part No.		102640	102641	102642	102643

- Easy operation, rugged design, and precise angular cuts make this circular cold saw a "must-have" basic for any workshop
- The models KKS 250 and 275 T provide a rigid vise with quick-action clamping feature and are ideal for small batch productions
- KKS 315 T / KKS 350 T feature a self-centering dual vise that hold the workpiece firmly on both sides of the saw blade
- The miter can be adjusted up to +/- 45 degrees by rotating the gear head
- All models have high-torque motors, and the KKS 315 and 350 T also have reversible poles and 2 speeds
- An integrated coolant system is part of the standard equipment on all models

KKS 315 T is shown

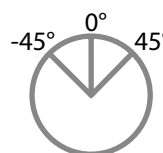

Dual vise (KKS 315 / 350 T)

## Standard Equipment

self centering double vise (KKS 315 / 350 T), quick-action vise (KKS 250 / 275 T), base, coolant system, 1 saw blade, linear stop

## Options

### Part No.

• Circular Saw Blade / KKS 250 (pitch 6)	109802
• Circular Saw Blade / KKS 315 (pitch 6)	109808
• Circular Saw Blade / KKS 350 (pitch 5)	109809
• Circular Saw Blade / KKS 275 (pitch 6)	109810

## Specifications

		KKS 250 T	KKS 275 T	KKS 315 T	KKS 350 T
<b>Working area</b>					
Max. saw blade diameter	mm	250	275	315	350
Shaft diameter	mm	32	32	40	32
Speed	1/min	42	42	18/36	18/36
Width of vise	mm	100	100	145	145
Working height	mm	960	960	960	960
<b>Cutting capacities</b>					
Cutting capacity 0° - round	mm	60	70	100	120
Cutting capacity 0° - square	mm	55	65	100	110
Cutting capacity 0° - flat	mm	75x45	90x45	140x90	140x100
Cutting capacity 45° (round) L	mm	55	65	90	105
Cutting capacity 45° (square) L	mm	50	60	90	100
Cutting capacity 45° (flat) L	mm	55x45	70x45	100x90	100x100
Cutting capacity 45° (round) R	mm	55	65	90	105
Cutting capacity 45° (square) R	mm	50	60	90	100
Cutting capacity 45° (flat) R	mm	55x45	70x45	100x90	100x100
<b>Drive capacity</b>					
Main motor rating	kW	1,1	1,1	0,75 / 1,3	0,75 / 1,3
Supply voltage	V	400	400	400	400
<b>Measures and weights</b>					
Overall dimensions (length x width x height)	m	0,92x0,48x1,71	0,92x0,48x1,78	0,92x0,56x1,78	0,97x0,56x1,83
Weight	kg	143	148	227	236
Part No.		102119	102118	102120	102121

# Grinding machines

**See for yourself live:** Many models are in stock or can be viewed and tried out at a user's location near you. Make a demonstration appointment! [info@knuth.com](mailto:info@knuth.com)



## Experience our machines in action!

With our YouTube channel KNUTH Machine Tools, you stay up to date with all the news and developments.



Conventional circular grinding machine

### RSM C

Grinding length **750 - 2.000 mm**  
Grinding disc dimension **400 - 500 mm**

External and internal grinding with automatic infeed

Page 192 / 193



Conventional circular grinding machine

### RSM A

Grinding length **500 - 800 mm**  
Grinding disc dimensions **400 x 50 x 203 mm**

For external and internal grinding of cylindrical and conical workpieces

Page 194 / 195



Circular and tool grinding machine

### Multi-Grind - Universal grinding machine

Grinding length **500 mm**  
Grinding disc dimensions **200 x 20 x 75 mm**

Ideal for tool and mold design, mechanical manufacturing, development, laboratory and training

Page 204 / 205







NC flat grinding machine

### HFS NC

Grinding length **520 - 1.700 mm**  
Grinding disc dimension **255 - 400 mm**

Automatic and semi-automatic grinding with dressing cycle

Page 198 / 199

NC flat grinding machine

### HFS F NC

Grinding length **1.000 - 3.000 mm**  
Grinding disc dimension  
**355 - 500 mm**

Easily programmable grinding precision for large and heavy workpieces

Page 196 / 197



NC flat grinding machine

### HFS F Advance

Grinding length **560 - 1.130 mm**  
Grinding disc dimension **200 - 355 mm**

Compact series with NC control

Page 200 / 201



Manual flat grinding machine

### FSM 480

Grinding length **480 mm**  
Grinding disc dimensions **200 x 13 x 32 mm**

Compact manual workshop flat grinding machine

Page 202 / 203

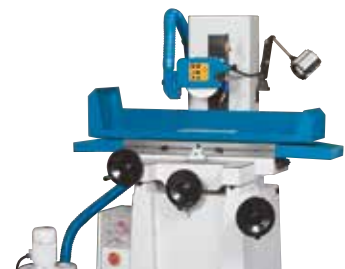

## Grinding devices and edge millers

Stylus grinding machines, edge milling devices, bench grinders and belt-disc grinders

from page 206 onwards





See this machine  
in action on  
YouTube 



RSM 1000 C incl. position indicator is shown

- Extra heavy, wide machine bed with heavy ribbing and one-piece mono-block construction
- Induction-hardened and ground guide slots ensure long-term accuracy and minimum wear
- Massive headstock with high-precision main spindle on a tapered roller bearing with 100 mm spindle bore for excellent stability under heavy loads
- very quiet operation at maximum spindle speed
- All guideways are generously sized and gears are hardened and ground
- Joystick control for X and Z feeds is mounted directly to support
- Manual 4-step auxiliary gearbox, premium frequency drive technology combined with main spindle motor ratings up to 7.5 kW allow exact tuning of speed and torque for heavy-duty machining
- Rapid feed for X and Z axis allow quick support positioning and less down-time
- Adjustable overload clutch in apron protects the feed mechanics from damages and failures

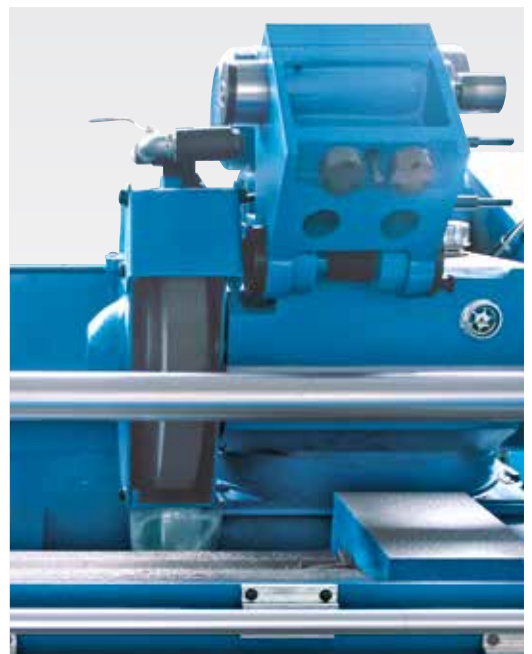

RSM Series Grinding Spindle

## Standard Equipment

2-axis position indicator, internal grinding equipment, open rest, closed rest, 3-jaw chuck Ø 200 mm, coolant system, grinding wheel dresser, balancing station, balancing mandrel, grinding wheel flange, center point, front and rear splatter guard, drivers, operating tools, operator manual, test certificate



Specifications RSM		750 C	1000 C	1500 C	2000 C
<b>Working area</b>					
Center height	mm	135	180	180	180
Grinding diameter	mm	8 - 200	8 - 320	8 - 320	15 - 320
With steady rest	mm	8 - 60	60	60	150
Grinding length	mm	750	1.000	1.500	2.000
Inside grinding diameter with rest	mm	35 - 100	35 - 100	35 - 100	35 - 100
Inside grinding diameter without rest	mm	25 - 100	30 - 100	30 - 100	30 - 100
Inside grinding depth	mm	125	125	125	125
Workpiece weight between centers (max.)	kg	80	150	150	150
Grinding wheel feed (min.)	mm	0,0025	0,0025	0,0025	0,0025
Chuck diameter	mm	200	200	200	200
Table swivel range (max.)		-2° / +6°	-3° / +7°	-3° / +6°	-3° / +5°
Wheel speeds	m/s	35	35	35	34,2
Work spindle speeds	1/min	50 Hz: 25-380	50 Hz: 25-220	50 Hz: 25-220	50 Hz: 25-220
<b>Travels</b>					
Grinding head travel	mm	200	250	250	250
<b>Feed</b>					
Table feed, infinitely variable	m/min	0,1 - 4	0,1 - 4	0,1 - 4	0,1 - 4
Feed per hand-wheel rotation X-axis	mm	0,5	1	1	1
Feed per scale division X-axis	mm	0,0025	0,0025	0,0025	0,0025
<b>Accuracies</b>					
Run-out deviation	mm	0,003	0,003	0,003	0,003
Cylindrical deviation	mm	0,008	0,01	0,01	0,01
Roughness	µm Ra	<=0,32	<=0,32	<=0,32	<=0,32
<b>Headstock</b>					
Working headstock swivel range	deg	0 - 45	0 - 45	0 - 45	0 - 45
Working spindle taper	MT	4	4	4	4
<b>Grinding headstock</b>					
Grinding spindle speed	1/min	0 - 1.670	0 - 1.670	0 - 1.670	0 - 1.305,6
Grinding headstock swivel range (r+l)		30°	30°	30°	30°
Inside grinding spindle speed	1/min	10.000	10.000	10.000	10.000
<b>Tailstock</b>					
Tailstock taper	MT	4	4	4	4
Tailstock quill stroke	mm	25	30	30	30
<b>Drive capacity</b>					
Motor rating - grinding spindle / hydraulic pump	kW	4 / 0,75	5,5 / 0,75	5,5 / 0,75	7,5 / 0,75
Motor rating inside grinding	kW	1,1	1,1	1,1	1,1
Motor rating - headstock / coolant pump	kW	0,75 / 0,13	1,5 / 0,125	1,5 / 0,125	1,5 / 0,125
<b>Measures and weights</b>					
Grinding wheels dimensions	mm	400x50x203	400x50x203	400x50x203	500x50x203
Grindstone dimensions, inside grinding (max.)	mm	50x40x16	50x25x13	50x25x13	50x25x13
Grindstone dimensions, inside grinding (min.)	mm	45x35x10	17x20x6	17x20x6	17x20x6
Overall dimensions (length x width x height)	m	3x1,8x1,65	3,61x1,81x1,52	4,61x1,81x1,52	5,61x1,81x1,52
Weight	kg	3.500	3.700	4.300	6.600
Part No.		302444	302445	302446	302447



See this machine  
in action on  
YouTube



RSM 800 is shown

### Extensive standard equipment

- Proven and extremely rigid machine frame made of premium cast-iron - this machine's high intrinsic weight, diligent design and production create optimum conditions for excellent grinding and sanding results
- Hydraulic linear feed features very precise, infinitely variable micro-feed



Grinding headstock can be rotated 180° to change from inside to outside grinding

- High-precision guideways of linear and transverse movement consisting of combined V-guides and box ways
- Hydraulic adjustment of the grinding headstock simplifies set-up, workpiece exchanges and reduces downtime
- Grinding spindle with segmented high-precision bearing, adjustable and low maintenance
- Work spindle speeds are infinitely variable and can be easily adjusted and optimized during the machining process
- machine table swivels for taper grinding
- Hydraulic tailstock with foot switch



RSM 500 A is shown

## Standard Equipment

2-axis position indicator, internal grinding equipment, 3-jaw chuck Ø 200 mm, chuck flange, balancing station, balancing mandrel, dress equipment, center point, grinding wheel flange, coolant system, open rest, closed rest, drivers, work lamp, operating tools, operator instructions

## Specifications

		RSM 500 A	RSM 800
<b>Working area</b>			
Center height	mm	135	135
Workpiece length (max.)	mm	650	950
Grinding length	mm	500	800
Grinding diameter	mm	8 - 200	8 - 200
Inside grinding diameter without rest	mm	10 - 100	13 - 100
Workpiece weight between centers (max.)	kg	50	50
Inside grinding depth	mm	125	125
Table swivel range (max.)	R / L	-3° / +9°	-3° / +8°
Wheel speeds	m/s	38	38
<b>Feed</b>			
Table feed, infinitely variable	m/min	0,1 - 4	0,1 - 4
Feed per scale division X-axis	mm	0,005	0,005
<b>Headstock</b>			
Work spindle speeds	1/min	25 - 220	25 - 380
Working headstock swivel range		0-45°	0-45°
Spindle taper	MT	4	4
<b>Grinding headstock</b>			
Inside grinding spindle speed	1/min	16.000	16.000
Grinding headstock swivel range (r+l)		± 30°	± 30°
<b>Drive capacity</b>			
Total power consumption	kVA	5,625	5,625
<b>Measures and weights</b>			
Grinding wheels dimensions	mm	400x50x203	400x50x203
Grindstone dimensions, inside grinding (max.)	mm	50x25x13	50x25x13
Grindstone dimensions, inside grinding (min.)	mm	17x20x6	17x20x6
Overall dimensions (length x width x height)	m	2,5x1,6x1,5	3x1,6x1,5
Weight	kg	2.500	3.000
Part No.		302430	370150



See this machine  
in action on  
YouTube 



- **SIEMENS touchscreen**
- **easy programming**
- **hydraulic table feed**
- **extensive standard equipment**

Fig. incl. optional accessories

- The massive, heavily ribbed cross-bed machine frame with traversing column and horizontal spindle is extremely rigid even under heaviest workpiece loads
- The large work area allows machining of single workpieces with large surface areas or machining of several workpieces in one setup
- The workspace is protected by an easily accessible enclosure
- A high-performance cooling system is included in the standard equipment of this series

### Control

- Grinding cycles for automatic face and groove grinding are accessible and editable via touchscreen
- Preloaded ball screws and powerful servo-motors on Y and X ensure high precision and repeatability during grinding wheel feeds

- An electronic hand-wheel for Y- and Z-axis simplifies setup and manual positioning of the grinding spindle
- If set to Auto mode, the user-defined roughing and finishing parameters, number of spark-out strokes, and return to zero are automatically processed

### Grinding spindle

- Large grinding spindle, dynamically balanced, completely sealed with permanent lubrication
- Preloaded precision-bearings ensure maximum grinding performance and high reliability over many production hours



The workspace is protected by an easily accessible enclosure

## Hydraulics

- Extremely quiet operation and minimal heat build-up for optimum work results under continuous operating conditions
- The hydraulic linear table feed is infinitely variable, maintains a constant speed with smooth travel direction reversals
- External hydraulic unit with oil cooler unit ensures perfect temperature stability

Specifications HFS F NC		50100	50160	60160	60200	80160	80220	80300
<b>Working area</b>								
Table dimensions	mm	500x1.000	500x1.600	600x1.600	600x2.200	800x1.600	800x2.200	800x3.000
Spindle center-table surface distance	mm	600	600	600	600	920	900	900
Table load capacity (max.)	kg	700	900	1.300	1.690	2.000	2.400	3.500
Magnetic chuck height	mm	110	110	110	110	110	110	110
<b>Travels</b>								
Travel X-axis	mm	1.000	1.600	1.600	2.200	1.600	2.200	3.000
Travel Y-axis	mm	500	500	630	630	810	810	810
<b>Feed</b>								
Hydr. feed X-axis	m/min	5 - 25	5 - 25	5 - 25	5 - 25	5 - 25	5 - 25	5 - 25
Feed Y-axis	mm/min	50 - 500	50 - 500	50 - 500	50 - 500	50 - 2.000	50 - 2.000	50 - 2.000
Feed depth, Y-axis	mm	0,005 - 0,05	0,005 - 0,05	0,005 - 0,05	0,005 - 0,05	0,005 - 0,05	0,005 - 0,05	0,005 - 0,05
Feed Z-axis	mm/min	50 - 600	50 - 600	50 - 600	50 - 600	50 - 2.000	50 - 2.000	50 - 2.000
Automatic Z-axis feed	mm/min	0 - 30	0 - 30	0 - 30	0 - 30	0 - 30	0 - 30	0 - 30
<b>Grinding wheel</b>								
Grinding wheels dimensions	mm	355x40 x127	355x40 x127	355x40 x127	355x40 x127	500x75 x305	500x75 x305	500x75 x305
Speed	1/min	1.450	1.450	1.450	1.450	960	960	960
<b>Drive capacity</b>								
Motor rating main drive	kW	7,5	7,5	7,5	7,5	18,5	18,5	18,5
Hydraulic motor rating	kW	3	3	5,5	5,5	7,5	7,5	7,5
Y-axis servo motor	kW	0,5	0,5	0,5	0,5	3	3	3
Z-axis servo motor	kW	2	2	2	2	3	3	3
<b>Measures and weights</b>								
Overall dimensions (length x width x height)	m	4,5x2,65 x2,7	6,01x2,5 x2,7	5,5x2,75 x2,7	6,5x2,75 x2,7	4,8x4 x2,6	6x4 x2,6	8,2x4 x2,6
Weight	kg	5.500	6.000	7.000	8.000	10.500	12.500	14.000
Part No.		124934	124935	124936	124937	124938	124939	124940

## Magnetic clamping plate

- Large magnetic chucks for torsion-free clamping across the entire work surface are included in the standard equipment
- The modern control also ensures reliable operation with firm holding forces and high-grade degaussing

## Standard Equipment

2-axis position indicator, electronic handwheel for Y- / Z-axis, grinding wheel flange, workspace enclosure, coolant system, diamond dresser stand (without diamond), balancing station, balancing shaft, work lamp, magnetic clamping plate, adjustment screws, operating tools, operator manual, Siemens PLC-control with Touchscreen, grinding wheel

Options	Part No.
• Coolant system with magnetic separator and paper filter	253467
• Parallel grinding wheel dresser for HFS F NC	253468
• Magnetic separator without reservoir for HFS F NC	253469



- designed for continuous operation at maximum speed, very quiet operation, maximum accuracy and minimal heat accumulation ensure optimum machining results
- Dual guides for linear table motion
- Spindle head and Z-axis move on precision linear guides with preloaded ball screws
- Servo drives on Y- and Z-axis and hydraulic linear table movement can be adjusted via an infinitely variable electronic proportional valve for precise and consistent feed
- 3-step electronic hand-wheel allows for precise positioning of the Y- and Z-axis



External hydraulic unit and oil cooler ensure thermal stability during continuous operation



## NC Control

- intuitive dialog-guided programming for automatic and semi-automatic sanding and dressing of grinding wheels, optimized for surface grinding
- Programming of grinding cycles per touchscreen
- easy adjustment of important parameters and feed rate during machining
- automatic fault and performance monitoring, display shows error message

## Standard Equipment

magnetic clamping plate, coolant system with magnetic separator, central lubrication, hydraulic oil cooler, grinding wheel flange, diamond dresser with holder, balancing station, setup feet, tool box, operator manual

## Options

- cooling water with magnetic and tape filtration for HFS NC

## Part No.

251573



Dressing mode for grinding wheels with automatic dimension and speed (rpm) compensation ensures constant grinding rate and can be entered while in auto mode

## Specifications HFS NC

52

73

104

160

### Working area

Grinding area (max.)	mm	520x200	720x300	1.020x400	1.700x400
Workpiece weights incl. magnetic clamping plate (max.)	kg	210	400	680	850
Spindle axis-to-table surface distance	mm	470	640	640	640
Dimensions magnetic clamping plate	mm	500x200	700x300	1.000x400	1.600x400
T-slots, width	mm	14	14	14	14
Number of T-slots	Pieces	1	1	3	3
Division (electronic hand-wheel) Y-axis	mm	0,001 / 0,005 / 0,01	0,001 / 0,005 / 0,01	0,001 / 0,005 / 0,01	0,001 / 0,005 / 0,01
Division (electronic hand-wheel) Z-axis	mm	0,01 / 0,05 / 0,1	0,01 / 0,05 / 0,1	0,01 / 0,05 / 0,1	0,01 / 0,05 / 0,1

### Travels

Travel X-axis	mm	560	800	1.120	1.780
Travel Z-axis	mm	230	330	430	430

### Headstock

Spindle speed	1/min	500 - 3.500	500 - 2.300	500 - 2.300	500 - 2.300
---------------	-------	-------------	-------------	-------------	-------------

### Rapid feed

Rapid feed Y-/Z-axis	mm/min	(10) 0 - 1.200	(10) 0 - 1.200	(10) 0 - 1.200	(10) 0 - 1.200
----------------------	--------	----------------	----------------	----------------	----------------

### Feed

Feed per rotation (electronic hand-wheel) - Y-axis	mm	0,1 / 0,5 / 1,0	0,1 / 0,5 / 1,0	0,1 / 0,5 / 1,0	0,1 / 0,5 / 1,0
Feed per rotation (electronic hand-wheel) - Z-axis	mm	1,0 / 5,0 / 10	1,0 / 5,0 / 10		1,0 / 5,0 / 10
Feed speed - X-axis (hydraulic)	m/min	min. 3 / max. 25	min. 3 / max. 25	min. 3 / max. 25	min. 3 / max. 25
Feed speed Z-axis	mm/min	0 - 1.200	0 - 1.200	0 - 1.200	0 - 1.200
Autom. feed - Micro-feed Y-axis	mm	0,0001 - 0,01	0,0001 - 0,01	0,0001 - 0,01	0,0001 - 0,01
Autom. feed - Coarse feed Y-axis	mm	0,005 - 0,04	0,005 - 0,04	0,005 - 0,04	0,005 - 0,04
Automatic Z-axis feed	mm	0,1 - 15	0,1 - 25	0,1 - 25	0,1 - 25

### Drive capacity

Motor rating main drive	kW	3,7	3,7	5,5	5,5
Motor rating hydraulic pump	kW	1,5	1,5	2,2	2,2
Motor rating coolant pump	kW	0,09	0,18	0,18	0,18
Z- and Y-axis servo motor	kW	0,55 / 0,55	0,55 / 0,55	0,55 / 0,55	0,55 / 1

### Measures and weights

Grinding wheel dimensions	mm	255x50,8x25	400x127x40	400x127x40	400x127x40
Overall dimensions (length x width x height)	m	2,4x1,75x2,4	2,9x1,9x2,5	3,8x2x2,5	6,5x3x2,5
Weight	kg	2.050	2.500	3.050	5.400
Part No.		122415	122420	122425	122430



- **SIEMENS touchscreen**
- **easy programming**
- **hydraulic table feed**
- **extensive standard equipment**

- The cast-iron machine frame features superior rigidity and torsional strength, precision guideways and excellent machining quality
- All guideways are lubricated reliably via a central lubrication system
- The workspace is protected by an easily accessible enclosure
- A powerful coolant pump is combined with a vacuum exhaust unit to clear grinding dust and aerosol during machining operations

### Grinding spindle

- Large grinding spindle, dynamically balanced, completely sealed with permanent lubrication
- Preloaded precision-bearings ensure maximum grinding performance and high reliability over many production hours

### Hydraulics

- Extremely quiet operation and minimal heat build-up for optimum work results under continuous operating conditions
- Hydraulically operated linear table movement, infinitely variable, high consistency, and soft reversal of direction
- External hydraulic unit with oil cooler unit ensures perfect temperature stability

### Magnetic clamping plate

- Large magnetic chuck allows for torsion-free clamping and is included in standard equipment
- The control unit is integrated into the electric system to simplify operation, allowing quick clamping and degaussing for maximum production efficiency



If set to Auto mode, the user-defined roughing and finishing parameters, number of spark-out strokes, and return to zero are automatically processed



## Programming

- The high-quality preloaded ball screw and a powerful servo-motor ensure high precision and repeatability of positioning on the Y-axis
- The machine features an electronic hand-wheel for configuration tasks and manual movement of the grinding spindle
- If set to Auto mode, the user-defined roughing and finishing parameters, number of spark-out strokes, and return to zero are automatically processed

## Standard Equipment

2-axis position indicator, electronic hand-wheel, grinding wheel flange, automatic central lubrication, workspace enclosure, coolant and suction device, grinding wheel dresser, balancing station, balancing shaft, LED work lamp, magnetic clamping plate, adjustment screws, operating tools, demagnetization unit, Siemens PLC-control with Touchscreen, operator manual

Specifications HFS Advance		2550 F	3063 F	4080 F	30100 F	40100 F
<b>Working area</b>						
Workpiece weight (max.)	kg	180	270	500	400	600
Spindle nose-to-table surface distance	mm	450	580	580	580	580
Table dimensions	mm	508x254	635x305	813x406	1.020x300	1.020x406
Dimensions magnetic clamping plate	mm	500x250	600x300	800x400	1.000x300	1.000x400
Scale ring division Y-axis	mm	0,005	0,005	0,005	0,005	0,005
Scale ring division Z-axis	mm	0,02	0,02	0,02	0,02	0,02
Autom. transverse feed Z-axis	mm	0,1 - 8	0,1 - 8	0,1 - 8	0,1 - 8	0,1 - 8
Speed	1/min	2.850	1.450	1.450	1.450	1.450
Autom. vertical feed	mm	0,005 - 0,05	0,005 - 0,05	0,005 - 0,05	0,005 - 0,05	0,005 - 0,05
<b>Travels</b>						
Travel X-axis	mm	560	765	910	1.130	1.130
Travel Y-axis	mm	275	340	450	340	450
<b>Feed</b>						
Hydr. feed X-axis	m/min	7 - 23	7 - 23	7 - 23	7 - 23	7 - 23
Rapid feed Y-axis	mm/min	480	480	480	480	480
Rapid feed Z-axis	mm/min	990	990	990	990	990
<b>Drive capacity</b>						
Motor rating main drive	kW	2,2	4	4	4	4
<b>Measures and weights</b>						
Grinding wheels dimensions	mm	200x20x31,75	350x40x127	350x40x127	350x40x127	350x40x127
Overall dimensions (length x width x height)	m	2,3x1,6x1,68	2,9x2,2x1,9	3,6x2,4x1,9	4,4x2,2x1,9	4,4x2,4x1,9
Weight	kg	1.800	2.800	3.400	3.200	3.700
Part No.		124931	124932	124933	124941	124930



- spindle resists high loads; mounted in pre-loaded angular deep-groove ball bearings ensures low-vibration operation, high accuracy, increased lifetime and low maintenance
- completely leak-proof and balanced spindle motor with high load capacity
- solid, vibration-absorbing construction
- V- and flat guides in X and Y directions for consistently high accuracy
- longitudinal table movement over linear ball guide; linear roller guideway
- adjustable hand wheel scales for vertical and transverse adjustments allows zeroing at any position
- central lubrication
- grinding parallelism 0,005 mm / 300 mm



Permanent magnetic clamping plates with micro pole pitch - ideal for high-precision grinding work

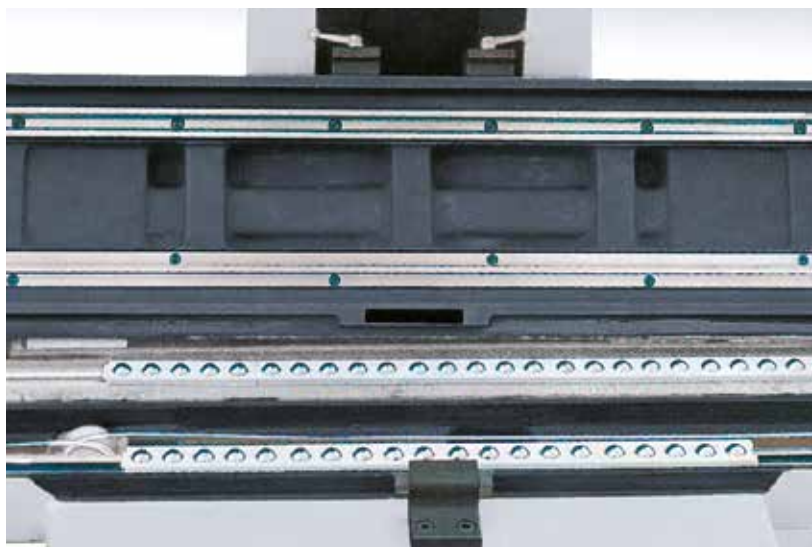

Linear ball guide for guide for smooth table travel



Angle-adjustable grinding vise (standard equipment)

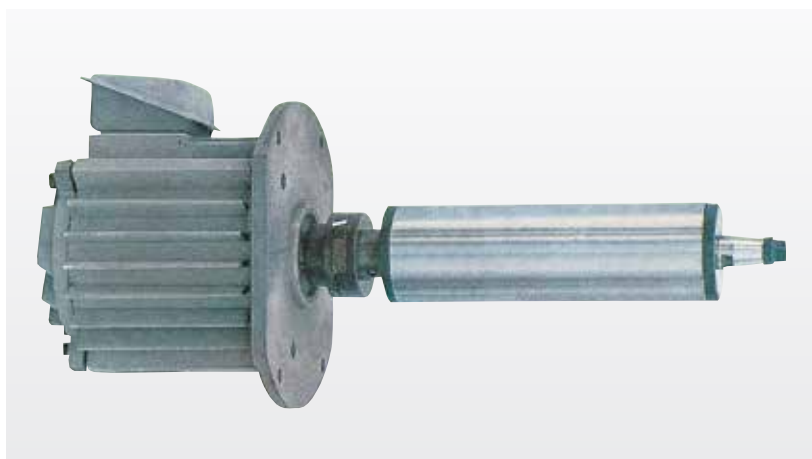

Main spindle drive with advanced precision bearing



PSG 50 is shown (optional)

## Specifications

### FSM 480

<b>Working area</b>		
Table dimensions	mm	210x450
Spindle axis-to-table surface distance	mm	450
<b>Travels</b>		
Travel X-axis	mm	480
Travel Y-axis	mm	230
Travel distance per hand-wheel rotation, X-axis	mm	5
Travel distance per hand-wheel rotation, Y-axis	mm	5
Travel distance per hand-wheel rotation, Z-axis	mm	1
<b>Feed</b>		
Scale ring division X-axis	mm	0,02
Scale ring division Y-axis	mm	0,02
Scale ring division Z-axis	mm	0,005
<b>Accuracies</b>		
Roughness	µm Ra	>= 0,63
<b>Drive capacity</b>		
Motor rating main drive	kW	1,5
<b>Measures and weights</b>		
Grinding wheel dimensions	mm	200x13x32
Weight	kg	730
Part No.		122802

## Standard Equipment

exhaust vacuum, work lamp, magnetic clamping plate 125 x 300 mm, diamond dresser, balancing shaft, balancing station, angle - adjustable grinding vise, grinding wheel dresser holder, operating tools, operator manual

## Options

### Part No.

• Coolant Concentrate 5 Ltr.	103184
• PSG 50	128826
• Parallel Gauge-Block Set, 83 pc.	129000
• Measuring Tool Set M5	108344
• Precision Angle V-Blocks	128930
• Magnetic V-Block I	108880
• Hydraulic measuring tripod	108810



See this machine  
in action on  
YouTube 



**Ideal for tool and die construction,  
mechanical production, design  
processes, laboratories and training.**

- **The functionality of the Multi-Grind ranges from external and internal cylindrical grinding to taper grinding. The Multi-Grind also allows easy tool grinding (sharpening of cutters, reamers and turning tools) and is suitable for light surface grinding job.**
- **Feed Drives**  
Hydraulic table feed (longitudinal) with automatic change of direction. An additional manually operated longitudinal feed with hydraulic support allows feed speeds up to 7 m/min.
- **Grinding Headstock** Special grinding headstock design allows simultaneous setup of 2 different grinding wheels. The grinding headstock can be moved in transverse direction and also vertically; and it can be rotated around the vertical axis.
- **Speeds**  
The headstock operates at 3 different speeds (110, 200, 300 min<sup>-1</sup>), which are set through an easy to operate gear shift lever.



Surface grinding with angle-adjustable vise

## Standard Equipment

coolant system, exhaust vacuum, tool mount / indexing head MT 4, internal grinding unit including 2 die grinders, 3-jaw chuck Ø 100 mm, left tailstock, right tailstock MT 2, center point, half center points, balancing station, spindle extension, vise for surface grinding (3-D angle adjustment), spring stop, 5 drivers, various splash guards, grinding wheel guard (2x), automatic central lubrication, operator manual, test certificate

## Options

	Part No.
• Live Center MT 2	106745
• milling tool Mount Diameter 16mm for MultiGrind 102781	421085

To see the available options for this machine, visit our website.

## Specifications

		Multi Grind
<b>Working area</b>		
Grinding diameter	mm	200
Workpiece length (max.)	mm	500
Outside grinding measure, maximum	mm	Ø 5-50 x 400
Inside grinding measures, optimal	mm	Ø 10-50 x 75
Tool grinding measure	mm	200x500
Workpiece length surface grinding	mm	200
Workpiece width surface grinding	mm	50
Workpiece weight (max.)	kg	10
Table swivel range (max.)		+45° / -30°
<b>Travels</b>		
Travel Z-axis	mm	480
<b>Feed</b>		
Feed per hand-wheel rotation X-axis, fine	mm	1
Feed per hand-wheel rotation X-axis, rough	mm	4
Feed per scale division X-axis, fine	mm	0,005
Feed per scale division, X-axis, rough	mm	0,02
Scale division of height adjustment	mm	0,01
Longitudinal feed speed (hydraulic)	m/min	0,01 - 6
Manual, hydraulic assist	m/min	7
<b>Headstock</b>		
Working headstock swivel range		± 90°
Working spindle speed	1/min	(3) 110 - 300
Working spindle taper	MT	2
Chuck diameter	mm	100
<b>Grinding headstock</b>		
Grinding spindle speed	1/min	2.500
Inside grinding spindle speed	1/min	13.500
Grinding headstock swivel range		± 90°
Grinding headstock - vertical / - transverse	mm	200
<b>Tailstock</b>		
Height adjustment per handwheel rotation	mm	1
Tailstock taper	MT	2
Tailstock quill stroke	mm	14
<b>Drive capacity</b>		
Machine drive capacity	kW	2,525
Motor rating main drive	kW	1,1
<b>Measures and weights</b>		
Grinding wheel dimensions	mm	200x20x75
Grindstone dimensions, inside grinding (min.)	mm	10x10x3
Grindstone dimensions, inside grinding (max.)	mm	25x20x6
Overall dimensions (length x width x height)	m	1,52x1,35x1,4
Weight	kg	1.300
Part No.		102781

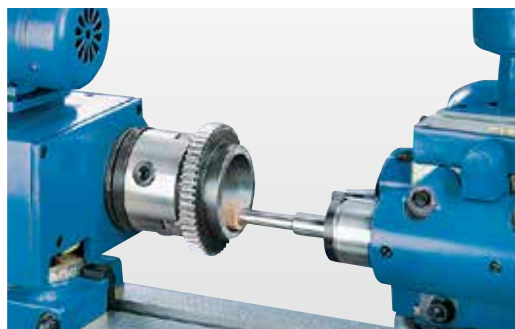

High-speed inside cylindrical grinding

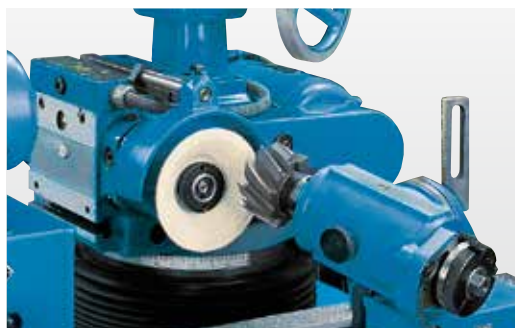

Rigid angle-adjustable workpiece mounts

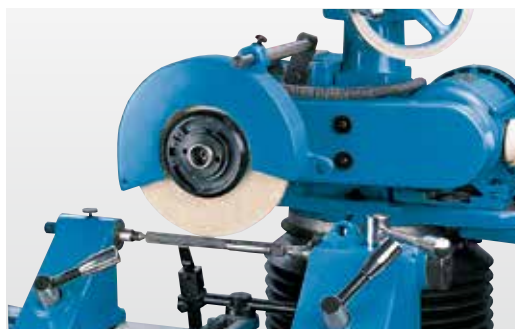

Swiveling headstock and extensive accessories

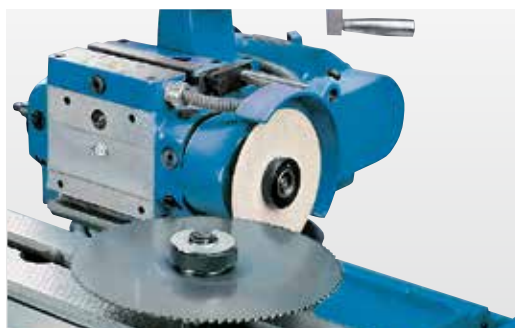

Saw blade sharpening

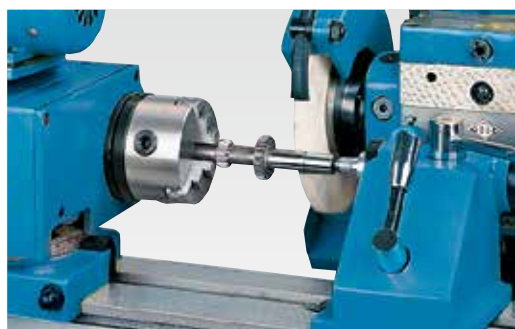

Outside cylindrical grinding for lengths up to 400 mm

Belt / Grinding Wheel Sander Combination

## KS 100 B

Small footprint - ideal for workshop operations

- incl. support table and workpiece stop for surface and edge grinding
- Sanding belt swivels to vertical position

### Standard Equipment

support table, stop, sanding belt, grinding wheel, operator instructions

### Specifications KS 100 B

Working area		
Table dimensions	mm	158x225
Belt speed	m/s	8
Angular adj. of table		45°
Drive capacity		
Motor rating main drive	kW	0,4
Supply voltage	V	230
Measures and weights		
Sanding pad diameter	mm	150
Blade dimensions	mm	100x915
Overall dimensions	m	0,56x0,27x0,3
Weight	kg	17
Part No.		102815



KS 100 B is shown

### Options

	Part No.
• Grinding Wheels K 180 / KS 100	102824
• Sanding Belt K 40 / KS 100	102735
• Sanding Belt K 180 / KS 100	102830
• Grinding Wheels K 40 / KS 100	102734

For additional options for this machine, visit our website.

Belt / Grinding Wheel Sander Combination

## KS 150 B

Compact combo grinding machine including machine base

- Large sanding surface for smoothing, beveling and deburring
- belt sander can be used horizontally and vertically
- Disk sander is ideally suited for contours, small surfaces and edges
- Support table swivels up to 45° and can be used for belt and disk sanding
- The included miter stop can be adjusted from 0° - 90°
- Powerful motors and low vibrations ensure optimum sanding results

### Standard Equipment

adjustable stop, support table, base, grinding wheel, sanding belt, operator instructions

### Specifications KS 150 B

Working area		
Angular adj. of table		45°
Belt speed	m/s	5,5
Belt sander with adjustable angle		90°
Sanding pad diameter	mm	230
Speed (disc)	m/s	23,3
Measures and weights		
Blade dimensions	mm	150x1.220
Height	mm	915
Weight	kg	50
Part No.		102816

KS 150 B is shown, Base is included



### Options

	Part No.
• Grinding Wheels K 40 / KS 150/BDS 9B	102721
• Grinding Wheels K 180 / KS 150/BDS 9B	102804
• Sanding Belt K 40 / KS 150/BTM 250/BKM/BDS 9B/BDS 12A	102725
• Sanding Belt K 180 / KS 150/BTM 250/BKM/BDS 9B/BDS 12A	102810

For additional options for this machine, visit our website.





Fig. B 150 D with integrated suction

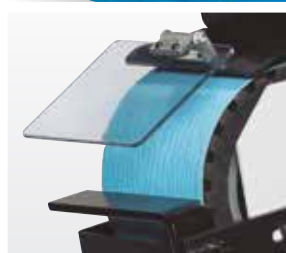

B 150 is shown

- Excellent grinding results due to minimal vibration during sanding belt operation and rigid design of all components
- The wide contact roll is ideal for grinding edges, points and radii
- Adjustable grinding support with adjustable eye protection for maximum accuracy and safety
- One cover encloses the longitudinal grinding surface while it is not in use
- Grinding belts can be changed within seconds via a quick-change vise, no tools required

- Chip collectors help keep the work environment clean
- The B150 D belt sander features a base with integrated vacuum exhaust

### Specifications

		B 150 D	B 150
<b>Working area</b>			
Contact wheel	mm	200x150	200x150
Belt dimensions	mm	150x2.000	150x2.000
Sanding area	mm	530x150	530x150
Belt speed	m/s	33	33
Speed	1/min	2.800	2.800
<b>Drive capacity</b>			
Motor rating main drive	kW	4	4
<b>Measures and weights</b>			
Driving roller (dimensions)	mm	225x150	225x150
Overall dim. (length x width x height)	m	1,05x0,62x1,27	1,05x0,62x1,27
Weight	kg	135	128
Part No.		102887	102886

### Standard Equipment B 150 D

base, 1 sanding belt, vacuum exhaust, safety observation shield, operator instructions

### Standard Equipment for B 150

machine base, 1 sanding belt, safety observation shield, support table, operator manual

### Options

Options	Part No.
• Sanding Belt K 40 / B 150 / BS 150 / BSM 150	112860
• Sanding Belt K 60 / B 150 / BS 150 / BSM 150	112861
• Sanding Belt K 80 / B 150 / BS 150 / BSM 150	112862

For additional options for this machine, visit our website.



Vertical grinding surface with support table

**Rigid steel base included**

## Standard Equipment

base, dust suction connector, stops, sanding belt, grinding wheel

- support table for disk and belt sanding
- easy belt change with quick-lock mechanism
- belt sander can be used horizontally and vertically
- dust suction connector at disk and belt sander unit
- balanced sander disk for vibration-free operation

## Options

	Part No.
• Grinding Wheels K 80 / BTM 250	112707
• Grinding Wheels K 240 / BTM 250	112711
• Sanding Belt K 80 / KS 150/BTM 250/BKM/BDS 9B/BDS 12A	102807
• Sanding Belt K 240 / KS 150/BTM 250/BKM/BDS 9B/BDS 12A	102811

For additional options for this machine, visit our website.

## Specifications

		BTM 250
<b>Working area</b>		
Belt speed	m/s	8,4
Speed	1/min	1.600
Table area, belt-grinding	mm	152x267
Table area, disc-grinding	mm	190x330
Angular adj. of table		45°
<b>Drive capacity</b>		
Motor rating main drive	kW	1,1
<b>Measures and weights</b>		
Sanding pad diameter	mm	250
Blade dimensions	mm	150x1.220
Overall dimensions (length x width x height)	m	0,59x0,66x1,55
Weight	kg	78
Part No.		112700

### Specifications

### SM

Grinding diameter	mm	25
Speed	1/min	5.200
Collet chuck diameter	mm	18
Taper grinding		0° ~ 180°
Rear angle	deg	0 ~ 45
Hand-wheel rotation, spindle	mm	8
Hand-wheel rotation, tool holder	mm	18
Travel tool holder	mm	140
Motor rating main drive	kW	0,18
Grinding wheels dimensions	mm	100x50x20
Overall dimensions (length x width x height)	m	0,45x0,4x0,35
Machine weight	kg	56
Base weight	kg	17
Part No.		102880



Shown with standard equipment

### Standard Equipment

base, wheel mount, grinding wheel, spare parts list, collets 3, 4, 6, 8, 10 mm, operating tools, operator manual, test certificate

### Options

### Part No.

• Diamond Wheel / SM	102861
• Collet 2.5mm / SM	102864
• Grinding Wheel Flange / SM	102874

For additional options for this machine, visit our website (Product Search)

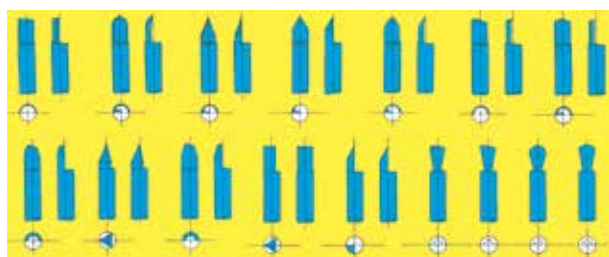

- max. bevel width 3 mm
- excellent surface quality
- quicker and more uniform results
- very long service life due to reversible tool tips (usable on 4 sides)

### Options

### Part No.

• Replacement Tool Bits / KF 500	101354
----------------------------------	--------

### Specifications

### KF 500

Angle adjustment		15 - 45°
Speed (max.)	1/min	3.400
Motor rating main drive	kW	0,75
Supply voltage	V	230
Table length	mm	500
Weight	kg	29
Part No.		101355

Dual pedestal grinder

## DSB D

Rigid Dual Pedestal Grinders for industrial and commercial operations

- heavy-duty design with rigid cast-iron body and maintenance-free motor
- balanced rotor and premium bearings ensure quiet operation and optimum results
- safety always comes first: emergency stop switch and safety observation shield
- premium components for long tool life and endurance under rough workshop conditions



DSB 300 D is shown



Rigid, wide material support ensures operator safety

### Standard Equipment

base, safety observation shield, 2 universal corundum wheels

Options	Part No.
• Roughing Disk	112145
• Finishing Disk	112146

Specifications DSB		200 D	250 D	300 D
Speed	1/min	2.950	2.950	1.450
Motor rating main drive	kW	0,9	0,9	2,2
Grinding wheels dimensions	mm	200x32x30	250x32x30	300x50x75
Weight	kg	28	32	84
Part No.		112151	112152	112150

Tool-Post Grinder

## SUS 210 • SUS 190

For external cylindrical

Specifications		SUS 190	SUS 210
Speed	1/min	3.850	3.320
Motor rating main drive	kW	0,375	0,75
Grinding wheel dimensions	mm	175x20x32	200x20x32
Overall dimensions (length x width x height)	m	0,46x0,32x0,39	0,57x0,33x0,39
Weight	kg	26	33
Part No.		112795	112796

- Grinding attachment can be clamped to the tool holder bolt (SUS 210 Ø 40 mm, and SUS 190 Ø 35 mm)

Options	Part No.
• Standard Cordundum Grinding Wheels / SUS 210	112797
• Silicon Carbide Grinding Wheels / SUS 210	112798



SUS 210 is shown



Drill bit grinding machine

## KSM 13

For HSS and carbide drills with diameters from 4 to 13 mm



- Chamfering of relief angle (rear of drill bit), chamfering of point angle
- Point grinding (KSM 13 S)

Specifications		KSM 13	KSM 13 S
Grinding diameter	mm	4 - 13	4 - 13
Grinding wheel material		CBN	CBN
Motor rating main drive	kW	0,18	0,18
Overall dims. (length x width x height)	m	0,4x0,22x0,29	0,4x0,22x0,29
Weight	kg	22	22
Supply voltage	V	220	220
Part No.		112820	112825

Options	Part No.
• Grinding wheel for KSM 13	112821
• Grinding wheel for KSM 13 S	112829

End mill grinder

## FSM 14 S



Specifications		FSM 14 S
Grinding diameter	mm	4 - 14
Grinding wheel material		CBN
Motor rating main drive	kW	0,16
Overall dimensions (length x width x height)	m	0,61x0,25x0,3
Weight	kg	22
Part No.		112805

Options	Part No.
• Face cutter grinding wheel for FSM 14 S	112801
• Diagonal cutter grinding wheel for FSM 14 S	112802

Tap Grinder

## GSM 20



Specifications		GSM 20
Grinding area		M5 - M20
Point angle	deg	5 - 30
Speed	1/min	5.300
Motor rating main drive	kW	0,18
Overall dimensions (length x width x height)	m	0,35x0,23x0,27
Weight	kg	12
Part No.		112810

Options	Part No.
• Diamond cutting wheel for GSM 20	112811

# Cutting systems

**See for yourself live:** Many models are in stock or can be viewed and tried out at a user's location near you. Make a demonstration appointment! [info@knuth.com](mailto:info@knuth.com)



## Experience our machines in action!

With our YouTube channel KNUTH Machine Tools, you stay up to date with all the news and developments.



Laser cutting system

## ACE Laser MAX

Table length **3.000 - 6.000 mm**  
CW beam power **1.000 - 4.000 W**

The latest cutting technology with shuttle table system

from page 214 onwards



Laser cutting system

## ACE Laser Compact

Table size **1300 x 1300 mm mm**

Fiber laser **1000 - 2000 W**

ACE Laser Compact R models are equipped with powerful Raycus laser sources

from page 220 / 221 onwards



Plasma cutting system

## Plasma-Jet

Table length **3.000 - 6.000 mm**

Cutting current **105 - 400 A**

Top class plasma cutting systems with Kjellberg or Hypertherm technology

from page 224 onwards



Waterjet cutting system

## Water-Jet

Table length **2.000 - 8.000 mm**

Motor power of high pressure pump **37 kW**  
(More by request)

For solving cutting tasks in almost any material, even with 5-axis technology

from page 232 onwards



# Precision Cuts for Mega yachts

Laurenat Isoliertechnik cuts polished stainless steel using the ACE Laser 3015 1.5 by KNUTH.



## What convinced them to turn to KNUTH?

- Test cuts: Live demo with 1:1 customer orders
- Consultation: cost-effective solution featuring high precision and long service life
- Service: quick support and response to user inquiries
- Customer-oriented: When machine deliveries were delayed due to the pandemic, KNUTH handled their customers' cutting jobs in-house

In 2001, the brothers, André and Ralf Laurenat, started their business in Schönkirchen, Germany, offering a wide variety of insulation technology services. Today, the business has seven employees and is one of the leading insulation specialists for ship exhaust systems. "Since we specialize on the repair and customization of mega yachts, we mainly process polished stainless steel in thicknesses of 0.6 mm to 1.5 mm," explained André Laurenat. The resulting exhaust gases reach temperatures up to 600 degrees Celsius. Laurenat uses special insulation materials in order to keep the pipe surface temperature at just 60 degrees C. The high temperatures present a real challenge in regards to materials and processing. Therefore, maximum accuracy and precision are of utmost importance when cutting stainless steel. With these strict requirements and difficult materials, the existing machine had reached its limits. André Laurenat started researching laser cutting systems and turned to KNUTH Machine Tools for advice. "Within a few days after their inquiry, one of our Application Engineers and I drove to Schönkirchen to look at their current process," said Christoph Ziebarth, Sales Manager for KNUTH Northern Germany.

## A high-precision and cost-effective solution

Ziebarth invited the brothers Laurenat to visit the KNUTH Cutting Center, where they could watch a demo of suitable machines and also try them out by cutting sample workpieces. "For the sample cuts, André Laurenat had sent us a 1:1 drawing of a customer order and he brought the respective stainless steel plate with him. This way, they could see and experience a direct comparison to their previous work and quality," said Ziebarth. He recommended the ACE Laser 3015 1.5. This machine could easily fulfill the strict requirements in regards to precision, while still being a cost-effective solution. "We don't use the cutter every day, but now we save a lot of time by handling any laser cutting in-house, and we have





To find the perfect solution for complex cutting tasks, the current state must be analyzed first, then the required state can be defined.



ACE LASER are known for their extremely low operating cost and very user-friendly design.



An automatic changer table system minimizes down-times.

much more flexibility in regards to the cut parts. Mega yachts always need unique custom parts, and any repairs must be completed quickly,” explained Laurenat. The ACE Laser 3015 1.5 with its bilateral drives and a work area of 3000 × 1500 mm can handle all common plate formats and is available with 1 kW to 6 kW Laser power. The automatic laser cutter head features auto focus (motorized focus positioning), automatic level control and collision guard to ensure a consistently high cutting quality.

### Perfect teamwork: Sales, Technology and Customer

When the Corona pandemic delayed the promised May 2020 delivery date to August, Laurenat and KNUTH found a practical and flexible solution. “We were able to have our most urgent orders cut directly at KNUTH’s Wasbek facilities. That was perfect teamwork between KNUTH Sales and Technology and us, the customer,” said André Laurenat. At Schönkirchen, the company had their workshop enlarged and the necessary high voltage connections installed for the new system. Ziebarth recounts: “After our on-site visit with the

electrician and the KNUTH Set-Up Team, the actual set-up of the machine went smoothly as expected.” Immediately after the set-up, the operator training started. After a two-day introductory training, the operators could become more familiar and experienced with the machine, before another two-day training session was conducted to answer more in-depth questions. André Laurenat expressed his satisfaction in his pragmatic way: “The machine does what it is supposed to do, and if we are unsure about anything, we just call KNUTH and we will get a quick and clear answer.

Laurenat Isoliertechnik GbR  
 Bürgermeister-Schade-Str. 2-4  
 24232 Schönkirchen, Germany  
 Tel. +49 (0) 4348 9192 24  
[www.laurenat-isoliertechnik.de](http://www.laurenat-isoliertechnik.de)



ACE Laser 3015 MAX is shown

- This state-of-the-art laser cutting system features a gantry-style construction with drives on both sides and a large working area of 3000 x 1500mm or 4000 mm x 2000 mm that can accommodate most of the common plate sizes
- The Y axis portal features an aluminum die-cast construction with low weight and high rigidity for excellent dynamics
- Thermal treatment of the meticulously welded machine frame and all structural parts reliably eliminates production-related material stresses – ensuring long-lasting, precise alignment of all components. This ensures long-term and reproducible cutting edge accuracy and long machine life
- The precision linear guides require minimal maintenance and are designed for long-lasting precision and high cutting speeds.
- High-precision rack-and-pinion gears on the Z and Y axis ensure superior and reliable positioning accuracy
- Powerful servo-motors on all axes ensure high reliability and dynamics of the cutter system
- For the safety of people and the environment, the cutting system is equipped with a machine housing and filter extraction system. Special protective glass windows make it possible to observe the cutting process
- An automatic shuttle table system minimizes production downtimes, since the table can be loaded and unloaded during the cutting process
- Perpendicularity or squareness tolerance for laser cutting acc. to DIN EN ISO 9013-1

For more machines of this series, visit our website



See this machine in action on YouTube



Option: For tube diameters up to 100 mm and tube lengths up to 3 m

## Control

- Easy operation with user-friendly optimized interface
- Technology database includes cutting parameters and pre-set cycles for various metals
- The efficient processing of all cutting jobs is further supported by user-friendly software for the selection of process parameters
- Solenoid and proportional valves regulate the gas pressures (set in the control) during the cutting process

## Cutter head

- High-quality cutter head made by Raytools with motorized focus position adjustment, integrated collision guard, and level control
- Maintenance-free beam guide is provided by a flexible fiberoptic cable and ensures a long tool life

## Laser sources

- The ytterbium fiber laser provides 1000 to 6000 W beam power, is made by the renowned manufacturer, Maxphotonics, and ensures maximum cut quality and productivity
- The maintenance-free laser source reduces maintenance and operating cost
- **Laser cutting systems with more laser power upon request**



ACE Laser 3015 is shown

Specifications ACE Laser MAX		3015 1.0	3015 1.5	3015 2.0	3015 3.0	3015 4.0	3015 6.0
<b>Working area</b>							
Table dimensions	mm	3.000x1.500	3.000x1.500	3.000x1.500	3.000x1.500	3.000x1.500	3.000x1.500
Workpiece weight (max.)	kg	1.000	1.000	1.000	1.000	1.000	1.000
Axis acceleration X / Y axis	m/s <sup>2</sup>	10	10	10	10	10	10
Axis acceleration Z axis	m/s <sup>2</sup>	5	5	5	5	5	5
<b>Travels</b>							
Travel X-axis	mm	1.520	1.520	1.520	1.520	1.520	1.520
Travel Y-axis	mm	3.050	3.050	3.050	3.050	3.050	3.050
Travel Z-axis	mm	100	100	100	100	100	100
<b>Rapid feed</b>							
X-axis rapid feed	m/min	100	100	100	100	100	100
Y-axis rapid feed	m/min	100	100	100	100	100	100
Change time at cutting table	sec	10 - 15	10 - 15	10 - 15	10 - 15	10 - 15	10 - 15
<b>Accuracies</b>							
Positioning accuracy	mm/m	0,03	0,03	0,03	0,03	0,03	0,03
Repeatability	mm/m	0,02	0,02	0,02	0,02	0,02	0,02
<b>Laser</b>							
Fiber laser	W	1.000	1.500	2.000	3.000	4.000	6.000
Shaft length	µm	1,08 ± 10%	1,08 ± 10%	1,08 ± 10%	1,08 ± 10%	1,08 ± 10%	1,08 ± 10%
Beam power max.	W	1.000	1.500	2.000	3.000	4.000	6.000
Power consumption	kW	3,5	5,3	6,5	12	16	20
Supply voltage	AC 380V ± 10%, 50/60Hz, 3xL+N						
Cutting capacity in structural steel	mm	8	12	14	18	20	20
Cutting capacity in stainless steel	mm	3	4	5	6	8	12
Cutting capacity in aluminum	mm	2	3	4	5	8	12
<b>Drive capacity</b>							
Machine drive capacity X-axis	kW	1	1	1	1	1	1
Machine drive capacity Y-axis	kW	1,5	1,5	1,5	1,5	1,5	1,5
Machine drive capacity Z-axis	kW	0,4	0,4	0,4	0,4	0,4	0,4
<b>Measures and weights</b>							
Overall dims. (length x width x height)	m	9,8x3,7x2,15	9,8x3,7x2,15	9,8x3,7x2,15	9,8x3,7x2,15	9,8x3,7x2,15	9,8x3,7x2,15
Weight	kg	8.000	8.000	8.000	8.000	8.000	8.000
Part No.		141040	141041	141042	141043	141044	141056



## Standard Equipment

Complete system with CNC-control (CypCut), Ytterbium Faserlaser MAXPHOTONICS, fibre optics, RayTools HP Cutter Head, automatic focus position adjustment, laser protection booth, automatic changing table system, filter exhaust system, automatic gas console, central lubrication, coolant return cooler, CAD/CAM software (CypCut), operating manual and programming instructions

Options	Part No.
• pipe cutting device 3m ( 1-4 kW)	253238
• Structural Steel Ace Laser Starter Set	253342
• Stainless Steel/Aluminum Ace Laser Starter Set	253343
• COMPAC - 2200 Air Dryer	253629

Specifications ACE Laser MAX		4020 1.0	4020 1.5	4020 2.0	4020 3.0	4020 4.0	4020 6.0
<b>Working area</b>							
Table dimensions	mm	4.000x2.000	4.000x2.000	4.000x2.000	4.000x2.000	4.000x2.000	4.000x2.000
Workpiece weight (max.)	kg	1.500	1.500	1.500	1.500	1.500	1.500
Axis acceleration X / Y axis	m/s <sup>2</sup>	10	10	10	10	10	10
Axis acceleration Z axis	m/s <sup>2</sup>	5	5	5	5	5	5
<b>Travels</b>							
Travel X-axis	mm	2.020	2.020	2.020	2.020	2.020	2.020
Travel Y-axis	mm	4.050	4.050	4.050	4.050	4.050	4.050
Travel Z-axis	mm	100	100	100	100	100	100
<b>Rapid feed</b>							
X-axis rapid feed	m/min	100	100	100	100	100	100
Y-axis rapid feed	m/min	100	100	100	100	100	100
Change time at cutting table	sec	12 - 17	12 - 17	12 - 17	12 - 17	12 - 17	12 - 17
<b>Accuracies</b>							
Positioning accuracy	mm/m	0,03	0,03	0,03	0,03	0,03	0,03
Repeatability	mm/m	0,02	0,02	0,02	0,02	0,02	0,02
<b>Laser</b>							
Fiber laser	W	1.000	1.500	2.000	3.000	4.000	6.000
Shaft length	µm	1,08 ± 10%	1,08 ± 10%	1,08 ± 10%	1,08 ± 10%	1,08 ± 10%	1,08 ± 10%
Beam power max.	W	1.000	1.500	2.000	3.000	4.000	6.000
Power consumption	kW	3,5	5,3	6,5	12	16	20
Supply voltage		AC 380V ± 10%, 50/60Hz, 3xL+N					
Cutting capacity in structural steel	mm	8	12	14	18	20	20
Cutting capacity in stainless steel	mm	3	4	5	6	8	12
Cutting capacity in aluminum	mm	2	3	4	5	8	12
<b>Drive capacity</b>							
Machine drive capacity X-axis	kW	1	1	1	1	1	1
Machine drive capacity Y-axis	kW	1,5	1,5	1,5	1,5	1,5	1,5
Machine drive capacity Z-axis	kW	0,4	0,4	0,4	0,4	0,4	0,4
<b>Measures and weights</b>							
Overall dims. (length x width x height)	m	10,34x4,28x2,2	10,34x4,28x2,2	10,34x4,28x2,2	10,34x4,28x2,2	10,34x4,28x2,2	10,34x4,28x2,2
Weight	kg	9.000	9.000	9.000	9.000	9.000	9.000
Part No.		141045	141046	141047	141048	141049	141057

## ACE Laser Compact R

All the advantages of advanced fiber laser technology in a small package



- Rapid feed speed up to 40 m/min
- Laser power up to 2000 W
- Large work area
- Nesting software included

- The machine frame is made of a rigid steel weldment, ensuring production-related stress on the material is eliminated
- The gantry is an aluminum die-cast construction with low weight, high rigidity, and servo-drives on both sides for excellent dynamics
- The linear guides on all axes require minimal maintenance and are designed for long-lasting precision and high cutting speeds

- High-quality preloaded ball drives on all axes ensure above-average positioning accuracy
- A central lubrication system supplies lubricant to all guide components, simplifying maintenance and extending machine life
- The cutting system is fully enclosed to protect operators and the environment
- A safety glass window in the door allows direct monitoring of the cutting process

## Control

- The powerful PC-based control is easy to operate via an application-specific user interface
- A technology database includes cutting parameters and pre-set cycles for various metals
- The efficient processing of all cutting jobs is further supported by user-friendly software for the selection of process parameters
- Solenoid and proportional valves regulate the gas pressures (set in the control) during the cutting process

## Nesting Software

- The Cypcut software provides all functions needed for the machining of cutting contours, and displays the current operating status
- Automatic nesting saves much time, allows custom adjustments and ensures minimal material waste
- The software includes predefined nesting patterns that cover a wide variety of practical applications

## Cutting head

- The proven RayTools cutting head features an integrated collision guard, automatic focus positioning, and height control
- Focus lenses can automatically change the position in the range of 25 mm (+10 ~ -10 mm) with an adjustment accuracy of 0.05 mm
- The laser beam focus continuously adjusts itself based on material conditions during program execution
- The drawer-type lens holder allows for quick and easy replacement of protective lenses

## Laser Sources

- ACE Laser Compact R models are equipped with powerful Raycus laser sources
- Raycus laser sources are known for their high reliability, electro-optical conversion efficiency at high energy density and wide modulation frequency
- Low-maintenance beam guide is provided by a flexible fiberoptic cable and ensures long tool life

## Standard Equipment

Complete system with CNC-control (CypCut), Ytterbium fiber laser by Raycus, fibre optics, high-pressure cutting head by Raytools, automatic focus position adjustment, laser protection booth, automatic gas console, central lubrication, coolant return cooler, CAD/CAM software (CypCut), operating manual and programming instructions

## Options

## Part No.

- | Options                              | Part No. |
|--------------------------------------|----------|
| • Vacuum and filter system by Kemper | 253848   |

Specifications ACE Laser Compact		1313 1.0 R	1313 1.5 R	1313 2.0 R
<b>Working area</b>				
Table size	mm	1.300x1.300	1.300x1.300	1.300x1.300
Maximum workpiece weight	kg	250	250	250
Axis acceleration X- / Y-axis	m/s <sup>2</sup>	5	5	5
<b>Travels</b>				
Travel X-axis	mm	1.320	1.320	1.320
Travel Y-axis	mm	1.320	1.320	1.320
Travel Z-axis	mm	80	80	80
<b>Rapid feed</b>				
X-axis rapid feed	m/min	40	40	40
Y-axis rapid feed	m/min	40	40	40
<b>Accuracies</b>				
Positioning accuracy X- / Y-axis	mm	± 0,03	± 0,03	± 0,03
Repeatability X- / Y-axis	mm	± 0,02	± 0,02	± 0,02
<b>Laser</b>				
Fiber laser	W	1.000	1.500	2.000
Laser source		Raycus	Raycus	Raycus
Shaft length	µm	1,08 ± 10%	1,08 ± 10%	1,08 ± 10%
Power consumption	kW	3,6	6	7
Cutting capacity in structural steel	mm	8	10	12
Cutting capacity in stainless steel	mm	4	5	6
Cutting capacity in aluminum	mm	2	4	5
<b>Measures and weights</b>				
Overall dimensions (length x width x height)	m	2,52x2,17x1,88	2,52x2,17x1,88	2,52x2,17x1,88
Weight	kg	2.040	2.040	2.040
Part No.		141100	141101	141102



See this machine  
in action on  
YouTube 



### Wide variety of equipment packages featuring up to 5-axis cutters

- stand-alone cutter table features rigid steel construction for high load capacity
- stand-alone table eliminates thermal and mechanical influences on the plasma cutter system
- the structure of the machine and the selection of components are designed to enable multi-shift operation
- dual-drive bridge
- high-quality linear guides on all axes
- dynamic AC servo drives on all axes with maintenance-free, zero-backlash planetary gears
- low-wear and low-maintenance helical gears are designed for continuous operation
- automatic torch height control
- quick-coupling for cutter head allows quick head exchanges for reduced tooling time
- available with 5-axis cutter head, tube cutter, and many more options
- optimum bed speed even for fine contours and tight radii
- use the existing cutting parameters stored in the control to find the optimum cut





Shown with additional „Messer“ oxy-fuel cutter head (optional)



Eckelmann CNC unit with 19" touchscreen for TrueCut K models



### Standard Equipment Hypertherm®

Table prepared for filter system (automatic closure control), Panasonic Servomotors and drivers, Automatic burner height control with Hypertherm THC sensor, Cutting torch with magnetic coupling and crash sensor, Hypertherm Edge Connect CNC-Unit, 19" Touchscreen from ELO, Ethercat-E, Laserpointer, ProNest Nesting Software

Specifications TrueCut		1530 K	1530 H	2040 K	2040 H	3060 K	3060 H
<b>Working area</b>							
Cutting Width	mm	1.500	1.500	2.000	2.000	3.000	3.000
Cutting length	mm	3.000	3.000	4.000	4.000	6.000	6.000
Table height	mm	700	700	700	700	700	700
Table load capacity	kg/m <sup>2</sup>	520	520	520	520	520	520
Rapid feed	mm/min	18.000	18.000	18.000	18.000	18.000	18.000
Weight (without plasma source)	kg	3.100	3.100	4.100	4.100	9.500	9.500
Plasma source		Kjellberg	Hypertherm	Kjellberg	Hypertherm	Kjellberg	Hypertherm
Part No.		144038	144014	144039	144015	144040	144016

### Options

### Part No.

• Maxpro 200 Plasma source	253406
• XPR 170 Core Plasma source	253407
• XPR 170 VWI Plasma source	253408
• XPR 170 Optimix Plasma source	253409
• XPR 300 Core Plasma source	253410
• XPR 300 VWI Plasma source	253411
• XPR 300 Optimix Plasma source	253412
• Smart Focus 130 Plasma source	253088
• Smart Focus 170 Plasma source	253652
• Smart Focus 200 Plasma source	253089
• Smart Focus 300 Plasma source	253090
• Smart Focus 400 Plasma source	253091
• Q 1500 Allgas Plasma source	253864
• Q 3000 Allgas Plasma source	253865

### Standard Equipment Kjellberg®

Table prepared for filter system (automatic closure control), Panasonic Servomotors and drivers, Automatic burner height control from Eckelmann, Cutting torch with magnetic coupling and crash sensor, Eckelmann CNC-Unit, 19" Touchscreen from ELO, A-Modul from Beckhoff, Laserpointer, Eckelmann IBE Software cncCUT Nest, Eckelmann IBE Software cncCUT Epost

# Plasma-Jet Increases Process-Efficiency

Wahlers Forsttechnik is one of Germany's leading suppliers of forestry machinery. After their purchase of a KNUTH Plasma-Jet Compact, this supplier can now cut all their steel parts in-house.



## What convinced them to turn to KNUTH?

- Specialist consultation: specialist consultants provide advice at the customer's site
- Dialog-guided user interface: cutting software and drawing program provide an intuitive user-friendly interface
- Operator training: intensive 2-day introduction to plasma-cutting
- Excellent cutting results: effective, cost-efficient cutting processes without any need for rework

Wahlers is a general importer for Ponsse, the worldwide leading forest machinery manufacturer, and delivers yearly 80 machines for harvesting and transporting trees to their customers in Germany, Austria, Switzerland and the Netherlands. "We retrofit every other forest machine with additional equipment, like cable winches, clambunks, grapples or stanchions," explained Fabian Haarhaus, Master Mechanic at Wahlers. Since February 2020, the company uses a KNUTH Plasma-Jet Compact H 1530 with Hypertherm cutting technology for steel sheet cutting needs. This saves them outsourcing cost and, most importantly, time.

## Specialist Consultation

"In the past, we outsourced about 60% of our cutting tasks. The remaining 40% were cut and deburred manually, which was a labor-intensive process. With our outdated guillotine shears, it took one to two hours to finish one workpiece," said Haarhaus. In 2019 he started looking for a plasma cutter that could provide clean cuts in up to 32 mm thick structural steel

and would provide an intuitive user interface for easy operation. KNUTH associate, Andreas Hendrich, had the perfect offer. He brought their Cutting Specialist, Faruk Saglam, along to the customer's site to provide in-depth consultation. "The Plasma-Jet fully meets our expectations, and the Hypertherm cutting technology ensures great cutting results," explained Haarhaus. The machine features a MaxPro 200 plasma source and a table for cutting widths up to 1.500 mm and cutting lengths up to 3.000 mm. Since the cutting process generates fumes and dust, the machine has been prepared for the connection of a filtered exhaust system with automatic shutter control. Wahlers opted for a high-efficiency dust collector and filtration unit with 4.000 m<sup>3</sup>/h



One finished part welded from a variety of cut parts that were produced with a KNUTH Plasma-Jet



A leap forward in respect to quality: The left component has been cut with a manual plasma cutter prior to this purchase. The center part with precision cut edges was cut with the KNUTH Plasma-Jet.

capacity. The cutting system was also equipped with a refrigeration dryer to adapt it to the existing compressed air system.

## Intelligent Software Solution, Faster Production

Six shop employees attended a 2-day training course led by Faruk Saglam to become familiar with the special requirements of plasma cutting and efficient operation of the Plasma-Jet cutter. The Libellula Wizard PRO software allows the user to choose from a selection of standard shapes and merely adjust the measurements. The software also suggests parameter settings that will provide the best cutting results based on the respective material. Two employees were trained in the Libellula.CAD 2D drawing program that allows them to create and store their own shapes. "The Plasma-Jet definitely speeds up our processes and we can complete all cutting tasks in-house," said Haarhus. The system is in use one or two hours every morning to cut parts for frames, cable winches, reinforcement plates for cranes and aggregates,



The component is tested and then manufacturing details are discussed

which then will be welded together in the afternoon. "Now, we can work with much more flexibility than before," stated Wahlers' Shop Manager. "And there is no need for rework as before with the manual cuts, since the cut edges are of good quality." In order to ensure long-term uninterrupted productivity, Wahlers also entered a Maintenance Agreement with KNUTH, and they added a multi-user license to cover programming of the entire in-house network.

Wahlers Forsttechnik GmbH & Co. KG  
Max-Schmeling-Straße 6, 27389 Stemmen  
Tel. +49 (0) 4267 93020

[www.wahlersforsttechnik.de](http://www.wahlersforsttechnik.de)

## Plasma-Jet Compact

The compact cutting machine of Kjellberg and Hypertherm



- The Plasma-Jet Compact Series set themselves apart from the Plasma-Jet TrueCut series by a fully integrated machine frame that is connected to the table via a bottom plate, so the machine can be transported in one piece and requires minimum space
- If small plasma sources (e.g. Powermax) are used, they also are stored on a shelf inside the frame
- The standard equipment includes the same high-quality components as the larger series: dual-drive bridge, high-quality linear guides, dynamic AC servo-drives, helical gears, automatic torch height control, magnetic cutter head holder serving as collision guard, optimum cutting data preset in the control.
- These machines provide the same excellent cutting performance as the Plasma-Jet TrueCut series

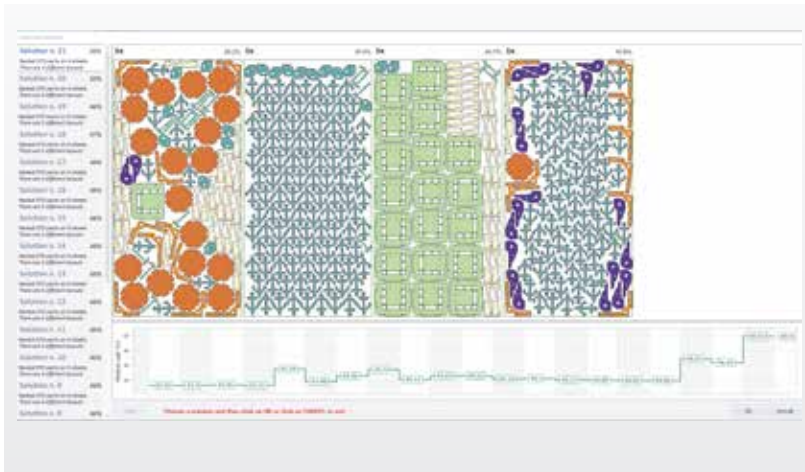

Advanced nesting options with Libellula.CUT



Panasonic servo motors and EtherCAT network type drives

### Standard Equipment Hypertherm®

Table prepared for filter system (automatic closure control), Panasonic Servomotors and drivers, Automatic burner height control with Hypertherm THC sensor, Cutting torch with magnetic coupling and crash sensor, Hypertherm Edge Connect CNC-Unit, 19" Touchscreen from ELO, Ethercat-E, Laserpointer, Eckelmann IBE Software cncCUT Nest, Eckelmann IBE Software cncCUT Epost

### Standard Equipment Kjellberg®

Table prepared for filter system (automatic closure control), Panasonic Servomotors and drivers, Automatic burner height control from Eckelmann, Cutting torch with magnetic coupling and crash sensor, Eckelmann CNC-Unit, 19" Touchscreen from ELO, A-Modul from Beckhoff, Laserpointer, Eckelmann IBE Software cncCUT Nest, Eckelmann IBE Software cncCUT Epost



Optimum track speed even for fine contours and tight radii

Options	Part No.
• Powermax 105 Plasma source	253405
• Maxpro 200 Plasma source	253406
• XPR 170 Core Plasma source	253407
• XPR 170 VWI Plasma source	253408
• XPR 170 Optimix Plasma source	253409
• XPR 300 Core Plasma source	253410
• XPR 300 VWI Plasma source	253411
• XPR 300 Optimix Plasma source	253412
• CutFire 100i Plasma source	253391
• Smart Focus 130 Plasma source	253088
• Smart Focus 170 Plasma source	253652
• Smart Focus 200 Plasma source	253089
• Smart Focus 300 Plasma source	253090
• Smart Focus 400 Plasma source	253091
• Q 1500 Allgas Plasma source	253864
• Q 3000 Allgas Plasma source	253865

Specifications Compact		1530 K	1530 H	2040 K	2040 H	3060 K	3060 H
<b>Working area</b>							
Cutting Width	mm	1.500	1.500	2.000	2.000	3.000	3.000
Cutting length	mm	3.000	3.000	4.000	4.000	6.000	6.000
Table height	mm	600	600	600	600	600	600
Table load capacity	kg/m <sup>2</sup>	410	410	410	410	410	410
Rapid feed	mm/min	18.000	18.000	18.000	18.000	18.000	18.000
Weight (without plasma source)	kg	2.250	2.250	3.550	3.550	8.000	8.000
Plasma source		Kjellberg	Hypertherm	Kjellberg	Hypertherm	Kjellberg	Hypertherm
Part No.		144035	144031	144036	144032	144037	144033



See this machine  
in action on  
YouTube 



- Compact design with guides integrated into the table frame
- Plasma cutting system for personal use providing high value at a lost cost
- Careful selection of the optimum components ensures that the same cutting functionality is available as in large plasma cutting systems
- Machine can be moved and transported in its fully assembled state
- The drives on both sides of the machine bridge and the drive of the X-slide along the machine bridge are carried out in a permanently precise manner by helical rack and pinion.
- The machine has a segment-wise suction of the working surface, whereby the respective suction flap is opened mechanically by the machine bridge passing.
- The distance between plasma cutting nozzle and plate surface is maintained by the Z axis height control; height control is regulated by an electric arc
- Plasma cutter head with collision guard



In plasma cutting, the electric arc between electrode and workpiece is constricted by a cutting nozzle so that a plasma beam of high energy density is generated as an effective cutting tool for metals.

### Standard Equipment Hypertherm®

Table prepared for filter system (mechanical closure), Panasonic Servomotors and drivers, Automatic burner height control with Hypertherm THC sensor, Cutting torch with magnetic coupling and crash sensor, Hypertherm Edge Connect CNC-Unit, 19" Touchscreen, Ethercat-E, Laserpointer, Eckelmann IBE Software cncCUT Nest, Eckelmann IBE Software cncCUT Epos

### Standard Equipment Kjellberg®

Table prepared for filter system (automatic closure control), Panasonic Servomotors and drivers, Automatic burner height control from Eckelmann, Cutting torch with magnetic coupling and crash sensor, Eckelmann CNC-Unit, 19" Touchscreen from ELO, A-Modul from Beckhoff, Laserpointer, Eckelmann IBE Software cncCUT Nest, Eckelmann IBE Software cncCUT Epos



New software feature, improved hardware, and integrated Hypertherm® cutting technology

### Options

	Part No.
• Powermax 105 Plasma source	253405
• CutFire 100i plasma source	253391

For additional options for this machine, visit our website

### Specifications AirPro

		1530 K	1530 H
<b>Working area</b>			
Cutting Width	mm	1.550	1.550
Cutting length	mm	3.050	3.050
Table height	mm	600	600
Table load capacity	kg/m <sup>2</sup>	345	345
Rapid feed	mm/min	15.000	15.000
Weight (without plasma source)	kg	1.700	1.700
Plasma source		Kjellberg	Hypertherm
Part No.		144034	144030

## Hypertherm® Plasma Source

These plasma sources fulfill all the needs of a powerful, heavy-duty plasma cutting system - they are simple, reliable and unbelievably productive

- Superior cut quality and durability
- Maximized productivity
- Minimized operating cost
- Unsurpassed process flexibility



### XPR300™

Unmatched performance and low operating cost

The new XPR300™ is known for its superior X-Definition™ cutting quality in plain carbon steel, steel alloys, and aluminum. Its much higher cutting speed leads to drastically increased productivity, while operating cost are reduced by more than 50%.

#### 3 Gas Console Designs:

- Core™ Console
- Vented Water Injection™ (VWI) Console
- OptiMix™ Console  
(incl. patent-pending Vented Water Injection™ (VWI) technology)

Plasma Source		105	MaxPro200	XPR 170	XPR300™*
<b>Cutting capacity in plain carbon steel</b>					
Virtually burr-free	mm	-	20	-	-
Hole cutting capacity in production	mm	16/22	32	40	45
Cut-off (edge-start)	mm	25/38	50	60	80
<b>Cutting capacity in steel alloy</b>					
Hole cutting capacity in production	mm	-	25	22	38
Cut-off (edge-start)	mm	-	50	38	75

\* with OptiMix™ Console



## EDGE® Connect CNC System

- The optimum control for any requirements
- CNC Software Phoenix® Version 10
- New software functions, improved hardware, and integrated Hypertherm® cutting expertise  
Easy to operate, absolutely reliable and powerful
- With the CutPro Wizard, even new users can cut high-quality parts in less than five minutes without training.





### Plasma cutting from 1 to 100 mm

The Smart Focus series features a compact design and requires only a few settings to achieve excellent cutting results – even under the most demanding conditions.

All systems of the Smart Focus series feature the tried-and-tested Contour Cut technology for structural steel cutting.

Small contours, narrow lands and holes with a diameter/material thickness ratio of 1:1 can be cut with superior quality. Using Contour Cut Speed, contours can be cut up to 50% faster.

### Advantages

- Superior cutting quality (even in stainless steel)
- Tight perpendicularity tolerance
- User-friendly and low maintenance
- Low cutting costs
- Automatic gas console

Specifications*	Smart Focus 130	Smart Focus 170	Smart Focus 200	Smart Focus 300	Smart Focus 400
<b>Power supply</b>					
Cutting current	35 – 130 A	35 – 170 A	35 – 200 A	35 – 300 A	35 – 400 A
Marking current	10 – 50 A	10 – 50 A	10 – 50 A	10 – 50 A	10 – 50 A
Cycle time	100 %	100 %	100 %	100 %	100 %
<b>Cutting capacity</b>					
Maximum	40 mm	50 mm	60 mm	80 mm	100 mm
Recommended	1 – 32 mm	1 – 35 mm	1 – 40 mm	1 – 60 mm	1 - 70 mm / stainless steel 70 mm/ structural steel 60 mm
Plunge-cut	25 mm	30 mm	30 mm	40 mm	50 mm
Plasma gases	O <sub>2</sub> , Ar/H <sub>2</sub> , N <sub>2</sub> , air	O <sub>2</sub> , Ar/H <sub>2</sub> , N <sub>2</sub> , air	O <sub>2</sub> , Ar/H <sub>2</sub> , N <sub>2</sub> , air	O <sub>2</sub> , Ar/H <sub>2</sub> , N <sub>2</sub> , air	O <sub>2</sub> , Ar/H <sub>2</sub> , N <sub>2</sub> , air
Marking gases	Ar, N <sub>2</sub>	Ar, N <sub>2</sub>	Ar, N <sub>2</sub>	Ar, N <sub>2</sub>	Ar, N <sub>2</sub>
Overall dimensions (L x W x H)	1030 x 570 x 1260 mm	1030 x 680 x 1450 mm	1030 x 680 x 1450 mm	1030 x 680 x 1450 mm	1030 x 680 x 1450 mm
Weight	266 kg	388 kg	388 kg	488 kg	563 kg

## Water-Jet B

Cutting solution for virtually any type of material



- Very rigid dual-drive machine bridge
- Rigid frame construction (sides are made of stress-free annealed and milled monoblocks, which are fastened with pins during machine setup)
- High-quality linear guides on all axes
- Ground and hardened helical gears on Y and X axes, plus high-quality preloaded ball screws on Z axis
- Servo-motor drive on X / Y / Z axis
- Electronically monitored central lubrication system
- Stand-alone cutting table with high load capacity
- Exchangeable support grid with galvanized (standard) or stainless steel (option) slats
- The standard laser pointer simplifies workpiece alignment on the support table for optimized sheet metal utilization
- The abrasive sand is held in a 250 kg storage container and transferred automatically via air pressure to a dosing unit



Cutter head and abrasives system are optimally adapted for the high-pressure system BFT high-pressure pump with ALLFI cutter head and abrasives system (shown) KMT high-pressure pump with ACTIVE IDEII/PRO and KMT FEEDLINE



Totally enclosed moving units to protect against ingress of water and dust

### Control BECKHOFF CX5130

- The CX5130 has an Intel Atom® multicore processor with 1.75 GHz, real multi-core technology in the segment of compact embedded PCs
- Two independent, Gigabit-capable Ethernet interfaces as well as four USB 2.0 and one DVI-I interfaces are available
- The CX5130 is characterized by low power consumption and no fan
- Powerful Contronest drives round out the powerful and reliable control package

### Standard Equipment

separate cutting table, support grid with galvanized slats, CONTRONEST CNC Control, laser pointer, abrasive tank 250 kg, swiveling control panel attached to the machine, electronic hand-wheel, operating manual and programming instructions

### Options

### Part No.

• BFT High pressure pump Ecotron 40.37, 3800 bars, 50HP	253564
• BFT High pressure pump Servotron 40.37	253364

For additional options for this machine, visit our website.

### CAM-Software ControNest

- Easy to operate CAM software
- ControNest was specially developed for cutting machines
- The software includes an embedded CAM module, with which CAD drawings, nesting and material databases can be imported, which means no expensive additional CAM software is required

Specifications Water-Jet B		2010	2040	2060	3015	3020	3040	3060	3080
<b>Working area</b>									
Cutting range	mm	2.050x 1.050	2.050x 4.050	2.050x 6.050	3.050x 1.550	3.050x 2.050	3.050x 4.050	3.050x 6.050	3.050x 8.050
Table load capacity	kg/m <sup>2</sup>	1.500	1.500	1.500	1.500	1.500	1.500	1.500	1.500
<b>Travels</b>									
Travel Z-axis	mm	200	200	200	200	200	200	200	200
<b>Rapid feed</b>									
Rapid feed X-, Y-, Z- axis	mm/min	20.000	20.000	20.000	20.000	20.000	20.000	20.000	20.000
<b>Feed</b>									
Work feed	mm/min	0 - 20.000	0 - 20.000	0 - 20.000	0 - 20.000	0 - 20.000	0 - 20.000	0 - 20.000	0 - 20.000
<b>Accuracies</b>									
Positioning accuracy	mm	± 0,06	± 0,06	± 0,06	± 0,06	± 0,06	± 0,06	± 0,06	± 0,06
Repeatability	mm	± 0,05	± 0,05	± 0,05	± 0,05	± 0,05	± 0,05	± 0,05	± 0,05
<b>Measures and weights</b>									
Overall dimensions (length x width x height)	m	3,45x2 x2,4	3,45x5 x2,4	3,45x7 x2,4	4,45x2,5 x2,4	4,45x3 x2,4	4,45x5 x2,4	4,45x7 x2,4	4,45x9 x2,4
Weight without water	kg	2.420	4.960	6.620	3.370	3.930	5.950	8.310	10.500
Part No.		166740	166743	166744	166741	166742	166745	166746	166747



- Very rigid dual-drive machine bridge
- Rigid frame construction (sides are made of stress-free annealed and milled monoblocks, which are fastened with pins during machine setup)
- high-quality linear guides on all axes
- Ground and hardened helical gears on Y and X axes, plus high-quality preloaded ball screws on Z axis
- Servomotoren und Präzisionsgetriebe stellen die ausgezeichnete Positionier- und Wiederholgenauigkeit sicher
- Totally enclosed moving units to protect against ingress of water and dust
- Electronically monitored central lubrication system
- Stand-alone cutting table with high load capacity
- Exchangeable support grid with galvanized (standard) or stainless steel (option) slats
- The standard laser pointer simplifies workpiece alignment on the support table for optimized sheet metal utilization
- The abrasive sand is held in a 250 kg storage container and transferred automatically via air pressure to a dosing unit

### 5-axis cutting system

- chamfering up to 60°
- TaperControl - cutting angle correction feature
- 5-axis cutting kinematics with high dynamics and precision
- Endless Rotating = no contour disruption and no repeat plunge-cut required = time and cost savings



Powerful CNC with ergonomic design

## FAGOR CNC 8065

- **CNC CONTROL UNIT AND CAD/CAM-SOFTWARE**
- Powerful CNC with ergonomic design
- New series with touchscreen monitor, integrated mouse and USB port
- Rugged design with component technology that meets IP65 (NEMA12) standards
- Higher precision: Pre-programmed travel direction reversals are analyzed up front in order to adjust machining conditions according to the machine dynamics

Specifications Water-Jet 5X		2040	2060	3015	3020	3040	3060	3080
<b>Working area</b>								
Cutting capacity (2D)	mm	2.000x	2.000x	3.000x	3.000x	3.000x	3.000x	3.000x
		4.000	6.000	1.500	2.000	4.000	6.000	8.000
Cutting capacity 5 axes	mm	1.550x	1.550x	2.550	2.550x	2.550x	2.550x	2.550x
		3.500	5.550	1.050	1.550	3.550	5.550	7.550
Table load capacity	kg/m <sup>2</sup>	1.500	1.500	1.500	1.500	1.500	1.500	1.500
<b>Travels</b>								
Travel Z-axis	mm	150	150	150	150	150	150	150
<b>Rapid feed</b>								
Rapid feed X-, Y-, Z- axis	mm/min	20.000	20.000	20.000	20.000	20.000	20.000	20.000
<b>Feed</b>								
Work feed	mm/min	0 - 20.000	0 - 20.000	0 - 20.000	0 - 20.000	0 - 20.000	0 - 20.000	0 - 20.000
<b>Accuracies</b>								
Positioning accuracy	mm	± 0,02	± 0,02	± 0,02	± 0,02	± 0,02	± 0,02	± 0,02
Repeatability	mm	± 0,01	± 0,01	± 0,01	± 0,01	± 0,01	± 0,01	± 0,01
<b>Measures and weights</b>								
Overall dimensions (length x width x height)	m	3,45x5	3,45x7	4,45x2,5	4,45x3	4,45x5	4,45x7	4,45x9
		x2,4	x2,4	x2,4	x2,4	x2,4	x2,4	x2,4
Weight without water	kg	4.960	6.620	3.370	3.930	5.950	8.310	10.500
Part No.		166753	166754	166751	166752	166755	166756	166757

## Standard Equipment

5-Axis cutting system, IGEMS Softwarepackage, Network Connection for Fagor CNC, separate cutting table, support grid with galvanized slats, CNC control FAGOR 8065, laser pointer, abrasive tank 250 kg, swiveling control panel attached to the machine, electronic hand-wheel, operating manual and programming instructions

Options	Part No.
• BFT High pressure pump Ecotron 40.37, 3800 bars, 50HP	253564
• BFT High pressure pump Servotron 40.37	253364
• Starter set BFT 40.30/40.37/40.37+	166213

For additional options for this machine, visit our website.

## Software

- The IGEMS Software package allows you to create and import 2D and 3D drawings, define tool paths, and arrange nesting layouts

# Laser - Waterjet - Plasma

## Only 5 Steps to Find the Perfect Cutting System

Which cutting process is right for my requirements? What size unit would I need? A guide for the selection of your cutting system - and how the KNUTH Metalworking Center supports your decision making.



Please answer the following 5 questions and move one step closer to deciding on your ideal cutting system.

### 1. What internal requirements does the system have to fulfill?

The KNUTH Consultant Team works together with you to clarify all aspects of your processes:

For what tasks would you use a cutting system?

Are there other machining processes in your company for which a cutting system would be the better alternative? Where are possibilities for process optimization?

How do you assess the development of cutting tasks in terms of technical requirements and utilization?

### 2. Which process is right for my requirements?

Very important criteria in the selection process are expert consultation as well as technical preparation and assistance. The right process, the right dimension and precise alignment with your needs. This involves a systematic comparison of cutting technologies. We compare requirements like material and thickness of the original material, geometry of cutting contours and the amount of pieces to be processed.

### 3. Will the new machine increase the competitiveness of my company?

The main focus is not the purchase price, but to strike the right balance between productivity, availability, operation and maintenance costs. An objective evaluation of the cost-effectiveness will show that the targeted part production cost often does not meet the minimum requirement even when using the smallest possible cutting system. More wear and tear and slower production speeds result from the use of such a small system that continuously is stretched to its limits. Ultimately, the part production cost will be much higher than it would be with a more generously sized system.

We offer you trial machining of a sample so you can get solid data for your planning. The right price and customized financing ensure that your investment pays off and you remain competitive.



**ACE Laser:**  
Complete solutions for your cutting tasks



**Plasma-Jet Options:** Tube cutting systems, cutting heads for bevels and oxy-fuel cutting



**Water-Jet 2D and 5-axis machines,**  
cutting solutions for any material

We will find the perfect cutting technology, cutting machine size and technical equipment for you.

#### 4. When can I start seeing the benefits of the new technology?

To realize the full potential of production systems and deliver a quick return on investment, a smooth launch is absolutely vital. With the StartUp package, our team guarantees speedy commissioning, instruction and training. Even after production starts, we always will be there to assist you by sharing knowledge and experience, either in person or remotely.

#### 5. Do I have the right service partner?

Characteristics of the right service partner are high availability and increased reliability. You are in production for the long run. That is why you should make sure when buying, that the right support will be available for the long run. KNUTH will service your cutting system over its entire life cycle.

When it comes to **laser cutting systems**, KNUTH recommends the use of fiber lasers with their superior cutting power and unsurpassed energy efficiency compared to CO2 laser systems. The fiber laser's wavelength is suitable for cutting reflective metals, like copper, aluminum or brass.

With **water-jet cutting systems** virtually all materials can be cut, and there are no thermal effects on the material. Additionally, it can cut through thick-

nesses that would be impossible to sever with laser or plasma cutting systems, and a much higher accuracy is possible in very thick materials.

**Plasma cutting systems** are ideal for cutting metals like stainless steel, aluminum and copper in various thicknesses. Plasma is faster in thicker materials and more cost-efficient than laser processes.

The KNUTH Consultant Team consists of expert sales consultants and engineers with extensive experience in the metalworking industry that can help you find the perfect process for your business. Consultation appointments include sample pieces and live machining of samples.

# Shears

**See for yourself live:** Many models are in stock or can be viewed and tried out at a user's location near you. Make a demonstration appointment! [info@knuth.com](mailto:info@knuth.com)



## Experience our machines in action!

With our YouTube channel KNUTH Machine Tools, you stay up to date with all the news and developments.



Hydraulic guillotine shears

**KHT**

Cutting length **3000 - 6000 mm**

Cutting capacity **6 - 16 mm**

Powerful for large, narrow, thick and thin sheets  
thanks to variable cutting angle

from page 240 onwards





## Motorized guillotine shears

### KMT

Cutting length **1.250 - 3.050 mm**

Cutting capacity **2 - 4 mm**

The economic and powerful guillotine shears series for every workshop

from page 244 onwards



## Ironworker

### HPS H

Pressure capacity **45 - 175 t**

Measuring length **320 - 610 mm**

Universal machining at 5 work stations: punching, cutting, notching

Page 248 / 249



## Notching machine

### KAM

Cutting length **250 mm**

Cutting thickness **6,5 mm**

Little space required, automatic cutting gap adjustment and clean cuts

Page 250

## Manual Swing-Beam Shears

### KHS E

Cutting length **1.040 mm**

Cutting thickness **1,5 mm**

Robust manual swing-beam shears for easy and precise cutting of plates up to 1,5 mm thick

Page 251





KHT H 3010 CNC with optional accessories is shown

**These guided hydraulic plate shears with CNC-controlled back gauge, kerf and cutting angle combine high quality and reliability with a user-friendly design**

### Machine Frame

- The very rigid and heavy machine frame has been welded to tight tolerances and annealed
- All components subject to tensile loads have been carefully constructed and designed with large radii to permanently eliminate the risk of cracking
- The table features a bottom cutter mount and cutter bar and has been designed for minimal torsion and optimum load distribution
- All components were treated in a modern paint and drying system and feature two coats of paint, each coat with a minimum thickness of 60 micron

### Material Support

- The large work table features roller balls and a rigid lateral angular stop for easy handling and safe plate alignment
- Long, sturdy support arms safely hold large plates

### Hydraulics

- Polished pistons on both hydraulic cylinders feature superior 2 micron surface grades, ensuring a long seal life
- Cylinder bodies are forged from high-strength SAE 1040 material
- The entire hydraulic system is reliable, low-maintenance and easy to service
- During the cut, hydraulically regulated hold-downs ensure steady fixation of the sheet metal plate close to the cut-line

### Back Gauge and Control

- Length, thickness, and strength of the plate material can easily be entered by the user into the programmable control unit, which then automatically will select the appropriate positions for kerf, cutting angle and cutting length
- The back gauge system is very robust and perfectly suited for rough production environments
- Linear guides and preloaded ball screws are mounted in a protective enclosure



KHT H 3010 CNC is shown

### Equipment

- Electric components made by renowned manufacturers ensure problem-free operation and high availability
- Upper and lower knives suitable for stainless steel
- The machine is operated via a foot pedal with emergency stop switch, and the pedal can be located wherever it is most convenient

### Safety

- Safety features are based on the latest CE regulations
- The rear-mounted light barrier system protects the work area

### Standard Equipment

Cybele Touch 8 controller, CNC controlled blade gap adjustment, CNC controlled cutting length adjustment, CNC controlled rake angle adjustment, hand safety guard, cut-line lighting, material support table with rollers, motorized rear stop 1000 mm, side stop with scale and T-slot plus tilt stop ( L= 1000 mm ), 2 support arms, safety system for work area, foot pedal with E-stop switch, standard upper and lower knives, operator manual

Specifications KHT H CNC		3006	3010	3013	3016	4006	4010	4013	4016
<b>Working area</b>									
Plate thickness (max.)	mm	6	10	13	16	6	10	13	16
Working length	mm	3.080	3.080	3.080	3.080	4.080	4.080	4.080	4.080
Throat	mm	150	150	150	150	150	150	150	150
Cutting angle	deg	0,3 - 2	0,3 - 2	0,3 - 2,3	0,3 - 2,5	0,3 - 2	0,3 - 2	0,3 - 2,3	0,3 - 2,5
Strokes per minute	H/min	20	19	19	14	17	18	16	13
Hold-down	Pieces	13	16	16	18	20	20	19	20
<b>Back Gauge</b>									
Rear stop	mm	1.000	1.000	1.000	1.000	1.000	1.000	1.000	1.000
Feed speed X-axis	mm/min	100	100	100	100	100	100	100	100
<b>Front Support Arms</b>									
Number of support arms	Pieces	3	3	3	3	4	4	4	4
Length of support arms	mm	900	900	900	900	900	900	900	900
<b>Drive capacity</b>									
Motor rating main drive	kW	11	22	30	37	11	22	30	37
Hydraulic tank volume	l	150	250	250	350	150	250	250	350
<b>Measures and weights</b>									
Overall dimensions (length x width x height)	m	3,9x2,08 x1,95	3,92x2,12 x2,13	3,94x2,15 x2,26	4x2,2 x2,42	4,94x2,1 x2,08	4,96x2,18 x2,3	4,98x2,2 x2,38	5x2,25 x2,63
Weight	kg	7.000	9.500	11.500	15.300	9.700	13.750	16.400	22.800
Part No.		183260	183261	183262	183263	183264	183265	183266	183267



See this machine  
in action on  
YouTube



The new KHT H NC series features high machining quality and reliability, is easy to handle and provides superior cutting performance.

### Machine Frame

- The machine frame is made of a high-precision, stress-relieved steel weldment and features rigid sliding block guides
- Motorized adjustments of kerf and knife angle allow for ideal settings optimized for the sheet metal plate to be processed
- All components were treated in a modern paint and drying system and feature two coats of paint, each coat with a minimum thickness of 60 micron

### Material Support

- The large work table features roller balls and a rigid lateral angular stop for easy handling and safe plate alignment
- Long, sturdy support arms safely hold large plates

### Hydraulics

- Polished pistons on both hydraulic cylinders feature superior 2 micron surface grades, ensuring a long seal life

- Cylinder bodies are forged from high-strength SAE 1040 material
- During the cut, hydraulically regulated hold-downs ensure steady fixation of the sheet metal plate close to the cut-line

### Back Gauge and Control

- Linear guides and preloaded ball screws are mounted in a protective enclosure
- The user-friendly NC positions the back gauge precisely for single cuts or for program runs

### Equipment

- Upper and lower knives suitable for stainless steel
- The machine is operated via a foot pedal with emergency stop switch, and the pedal can be located wherever it is most convenient

### Safety

- Safety features are based on the latest CE regulations

**Options**

	Part No.
• Adjustable angle stop 0-180°	253283
• Oil Heater	253276
• Oil cooler	253277
• Manual Centralized Lubrication System	253278
• Automatic Centralized Lubrication System	253279
• Front arm support with L = 1.500 mm for KHT H NC	253280
• Front arm support with L = 2.000 mm for KHT H NC	253281
• Front arm support with L = 3.000 mm for KHT H NC	253282
• Fixed type pneumatic sheet support for KHT H NC 4013	253501
• Modular type pneumatic sheet support for KHT H NC 4013	253500

**Standard Equipment**

operator instructions, foot pedal, standard upper and lower tool, motorized kerf adjustment, Motorized back-gauge adjustment, Motorized rack angle adjustment, Full length flip-up finger guard, Light with shadow line, front support arms, BRL 401.2 NC Control Unit

**Specifications KHT H NC**

		2006	2506	3006	3008
<b>Working area</b>					
Plate thickness (max.)	mm	6	6	6	8
Working length	mm	2.080	2.580	3.080	3.080
Cutting angle	deg	0,3 - 2	0,3 - 2	0,3 - 2	0,3 - 2
Hold-down	Pieces	10	12	13	16
Hold-down capacity	t	15	15	16	20
<b>Back Gauge</b>					
Rear stop	mm	1.000	1.000	1.000	1.000
Feed speed X-axis	mm/min	100	100	100	100
<b>Front Support Arms</b>					
Number of support arms	Pieces	2	3	3	3
Length of support arms	mm	900	900	900	900
<b>Drive capacity</b>					
Motor rating main drive	kW	11	11	11	22
Hydraulic tank volume	l	160	160	160	350
<b>Measures and weights</b>					
Overall dimensions (length x width x height)	m	2,78x2,8x1,85	3,3x2,8x1,87	3,83x2,8x1,96	3,84x2,8x2,12
Weight	kg	4.900	5.700	7.000	8.450
Part No.		184200	184201	184202	184203

**Specifications KHT H NC**

		3010	3013	4006	4010	4013
<b>Working area</b>						
Plate thickness (max.)	mm	10	13	6	10	13
Working length	mm	3.080	3.080	4.080	4.080	4.080
Cutting angle	deg	0,3 - 2	0,3 - 2,3	0,3 - 2	0,3 - 2	0,3 - 2,3
Hold-down	Pieces	16	16	20	20	19
Hold-down capacity	t	20	38	25	25	45
<b>Back Gauge</b>						
Rear stop	mm	1.000	1.000	1.000	1.000	1.000
Feed speed X-axis	mm/min	100	100	100	100	100
<b>Front Support Arms</b>						
Number of support arms	Pieces	3	3	4	4	4
Length of support arms	mm	900	900	900	900	900
<b>Drive capacity</b>						
Motor rating main drive	kW	22	30	11	22	30
Hydraulic tank volume	l	350	350	160	350	350
<b>Measures and weights</b>						
Overall dimensions (length x width x height)	m	3,85x2,9x2,14	3,94x2,94x2,26	4,94x2,8x2,08	4,96x2,9x2,3	4,98x2,9x2,38
Weight	kg	9.200	11.500	9.700	13.750	16.400
Part No.		184204	184205	184206	184207	184208



KMT B 1254

- Manual back gauge
- High cutting power



Manual back gauge with counter

- The machine frame is made of a rigid, solid steel weldment
- A rubber-coated hold-down automatically fixates the plate
- A small knife angle ensures cut accuracy
- The rigid side angle stop simplifies alignment of the plate to the cut line

**Standard Equipment**

foot pedal, Side angle stop, support arms, automatic hold-down device, cut-line lighting, manual rear stop, operator instructions

**Specifications**

		<b>KMT B 1253</b>	<b>KMT B 1254</b>	<b>KMT B 2052</b>	<b>KMT B 2053</b>
Structural steel plate thickness	mm	0,8 - 3	0,8 - 4	0,8 - 2	0,8 - 3
Working length	mm	1.250	1.250	2.050	2.050
Cutting angle	deg	2	2,4	2	2
Strokes per minute (automatic mode)	H/min	30	30	30	30
Work table height	mm	830	830	830	830
Number of support arms	Pieces	2	2	3	3
Rear stop	mm	630	630	630	630
Motor rating main drive	kW	3	4	3	4
Overall dimensions (length x width x height)	m	1,69x1,48x1,1	1,72x1,6x1,19	2,5x1,67x1,1	2,5x1,6x1,19
Weight	kg	850	1.185	1.300	1.520
Part No.		133640	133642	133643	133641



KMT B 2552 NC is shown

- **Controlled back gauge**
- **4.3" touchscreen**
- **Reversible upper and lower knife**



The rugged back gauge stands up to every day production challenges

- The rigid side angle stop simplifies alignment of the plate to the cut line
- The PLC back-gauge control with 4.3" touchscreen features a user-friendly graphic interface for quick and easy programming
- The backgauge is driven by a servo motor, which significantly improves positioning and repeatability accuracy
- A plate hold-up fixture prevents any overhang of the plate in front of the back gauge to ensure maximum accuracy and quality of every cut, even in thin plates

### Standard Equipment

pcl control, work lamp, safety guard with power off after open door, Back gauge with 4,3" Touchscreen, foot pedal, cut-line lighting, lateral stop, Support arms with material support balls, powered rear stop, hold-down, pneumatic sheet hold-up device, Safety cover Working area Backgauge, operator instructions

### Specifications

		KMT B 1304 NC	KMT B 2552 NC	KMT B 2554 NC
Structural steel plate thickness	mm	0,8 - 4	0,8 - 2	0,8 - 4
Working length	mm	1.300	2.550	2.550
Cutting angle	deg	2,4	1,6	1,8
Strokes per minute (automatic mode)	H/min	30	30	30
Work table height	mm	830	830	830
Number of support arms	Pieces	5	5	5
Rear stop	mm	630	630	630
Motor rating main drive	kW	4	4	7,5
Overall dimensions (length x width x height)	m	1,75x1,82x1,19	3x1,78x1,24	3,05x1,87x1,26
Weight	kg	1.355	1.900	2.500
Part No.		133652	133653	133650



- The machine frame is made of a very rigid, solid steel weldment
- The upper knives are reversible for use of both sides, and the lower knives feature 4 cutting edges
- A rigid, continuous hold-down fixes the sheet metal plate right in front of the cut line
- The rigid side angle stop simplifies alignment of the plate to the cut line
- The mobile foot switch gives the operator added flexibility and both hands are free for handling the workpiece
- The back gauge can be positioned precisely via a hand-wheel

### Standard Equipment

foot pedal, cut-line lighting, lateral stop, support arms with T-slots and tilting stop, manual 750 mm backgauge, ball bearing front table, light curtain, top blade with 2 sides, Full length flip-up finger guard, operator instructions

### Specifications KMT S

		1353	1553	2053	2552	3052
Structural steel plate thickness	mm	0,1 - 3	0,1 - 3	0,1 - 3	0,1 - 2,5	0,1 - 2
Plate thickness stainless steel	mm	1,5	1,5	1,5	1,25	1
Working length	mm	1.350	1.550	2.050	2.550	3.050
Cutting angle	deg	2,32	2,05	1,58	1,3	1,3
Work table height	mm	840	840	840	840	840
Work table depth	mm	390	390	390	390	390
Number of support arms	Pieces	2	2	3	3	4
Support arms	mm	940	940	940	940	940
Strokes per minute	H/min	34	34	34	34	34
Rear stop	mm	750	750	750	750	750
Motor rating main drive	kW	3	3	4	4	4
Overall dimensions (length x width x height)	m	1,93x2,15x1,312	1,5x2,15x1,312	2,7x2,15x1,31	3,2x2,15x1,31	3,7x2,15x1,31
Weight	kg	1.250	1.550	1.750	1.950	2.200
Part No.		133610	133611	133612	133613	133614





Material support rollers are recessed in the table for easy workpiece handling

- The machine frame is made of a very rigid, solid steel weldment
- The upper knives are reversible for use of both sides, and the lower knives feature 4 cutting edges
- A rigid, continuous hold-down fixes the sheet metal plate right in front of the cut line
- The rigid side angle stop simplifies alignment of the plate to the cut line
- The mobile foot switch gives the operator added flexibility and both hands are free for handling the workpiece
- The motorized back gauge ensures precise positioning in automatic, semi-automatic and manual modes

### Standard Equipment

BRL NC controller, motorized rear stop (750 mm), manual blade gap adjustment, foot pedal, cut-line lighting, light curtain, lateral stop, support arms with T-slots and tilting stop, ball bearing front table, top blade with 2 sides, Full length flip-up finger guard, operator instructions

### Specifications KMT S

		2054 NC	2554 NC	3054 NC
Structural steel plate thickness	mm	0,1 - 4	0,1 - 4	0,1 - 4
Plate thickness stainless steel	mm	2	2	2
Working length	mm	2.050	2.550	3.050
Cutting angle	deg	1,3	1,3	1,3
Work table height	mm	810	810	810
Work table depth	mm	455	455	455
Number of support arms	Pieces	3	3	4
Support arms	mm	940	940	940
Strokes per minute	H/min	29	29	29
Rear stop	mm	750	750	750
Motor rating main drive	kW	7,5	7,5	7,5
Overall dimensions (length x width x height)	m	2,7x2,15x1,45	3,2x2,15x1,45	3,7x2,15x1,45
Weight	kg	3.000	3.500	4.000
Part No.		132210	132211	132212



HPS 65 H is shown



See this machine  
in action on  
YouTube



### Flat Steel Cutters

- For strip steel, flat steel, wide flat steel
- table with angular and linear stops
- Adjustable hold-down
- lower knife provides 4 cutting edges

### Angular Profile Steel Cutters

- For angle steel sections
- Cut angle 90° and 45°
- Adjustable material guide plate

### Rod Steel Station

- For round and square steel
- Robust material guide plate

### Back Gauge

- Including swivel boom
- For use on Flat Steel, Angular Steel and Rod Steel Stations
- The HPS H 45 and HPS H 60 come with a manual back gauge
- Electric back gauges for automatic cut activation are provided on the HPS 65 H, HPS 85 H, HPS 115 H, HPS 175 H

### Hole Punch Station

- For punching round holes and slots in sheet metals, flat steel and U-section steel
- Table with adjustable angular stops
- infinitely variable stroke adjustment
- Premium Kingsland tools
- Hydraulic overload protection

### Notching Station

- Rigid support table with adjustable stops

### Standard Equipment

easy replaceable punch holder, stamps and dies, angle cutting blade, flat bar cutting blade, notching blade, solid bar cutting blade, back gauge, foot pedal with emergency stop button, hook spanner wrench, work lamp



Back gauge with automatic cut activation



Notching station with safeguard



- Models HPS 45H and HPS 60 H feature a powerful hydraulic cylinder
- Models HPS 65 H, HPS 85 H, HPS 115 H and HPS 175 feature 2 hydraulic cylinders allowing simultaneous operation at 2 stations



Hole punch station featuring large support table



Compact design and excellent rigidity

## Specifications HPS

		45 H	60 H	65 H	85 H	115 H	175 H
<b>Working area</b>							
Number of hydraulic cylinders	Pieces	1	1	2	2	2	2
<b>Punch press</b>							
Pressure force	t	45	60	65	85	115	175
Punch capacity (max.)	mm	22x15	28x15	26x20	33x20	34x26	40x32
Diameter x thickness	mm	38x8	38x11	57x10	57x12	55x16	57x22
Throat	mm	190	225	305	355	405	625
Stroke	mm	35	50	55	80	80	80
Stroke number (at 20 mm stroke)	H/min	20	25	25	25	25	22
Working height	mm	935	935	1.005	1.070	1.070	1.130
<b>Steel cutter</b>							
Cutting capacity flat (max. width)	mm	300x12	300x15	375x15	480x15	600x15	600x20
Cutting capacity flat (max. thickness)	mm	200x15	200x20	300x20	380x20	380x25	380x30
Knife length	mm	320	320	380	485	610	610
Cutting capacity round	mm	30	40	45	50	55	65
Cutting capacity square	mm	25	35	45	50	50	55
Steel cutter working height	mm	940	930	895	930	905	905
<b>Profile cutter</b>							
Cutting capacity 90°	mm	100x100x10	120x120x12	130x130x13	150x150x15	160x160x16	200x200x20
Cutting capacity 45°	mm	60x6	70x7	70x7	80x8	80x8	80x8
Profile cutter working height	mm	1.135	1.130	1.130	1.190	1.190	1.160
<b>Notcher</b>							
Plate thickness (max.)	mm	8	10	10	13	13	16
Width	mm	35	42	45	52	60	65
Depth	mm	100	100	100	100	100	100
<b>Drive capacity</b>							
Motor rating hydraulic pump	kW	4	4	5,5	7,5	11	11
<b>Measures and weights</b>							
Overall dimensions (length x width x height)	m	1,33x0,77 x1,46	1,46x0,77 x1,58	1,69x0,77 x1,76	1,87x0,77 x1,89	2,05x0,77 x2,03	2,81x1,08 x2,21
Weight	kg	1.200	1.400	1.700	2.250	3.150	5.750
Part No.		131180	131181	131182	131183	131184	131185



- Cutting capacity up to 6,5 mm
- Automatic kerf adjustment
- Large work table

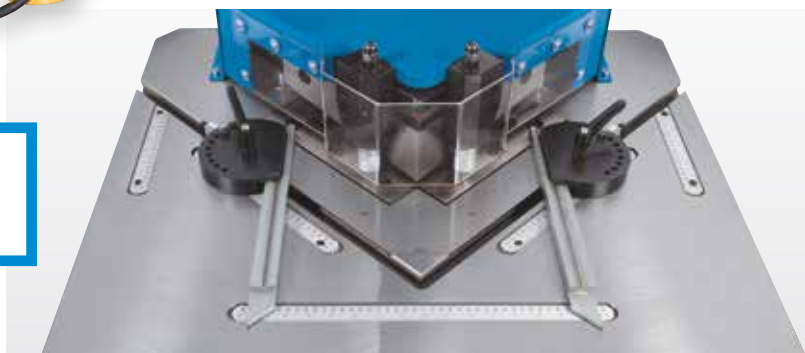

Adjustable clamping lever simplifies safe handling of stops

- The KAM 250 fixed-angle notcher features a compact design and long cutting length
- The powerful hydraulic drive and heavy, rigid construction allow machining of up to 6,5 mm thick plates
- Automatic kerf adjustment simplifies machining operations and minimizes down-times
- The large work table features a 90° slot that runs parallel to the cut line, which can accommodate two indexable angular stops

### Standard Equipment

Footpedal with emergency stop, angle stop, operator manual

### Specifications

### KAM 250

#### Working area

Cutting angle	deg	90
Max cut length	mm	250
Max cut thickness	mm	6,5
Strokes per minute	Pieces	24
Table size	mm	810x750
Motor rating	kW	4
Operating pressure	bar	120

#### Measures and weights

Oil tank capacity	l	35
Overall dimensions (length x width x height)	m	1,01x0,85x1,4
Weight	kg	630
Part No.		130610

Manual Swing-Beam Shears

## KHS E 1000

Robust manual swing-beam shears for easy and precise cutting of plates up to 1,5 mm thick



- large dimensions steelplates sheets can be pushed through
- large steel plates can be pushed through
- simple and solid cast-iron construction
- adjustable cutting stop

### Specifications KHS E 1000

Plate thickness (max.)	mm	1,5
Working length	mm	1.040
Rear stop	mm	0 - 580
Table dimensions	mm	605x1.100
Overall dimens. (length x width x height)	m	1,3x1x1,5
Weight	kg	460
Part No.		132036

Folding Machine

## SBS 1020/2,5 • 1270/2,0

Heavy manual folding machine with segmented upper tool



- for formed component bending
- compression spring for top counterbalance
- cam lock and rebound spring for bending beam counterbalance
- bow handle for bending beam rotation
- adjustable bending angle stop with scale up to 135°
- segmented top beam tools
- segment size:
  - **SBS 1020/2,5:** 25, 30, 35, 40, 45, 50, 75, 100, 150, 200, 270 mm
  - **SBS 1270/2,0:** 25, 30, 35, 40, 45, 50, 75, 100, 150, 200, 250, 270 mm

### Specifications SBS 1020/2,5 1270/2,0

Working length	mm	1.020	1.270
Plate thickness (max.)	mm	2,5	2
Bending bar angle (range)		135°	135°
Overall dimensions	m	1,35x0,85x1,18	1,6x0,9x1,18
Weight	kg	285	330
Part No.		131364	131363

# Bending and forming machines

**See for yourself live:** Many models are in stock or can be viewed and tried out at a user's location near you. Make a demonstration appointment! [info@knuth.com](mailto:info@knuth.com)



## Experience our machines in action!

With our YouTube channel KNUTH Machine Tools, you stay up to date with all the news and developments.



Press brake

**AHK**

Folding length **1.500 - 6.100 mm**

Pressure capacity **60 - 400 t**

Simple operation and programming, variety of tools, high bending capacity and flexibility

from page 254  
onwards



### Hydraulic folding machine

#### HBM

Folding length **2.035 - 3.100 mm**

Bending capacity **4,5 - 6,5 mm**

Perfect dimensionally stable bending that is gentle on the surface

Page 260 / 261



### Manual folding machine

#### SBS

Working length **1.020 - 3.020 mm**

Plate thickness (max.) **1,2 - 2 mm**

Compact folding machine with segmented upper die

Page 251, 262



### Plate rolling machines

#### KRM / RBM

Rolling length **1.050 - 4.100 mm**

Sheet thickness **1,5 - 45 mm**

Very solid bending machine with excellent machining quality

from page 263 onwards



### Tube and profile bending machine

#### KPB

Shaft diameter **30 - 100 mm**

Roller diameter **132 - 315 mm**

Simple and economical tubes and profiles bend into arches or rings

from page 268 onwards



# CNC Press Brake ensures more predictability and shorter production times

Quality and Reliability: KOPA Forstmaschinen uses a KNUTH AHK H 30220 CNC 4x Press Brake in their forest machinery operation.



## KNUTH was convincing

- Fast: On-site appointment with KNUTH representative within 72 hours after customer's initial inquiry
- Provided expert advise on future-oriented machine performance, flexible use, short tooling times
- Service: Referred retired machine to a used machinery dealer
- Reliability: On-time delivery and minimal down-time for machine exchange

“We use forest machinery and cranes with special modifications and retro-fittings to handle lumber from forests, logging and transportation to the saw mills, and from there to building supply and home improvement stores”, explained their Managing Director, Bernd Lachman. KOPA Forstmaschinen was founded 1964 in Kuddewörde in the German state of Schleswig-Holstein. Today they are the oldest highly specialized forest machinery supplier in Germany with three related businesses operated by the Koop family. “We distribute forestry machines made by the Swedish manufacturer, ROTTNE, and we are specialized in building customized Palfinger crane substructures as well as hook loaders and skip loaders. In addition, we are a service representative for IVECO utility vehicles and offer individual solutions for custom vehicles”, added Bernd Lachmann. The company employs 30 people and currently works on more than 20 investment projects.

## Flexible press brake for custom bending

Since July 2020, KOPA uses a KNUTH AHK H 30220 CNC 4x press brake in their workshop, which is mainly used to bend 8 mm to 12 mm thick steel plates. “Since the machine is used by about ten employees of all three businesses, it had to offer a wide spectrum of machining capacities and allow quick retrofitting, easy operation and maximum reliability”, said Lachmann. The company was well aware of KNUTH, who has been known for over 30 years as a reliable machine tool supplier with excellent service and local presence. Within 72 hours of the custo-





Custom crane substructure for a Rottne F15D forestry machine – a power package for high loads and long forwarders



KNUTH Sales Manager, Christoph Ziebarth, and KOPA Managing Director, Bernd Lachmann



Machined component with radius for a guard cover on a timber transporter fuel tank

mer's inquiry, Christoph Ziebarth, Sales Manager for KNUTH Northern Germany, was on site to become familiar with the work processes, space requirements and specific requirements for the new machine. Lachmann gladly accepted the initiation to KNUTH's site in Wasbek, where he and three of his employees checked out the quality and the performance spectrum of the AHK H 30220. Their old machine was referred by KNUTH to a network of used machine dealers, and the replacement of the machine was completed with minimal down-time.

### Reliable Quality and Excellent Service

KOPA was very happy with their investment in the new CNC press brake. With this increased capacity, they were well equipped for machining even thicker plates and well prepared for future challenges and competition from larger companies. Lachmann's employees were shown the operation of the new machine in a one-day training session. Just as their customers trust in them, KOPA also puts their trust in the proven quality of a long-established

family business that will keep the promised delivery dates. If a vehicle arrives, a speedy process is of the essence. Each steel plate for substructures will be manufactured individually. Thanks to the Delem DA69T 3D software recommended by KNUTH, the plates can be machined circular and/or with a radius using the respective male and female dies. "The new press brake resulted in increased speed and reliability of our work processes, plus we enjoy more predictability and shorter production times", commented Bernd Lachmann.

KOPA Forstmaschinen-Handels- u. Reparatur GmbH  
 Drosseleck 21, 22958 Kuddewörde  
 Tel. +49 (0) 4154 3069  
[www.kopa-forstmaschinen.de/](http://www.kopa-forstmaschinen.de/)

For more machines of this series,  
visit our website



See this machine  
in action on  
YouTube 



Shown with optional equipment

### • Machine Frame and Male Die

- The machine frame is made of a high-precision, stress-relieved steel weldment
- All components subject to tensile loads have been carefully constructed and designed with large radii to eliminate the risk of welding cracks
- All components were treated in a modern paint and drying system and feature two coats of paint, each coat with a minimum thickness of 60 micron

### Work Area

- A large throat, long stroke, and narrow table ensure plenty of free space to accommodate complex bending sequences

### Crowning

- All machines include a manual crowning system inside the table; a motorized crowning version is available as an option

### Hydraulics

- Cylinder bodies are forged from solid SAE 1040 material
- Perfectly matched hydraulic components and measuring systems ensure exact synchronization of work cylinders

### Back Gauge

- Linear guides and large preloaded ball screws are mounted in a protective enclosure to ensure smooth operation even under the most difficult environmental conditions
- Exact adjustment of back gauge finger height

### Front Support Arms

- Rigid linear guide and ball bearings for boom ensure maximum stability and easy positioning

### Bending Tools

- Promecam (European) tool mounts accommodate an extensive selection of bending tools
- All tools are hardened and ground, and allow precise setup
- Manual quick-action clamping system for tool mount shortens tool changing times

## Standard Equipment

Delem 53 T 2D control, X-axis back gauge with servo motor, manual lower table crowning, quick-action clamping of male die, manual akas laser safety LC II M FMSC safety system, light barrier, european type male die H = 67 mm, 2 front support arms moving on linear guides, foot pedal with e-stop switch, european type Bottom Tool 4V H: 60x60 mm, 2 hight adjustable back-gauge fingers, European tool clamping system, operator instructions

## Safety and Productivity

- Safety features are based on the latest CE regulations
- **Quick-action clamping male die (only on models with up to 320t force)**

## Options

To see the available options for this machine, visit our website.

Specifications	AHK H CNC	15060	20080	26100	30100	30135	30175	30220	30270
<b>Working area</b>									
Pressure force	t	60	80	100	100	135	175	220	270
Brake length	mm	1.500	2.100	2.600	3.100	3.100	3.100	3.100	3.100
Distance between columns	mm	1.300	1.700	2.200	2.600	2.600	2.600	2.600	2.600
Throat	mm	410	410	410	410	410	410	410	410
Stroke	mm	265	265	265	265	265	265	265	265
Clear opening	mm	485	485	485	485	485	485	485	485
Table width	mm	108	108	108	108	108	108	108	108
<b>Travels</b>									
Travel in X-axis	mm	500	500	500	700	700	700	700	700
<b>Feed</b>									
Bending speed	mm/s	9	9	10	10	9	10	10	9
Rapid feed	mm/s	150	145	130	130	120	120	140	125
Return speed	mm/s	110	115	110	110	95	120	110	95
<b>Drive capacity</b>									
Motor rating main drive	kW	7,5	7,5	11	11	15	18,5	22	22
<b>Measures and weights</b>									
Hydraulic tank volume	l	100	100	100	100	250	250	250	350
Overall dimensions (length x width x height)	m	2,4x1,75 x2,55	3,05x1,8 x2,68	3,45x1,9 x2,71	3,95x1,9 x2,76	3,95x1,95 x2,81	3,95x1,98 x2,85	4x2 x2,92	4x2 x2,95
Weight	kg	4.300	5.700	6.700	8.000	9.000	11.000	12.200	13.000
Part No.		182620	182621	182622	182624	182625	182626	182627	182636

Specifications	AHK H CNC	30320	37220	40175	40220	40270	40320	40400	60320	60400
<b>Working area</b>										
Pressure force	t	320	220	175	220	270	320	400	320	400
Brake length	mm	3.100	3.700	4.100	4.100	4.100	4.100	4.100	6.100	6.100
Distance between columns	mm	2.600	3.200	3.600	3.600	3.600	3.600	3.400	5.100	5.100
Throat	mm	510	410	410	410	410	510	510	510	510
Stroke	mm	365	265	265	265	265	365	365	365	365
Clear opening	mm	585	485	485	485	485	585	605	585	605
Table width	mm	154	108	108	108	108	154	154	154	154
<b>Travels</b>										
Travel in X-axis	mm	700	700	700	700	700	700	700	700	700
<b>Feed</b>										
Bending speed	mm/s	7	10	10	9	9	7	8	8	8,5
Rapid feed	mm/s	110	140	120	140	125	90	80	90	80
Return speed	mm/s	95	110	120	110	95	95	85	80	65
<b>Drive capacity</b>										
Motor rating main drive	kW	30	22	18,5	22	22	30	37	30	37
<b>Measures and weights</b>										
Hydraulic tank volume	l	350	250	250	250	350	350	350	350	500
Overall dimensions (length x width x height)	m	4,05x2,1 x3,12	4,55x2 x3	4,95x2 x2,95	4,95x2 x3	4,95x2 x3	5x2,25 x3,25	5x2,25 x3,45	7x2,25 x3,55	7,05x2,25 x3,71
Weight	kg	14.000	13.900	13.000	15.000	17.500	20.500	24.700	28.000	35.000
Part No.		182628	182629	182630	182631	182637	182632	182633	182634	182635



See this machine  
in action on  
YouTube



## Machine Frame and Male Die

- The machine frame is made of a high-precision, stress-relieved steel weldment and features a rigid bending bar and hydraulic cylinders on both sides
- A large throat and narrow table ensure plenty of free space to accommodate complex bending sequences

## Hydraulics

- The hydraulic unit with reservoir is placed in the top part of the machine frame to save space and add to the rigidity of the construction
- Precise upper beam positioning is ensured by a torsion shaft that connects the depth stops of both cylinders

## Front Support Arms

- Each support arm can be adjusted in height and is extremely sturdy
- A stop ridge on the supporting surface helps with workpiece alignment

## Bending Tools

- Promecam tool mounts to accommodate an extensive selection of bending tools
- Manual quick-action clamping system for tool mount shortens tool changing times
- With 4 bending dies the die can handle a wide spectrum of workpieces

## Safety and Productivity

- Safety features are based on the latest CE regulations
- Light curtains around the work area provide reliable protection



## Back Gauge

- The excellent stability of the NC-controlled back gauge is an important factor for achieving excellent machining precision
- Linear guides and large preloaded ball screws are low maintenance and extremely sturdy
- The motorized R-axis simplifies the precise stop-height set-up
- Lateral positioning of back gauge fingers on dual, smooth-running linear guides

## Standard Equipment

Weintek 7" NC-control, motorized backgauge X-axis, motorized backgauge R-axis, Upper tool H European style H = 67 mm (segmented), european type bottom tool 4V, sliding front support arms (2 pcs), light curtain, foot pedal with e-stop switch, operator instructions

## Options

Options	Part No.
• motorized crowning for AHK M NC	253726
• extended backgauge for X-axis (1540 NC / 2160 NC)	253659
• additional backgauge finger (pc) (1540 NC / 2160 NC)	253660

## Control

- All functions are input and retrieved directly at the touchscreen
- In manual mode, all axes can be positioned via motorized motion and the set values are shown on the display
- In semi-automatic mode, the values entered by the user are directly selected
- In auto. mode, the programmed bending sequence is positioned automatically
- Each storage area holds 500 data sets, and programs can be stored externally and re-imported
- The axis position is maintained when the display is turned off
- In addition to a USB port, the machine also features a network port at the control panel

## Specifications AHK M

		1230 NC	1540 NC	2160 NC
<b>Working area</b>				
Pressure force	t	30	40	60
Brake length	mm	1.250	1.550	2.100
Distance between columns	mm	1.010	1.260	1.700
Throat	mm	255	320	320
Stroke	mm	150	160	160
<b>Travels</b>				
Travel in X-axis	mm	500	600	600
<b>Feed</b>				
Bending speed	mm/s	10	10	10
Rapid feed	mm/s	70	90	90
<b>Drive capacity</b>				
Motor rating main drive	kW	3	5,5	7,5
Motor rating X-axis	kW	0,55	0,75	0,75
Motor rating R-axis	kW	0,25	0,25	0,25
<b>Measures and weights</b>				
Overall dimensions (length x width x height)	m	1,76x1,38x2,14	1,7x1,6x2,23	2,35x1,6x2,23
Weight	kg	1.700	3.450	4.340
Part No.		182640	182641	182642



- rigid machine frame and powerful hydraulics ensure superior production quality, accuracy and reliability
- design and equipment allow high machining speed with short tooling time and minimum down time
- powerful drives feature, low-maintenance hydraulics
- hydraulic upper die adjustment with clamping pressure control and display at the control panel
- fine adjustment of the clamping gap to avoid damages to the workpiece surface
- lower beam with manual adjustment and crowning
- manually adjustable rear stop (600 mm), and angular positioning control M15S with LED-Display are standard equipment
- bending angles up to 135°
- segmented upper die with segment divisions of 76 mm (7 each), 102 mm (3 each), 127 mm (7 each) and 152 mm (2 each) (HBM 2045)
- flexible operation with mobile triple foot switch

### Standard Equipment

position controller M15S, manual rear stop, segmented upper die 76 - 152 mm, mobile foot switch, operating tools, operator manual



Adjustable upper die clamping pressure



Rear view of the machine - manual rear stop



Standard upper die with segmentations of 76, 102, 127 and 152 mm



Exact folding angle adjustment via positioning control (standard)

## Specifications HBM

		2045	2065	2545	2565	3145	3165
<b>Working area</b>							
Working length	mm	2.035	2.035	2.540	2.540	3.100	3.100
Bending capacity, structural steel	mm	4,5	6,5	4,5	6,5	4,5	6,5
Bending capacity, stainless steel	mm	3	4,5	3	4,5	3	4,5
Bending bar angle (range)		0-135°	0-135°	0-135°	0-135°	0-135°	0-135°
Top beam travel	mm	100	100	100	100	100	100
Adj. lower bending beam	mm	25	25	25	25	25	25
<b>Drive capacity</b>							
Motor rating main drive	kW	5,5	7,5	5,5	7,5	5,5	7,5
<b>Measures and weights</b>							
Hydraulic tank volume	l	90	90	90	90	90	90
Overall dimensions (length x width x height)	m	3,3x1,55 x1,9	3,3x1,55 x1,9	3,9x1,7 x1,9	3,9x1,75 x2,05	4,5x1,75 x1,95	4,5x1,75 x2,05
Weight	kg	3.200	4.328	5.100	6.200	5.500	7.100
Part No.		131402	131404	131408	131410	131414	131416



SBS E 2540/1,5 is shown



See this machine  
in action on  
YouTube 

- The series has a rugged, very robust design and is impressively easy to handle while delivering maximum accuracy.
- All models of this series have a hardened, segmented male die.
- Segments can be removed individually, so all sides of the basin can be bent
- Adjustable angular stop for the production of angular small batches
- A manually adjustable rear gauge is available as an option

## Options

For additional options for this machine, visit our website and search for SBS E (Product Search)



Exact bending angle across the entire work length

## Specifications SBS E

		2020/2,0	2540/1,5	3020/1,2
<b>Working area</b>				
Working length	mm	2.020	2.540	3.020
Plate thickness (max.)	mm	2	1,5	1,2
Working height	mm	920	920	920
<b>Male Die</b>				
Stroke	mm	120	120	120
<b>Bending Die</b>				
Bending angle (max.)	deg	135	135	135
Adjustment range for A axis	mm	15	15	15
<b>Measures and weights</b>				
Overall dimensions (length x width x height)	m	2,8x0,85x1,3	3,32x0,72x1,5	3,8x0,72x1,5
Weight	kg	1.025	1.250	1.385
Part No.		131367	131371	131372



## Motorized 3-roller roll bending machine

### KRM-A

Motorized drive with foot pedal control and safety switch



KRM-A 20/1.5 is shown

- asymmetrical 3-Roll Bending Machine
- hardened rollers, suitable for stainless steel
- adjustable bottom and rear roller
- standard series wire core groove
- top roller swings out with eccentric closure
- foot switch
- manual feed or rear roller
- brake motor
- supplied with conical bending feature

#### Specifications KRM-A

		10/3.0	12/2.5	15/2.2	20/1.5
<b>Working area</b>					
Working length	mm	1.050	1.250	1.550	2.050
Plate thickness (max.)	mm	3,3	3	2,5	2
Max. plate thickness for bending	mm	3	2,5	2,2	1,8
Bending diameter (min.)	mm	130	130	130	135
Roll diameter	mm	90	90	90	95
Roller speed	m/min	6	6	6	6
<b>Drive capacity</b>					
Motor rating main drive	kW	1,1	1,1	1,1	1,1
<b>Measures and weights</b>					
Overall dimensions (length x width x height)	m	2,1x0,8x1,13	2,35x0,8x1,13	2,6x0,8x1,13	3,03x0,8x1,13
Weight	kg	500	570	570	635
Part No.		131881	131882	131883	131884

## Manual roll bender

### KR

Rigid cast-iron construction with manually driven rollers



KR 10/3.0 is shown

- hardened rollers, suitable for stainless steel
- top roller swings out
- easy adjustment of rear and bottom roller via hand wheel
- Bottom and rear roller with wire insertion groove
- back gear
- supplied with conical bending feature

#### Specifications KR

		10/1.0	10/1.5	10/3.0	12/1.5	15/2.0	20/1.5
<b>Working area</b>							
Working length	mm	1.050	1.050	1.050	1.250	1.550	2.050
Plate thickness (max.)	mm	1	1,5	3	1,5	2,2	1,8
Roll diameter	mm	56	70	90	75	90	95
<b>Measures and weights</b>							
Overall dimensions (length x width x height)	m	1,3x0,7x1,1	1,3x0,7x1,1	2,1x0,8x1,13	2x0,8x1,12	2,6x0,8x1,1	3,03x0,8x1,13
Weight	kg	240	320	500	510	570	635
Part No.		131885	131886	131887	131888	131889	131890



See this machine  
in action on  
YouTube



KRM 10/4.0 shown including optional equipment (motorized rear roll adjustment)

- hardened rollers, suitable for stainless steel
- motor driven left/right direction, operated with foot switch
- hand wheel for rear roll feed
- quick adjusting rolls (motor-driven, option)
- standard series wire core groove
- top roll swings out across cam lock
- supplied with conical bending feature

### Standard Equipment

hardened rollers, conical bending feature

### Options

### Part No.

• Motorized Rear Roll Adjustment for KRM (131967)	133965
• digital display KRM (131962/131963/131964/131966)	133967

### Specifications KRM

		10/4,0	10/5,0	12/3,5	12/4,0	12/5,0	15/3,0	15/4,0	20/3,0	20/4,0
<b>Working area</b>										
Working length	mm	1.050	1.050	1.250	1.250	1.250	1.550	1.550	2.050	2.050
Plate thickness (max.)	mm	5	5,5	4	4,5	5,5	3,5	4,5	4	4,5
Max. plate thickness for bending	mm	4	5	3,5	4	5	3	4	3	4
Bending diameter (min.)	mm	150	190	150	175	210	150	190	190	210
Roll diameter	mm	110	130	110	120	140	110	130	130	140
<b>Drive capacity</b>										
Motor rating main drive	kW	2,2	2,2	2,2	2,2	2,2	2,2	2,2	2,2	2,2
<b>Measures and weights</b>										
Overall dimensions (length x width x height)	m	1,82x0,85 x1,15	1,82x0,9 x1,2	2,32x0,85 x1,15	2,02x0,85 x1,15	2,02x0,9 x1,2	2,62x0,85 x1,15	2,32x0,9 x1,2	3,3x0,9 x1,2	3,24x0,9 x1,2
Weight	kg	1.080	1.220	1.150	1.250	1.365	1.220	1.360	1.480	1.530
Part No.		131960	131961	131962	131963	131964	131965	131966	131967	131968



Upper roller can be swiveled out

- Hardened rollers, suitable for stainless steel
- Taper bending fixture
- Motorized rear roller adjustment
- Rigid steel construction
- High quality steel rollers
- 2 driven rolls
- Top roller swings out
- Lower roll with manual feed, motorized feed available as an option
- Optionally available with extended roll ends for profile bending rolls

## Options

## Part No.

• extended roll shafts	253701
• section bending rolls	253706
• digital readout for backroll	253707

## Standard Equipment

hardened rollers, conical bending feature, back roll with motor, automatic central lubrication, operator manual

## Specifications KRM ST

		15/8	20/6	20/7	25/5	25/6	30/4	30/5
Working length	mm	1.550	2.050	2.050	2.550	2.550	3.050	3.050
Plate thickness (max.)	mm	8	6	7	5	6	4	5
Max. plate thickness for bending	mm	7	5	6	4	5	3	4
Bending diameter (min.)	mm	255	255	285	270	285	285	300
Roll diameter	mm	170	170	190	180	190	190	200
Motor rating main drive	kW	4	4	4	4	4	4	4
Overall dimensions (length x width x height)	m	3,35x0,72 x1,05	3,85x0,72 x1,05	4,2x0,95 x1,3	4,35x0,95 x1,3	4,7x0,95 x1,3	5,2x0,95 x1,3	5,2x0,95 x1,3
Weight	kg	1.850	2.100	3.100	3.050	3.400	3.750	4.000
Part No.		130780	130781	130782	130783	130784	130785	130786



RBM 25/20 is shown

<b>Specifications RBM</b>		<b>20/06</b>	<b>20/20</b>	<b>25/08</b>	<b>25/16</b>	<b>25/25</b>
<b>Working area</b>						
Working length	mm	2.100	2.100	2.600	2.600	2.600
Plate thickness (max.)	mm	6	20	8	16	25
Max. plate thickness for bending	mm	4	16	6	13	20
Upper roll diameter	mm	160	300	210	300	360
Lower roll diameter	mm	140	270	190	270	330
Side roll diameter	mm	120	210	170	210	250
<b>Drive capacity</b>						
Motor rating hydraulic pump	kW	2,2	15	7,5	11	18,5
<b>Measures and weights</b>						
Overall dimensions (length x width x height)	m	4,14x1,14 x1,04	4,53x1,73 x1,49	4,64x1,39 x1,3	5,03x1,73 x1,49	5,04x1,9 x1,68
Weight	kg	2.320	7.000	4.600	8.110	11.800
Part No.		131900	131903	131906	131909	131912

**For more 4-roller roll bending machines with NC teach-in, visit our website**



- massive machine frame, based on an advanced design and many years of experience
- hydraulic safety chuck for easy removal of the part
- roller adjustments (feed and adjustment of parallelism and taper) at the control panel
- all rollers are hardened and equipped with precision bearings
- hydraulically driven top and bottom rollers
- hydraulic components from Parker / Bosch
- electric components from Siemens / Telemanique
- minimum bending diameter =  
5 times the diameter of the top roller (RBM 30/70)  
3 times the diameter of the top roller (except RBM 30/70)

### Standard Equipment

hardened rollers, conical bending feature, digital display, control panel, operator manual

Options	Part No.
• Material Feed Table	133934
• Side Support	133935
• Center Support	133936
• Infinitely Variable Rotation Speed	133903

For additional options for this machine, visit our website.

Specifications RBM		25/45	30/13	30/20	30/50	40/08	40/16
<b>Working area</b>							
Working length	mm	2.600	3.100	3.100	3.100	4.100	4.100
Plate thickness (max.)	mm	45	13	20	50	8	16
Max. plate thickness for bending	mm	35	10	16	40	6	13
Upper roll diameter	mm	460	300	360	540	300	390
Under roll diameter	mm	420	270	330	510	270	360
Side roll diameter	mm	360	210	250	440	210	300
<b>Drive capacity</b>							
Motor rating hydraulic pump	kW	30	11	15	55	7,5	15
<b>Measures and weights</b>							
Overall dimensions (length x width x height)	m	5,97x2,3 x2,59	5,53x1,73 x1,49	5,54x1,9 x1,68	6,67x3 x2,93	6,53x1,73 x1,49	7,24x2,1 x1,98
Weight	kg	30.000	8.800	13.200	40.000	9.930	20.800
Part No.		131915	131921	131924	131927	131933	131936

















KPB 50 shown



KPB 30 shown

- millimeter scale for roller adjustment
- ground drive shafts with double support provided by cone bearings at both ends
- one-piece gliding central block mounted on hardened crosshead
- mechanical feed, 2 driving rollers, horizontal and vertical applications

Example	KPB 30			KPB 50		
Profiles	Dimens.	Bending Ø*	Rollers	Dimens.	Bending Ø*	Rollers
	50x10	800	A	60x10/50x12	800	A
	80x15	700	A	120x15	750	A
	30x30	700	A	35x35/20x20	1200/400	A
	Ø 30	700	B	Ø 35	800	B
	40x5	400	A	50x5	850	A
	40x5	500	A	50x5	1200	A
	50x6	800	A	50	650	A
	50	850	A	50	900	A
	UNP50	400	B	UNP60	550	A
	UNP50	500	B	UNP60	700	A
	1 1/2"	900	B	33,7x2,65	320	B
	Ø 60x2	1200	B	Ø 70x2	1200	B
	40x40x3		B	60x60x3		B
	50x30x3		B	50x40x3		B

\* min. Bending Ø

**A** Standard Rollers  
**B** Special Rollers

## Standard Equipment

standard rollers, foot pedal, control panel, operating tools, operator instructions

Specifications	KPB	30	50
<b>Working area</b>			
Shaft Ø	mm	30 / 35	50
Roll Ø	mm	132 / 137	155
Bending speed	m/min	2,1	4,3
<b>Drive capacity</b>			
Motor rating main drive	kW	0,75	1,5
<b>Measures and weights</b>			
Weight	kg	185	400
Length	mm	670	730
Width	mm	530	830
Height including base	mm	1.350	1.350
Part No.		130158	131151

## KPB 45

- incl. a modular roller system for optimum adaptation to desired profile
- manually adjustable leveling rolls
- hardened and ground shafts
- allows horizontal or vertical machining
- hydraulic components made by leading manufactures
- hydraulic movement of upper roll
- separate control panel

### Standard Equipment for KPB 45:

- Control panel, standard rollers, operating tools, operator manual



KPB 45 shown

## KPB 61, 81, 101

- optimum adaptation to a large variety of profiles using the modular roller system
- 3 hydraulic-driven rollers
- hardened and ground shafts
- overload slip-clutch
- hydraulic feed of bottom rollers with digital display
- hydraulically adjustable straightening rollers; optional
- allows horizontal or vertical machining
- hydraulic components made by leading manufactures

### Standard Equipment for KPB 61, 81, 101:

- Digital display, control panel, standard rollers, operating tools, operator manual



KPB 61 shown

KPB 81 shown incl. optional accessories hydraulically controlled straightening rollers

## Specifications

		KPB 45	KPB 61	KPB 81	KPB 101
<b>Working area</b>					
Shaft Ø	mm	50 / 40	60	80	100
Roll Ø	mm	152 / 162	177	245	315
Bending speed	m/min	3,3	6,4	4,2	5,4
Driven roll	Pieces	3	3	3	3
<b>Drive capacity</b>					
Motor rating hydraulic pump	kW	1,5	4	5,5	11
Supply voltage	V	400	400	400	400
<b>Measures and weights</b>					
Overall dimensions (length x width x height)	m	0,78x0,95x1,65	1,26x0,94x1,39	1,38x1,04x1,54	1,44x1,22x1,68
Weight	kg	500	1.080	1.600	3.500
Part No.		131150	131194	131200	131206

# Presses

**See for yourself live:** Many models are in stock or can be viewed and tried out at a user's location near you. Make a demonstration appointment! [info@knuth.com](mailto:info@knuth.com)



## Experience our machines in action!

With our YouTube channel KNUTH Machine Tools, you stay up to date with all the news and developments.



Hydraulic C-frame press

### HPK A

Pressure capacity **40 - 300 t**  
Stroke **500 mm**

Large slide plates and working tables  
for large tools

Page 274 / 275





H-frame hydraulic press

## KP A

Pressure capacity **40 - 400 t**

Piston stroke **500 mm**

For bending and punching

Page 272 / 273

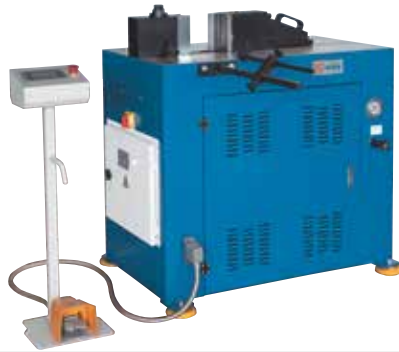

Hydraulic straightening and compression press

## KHP

Pressure capacity **28 - 40 t**

Piston stroke **180 - 250 mm**

Bending and straightening - strong and compact

from page 280 onwards

Portal hydraulic press

## PWP

Pressure capacity **100 - 150 t**

Piston stroke **380 - 400 mm**

Presses with a press that can be positioned manually

Page 276 / 277



Motorized workshop press

## KNWP

Pressure capacity **15 - 200 t**

Piston stroke **160 - 400 mm**

Motorized and manual presses for every workshop

from page 278 onwards





- **Siemens PLC**
- **2-hand operation**
- **Automatic operation**

- **Made in Europe** - perfectly welded frame steel construction for high rigidity, designed for maximum machine force
- Hydraulic presses are extremely versatile due to their distance/time flexibility of the stroke
- A large hydraulic cylinder moves the thick ram plate, stabilized by heavy-duty self-lubricating circular guides
- Work table and ram plate feature T-slots for tool clamping
- A mobile control panel provides flexibility, while additional controls are easily accessible integrated in the control cabinet



Shown with large capacity of 900 - 1500 mm



Work example is shown

- The hydraulic system is designed as stand-alone unit for low maintenance and optimum thermal balance
- 2-step hydraulic pump for fast rapid feeds and optimum stroke speeds
- Precision-machined cylinder surfaces and high-quality seals ensure low wear and long lasting reliability
- All components are made according to strict standards, and the entire construction meets European safety guidelines

### Standard Equipment

two-hand control panel, adjustable stops for up/downstroke, pressure gauge, movable upper table with 2 guides and T-slots, Automatikbetrieb, automatic cylinder return, Siemens PLC, hydraulic unit with 2 speed automatic change, pressure switch, work hours timer, operator manual

### Options

### Part No.

• upgrade from 2 to 4 lateral slides	253857
• upgrade from 2 to 4 lateral slides	253858
• Light curtain L = 1,000 mm	253855
• upgrade to Siemens KTP 700 Basic digital control	253856
• Predisposition "industry 4.0"	253859
• pieces counter	253860
• Air/oil heat exchanger with decompression valve	253861
• decompression valve	253862

### Specifications KP

		40 A	70 A	100 A	150 A	200 A	300 A	400 A
<b>Working area</b>								
Pressure force	t	40	70	100	150	200	300	400
Table dimensions	mm	800x500	800x500	900x600	1.200x700	1.200x700	1.400x1.000	1.400x1.000
Stroke	mm	500	500	500	500	500	500	500
Ram-plate size	mm	700x350	700x350	700x350	1.000x400	1.000x400	1.100x800	1.200x900
Throat width	mm	900	900	1.050	1.250	1.250	1.500	1.500
Stroke speed	mm/s	9	5	4	3	2	2	2
<b>Rapid feed</b>								
Rapid feed	mm/s	26	25	26	22	20	22	20
<b>Drive capacity</b>								
Motor rating	kW	4	4	4	4	5,5	7,5	7,5
<b>Measures and weights</b>								
Overall dimensions (length x width x height)	m	1,6x0,7 x2,2	1,85x1,04 x2,25	2,08x1,05 x2,26	2,35x1,5 x2,5	2,35x1,6 x2,5	2,5x1,65 x2,65	2,5x1,7 x2,8
Weight	kg	1.050	1.450	2.300	4.900	5.800	7.200	8.500
Part No.		131500	131501	131502	131503	131504	131505	131506



Diagonally aligned slots for easy centered tool clamping

- **Siemens PLC**
- **2-hand operation**
- **Automatic operation**

- **Made in Europe** - perfectly welded C-frame steel construction for high rigidity, designed for maximum machine force
- Large ram plates and work tables to ensure large tools or multiple setups
- Hydraulic press brakes are extremely versatile due to their distance/time flexibility of the stroke
- A powerful hydraulic cylinder and two self-lubricating circular guides ensure precise and uniform feed of the ram plate during press operations
- Precision-machined cylinder surfaces and high-quality seals ensure low wear and long lasting reliability



Two circular guides ensure maximum ram plate parallelism during stroke movement

Space saving hydraulic system located accessibly inside the frame

- Rapid adjustment of stroke length via easy to set stops
- 2-step hydraulic pump for fast rapid feeds and optimum stroke speeds
- Ram plate and work table with t-slots for tool clamping
- A mobile control panel provides flexibility, while additional controls are easily accessible integrated in the control cabinet
- All components are made according to strict standards, and the entire construction meets European safety guidelines

### Options

### Part No.

• upgrade from 2 to 4 lateral slides	253858
• Light curtain L = 1,000 mm	253855
• upgrade to Siemens KTP 700 Basic digital control	253856
• upgrade from 2 to 4 lateral slides	253857
• Predisposition "industry 4.0"	253859
• pieces counter	253860
• Air/oil heat exchanger with decompression valve	253861
• decompression valve	253862

### Standard Equipment

two-hand control panel, adjustable stops for up/downstroke, pressure gauge, movable upper table with 2 guides and T-slots, Automatikbetrieb, automatic cylinder return, Siemens PLC, hydraulic unit with 2 speed automatic change, pressure switch, work hours timer, operator manual

### Specifications HPK

		40 A	70 A	100 A	150 A	200 A	300 A
<b>Working area</b>							
Pressure force	t	40	70	100	150	200	300
Table dimensions	mm	700x500	700x500	800x600	900x600	1.000x600	1.200x800
Stroke	mm	500	500	500	500	500	500
Ram-plate size	mm	700x350	700x350	700x350	800x400	870x500	1.000x500
Throat	mm	250	250	300	300	300	400
Stroke speed	mm/s	9	5	4	3	3	2
<b>Rapid feed</b>							
Rapid feed	mm/s	26	24	25	20	21	22
<b>Drive capacity</b>							
Motor rating	kW	4	4	4	4	7,5	7,5
<b>Measures and weights</b>							
Overall dimensions (length x width x height)	m	1,5x1x2,5	1,5x1x2,5	1,9x1,2x2,6	2,2x1,5x3	2,3x1,5x3	2,3x1,5x3,1
Weight	kg	1.500	2.100	3.400	5.500	8.200	11.200
Part No.		131507	131508	131509	131510	131511	131512



- This press with its manually movable gantry is manufactured exclusively in Europe and made of high-grade quality steel
- The large setup table makes it perfect for straightening large sheet metal plates and structures
- This machine is perfectly suited for performing stress tests, welding sample testing, and material testing
- Repairs, assembly work, straightening of axes, beams, shafts as well as press-fitting or removing bearings and bushings can easily be performed on this machine
- With a manually movable gantry and a laterally positioned cylinder, the entire table surface can be utilized for machining.
- The hydraulic system is powerful and reliable; the hydraulic cylinder can be moved via a motor or manually (via hand-pump)



Piston unit can be moved laterally

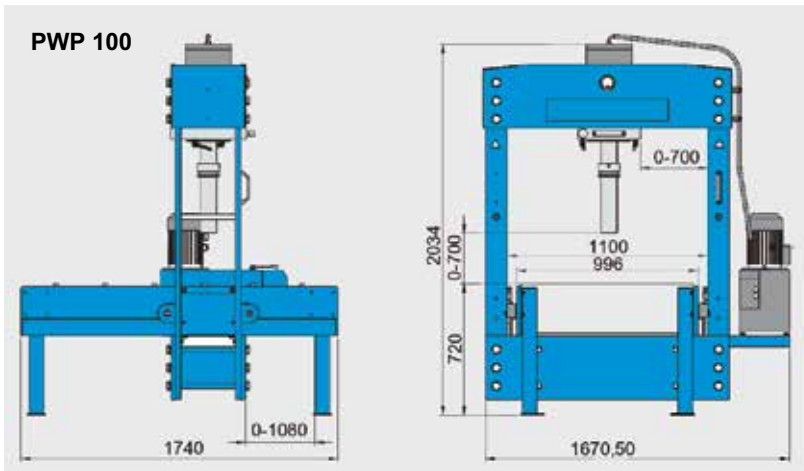

Gantry can be moved across the entire table surface

## Specifications

		PWP 100	PWP 150
<b>Working area</b>			
Gantry width	mm	1.100	1.100
Table dimensions	mm	1.740x996	1.740x996
Table height	mm	720	760
Distance piston/ table surface max.	mm	700	700
Pressure force	t	100	150
Operating pressure (max.)	bar	258	255
Stroke	mm	380	400
Forward motion speed	mm/s	7,54	7,48
Press speed	mm/s	2,47	2,4
Return speed	mm/s	9,06	9,35
<b>Drive capacity</b>			
Motor rating hydraulic pump	kW	2,2	3
<b>Measures and weights</b>			
Hydraulic tank volume	l	30	30
Overall dimensions (length x width x height)	m	1,74x1,67 x2,03	1,74x1,73 x2,1
Weight	kg	1.395	2.185
Part No.		131546	131548

- The press features an integrated pressure gauge
- The motorized hydraulic unit is operated via joystick and features 2-step hydraulics - with change-over switch for changing between quick-stroke and work stroke, shut-off during high-speed operation, and pressure regulator
- The manual pumping feature allows high-precision press operation

## Standard Equipment

operator manual, pressure gauge, hydraulic unit

## KNWP HM

Hydraulic Shop Press with double-acting cylinder

- multiple sizes available from 60 - 200 tons
- ideal for repair and assembly work
- truing of axles, supports, shafts and much more
- for removal and pressfitting bearings and bushings
- 2-step hydraulic unit
- Work cylinder with smooth horizontal adjustment

### Options

### Part No.

- |                           |        |
|---------------------------|--------|
| • V-Block for KNWP 200 HM | 251056 |
|---------------------------|--------|

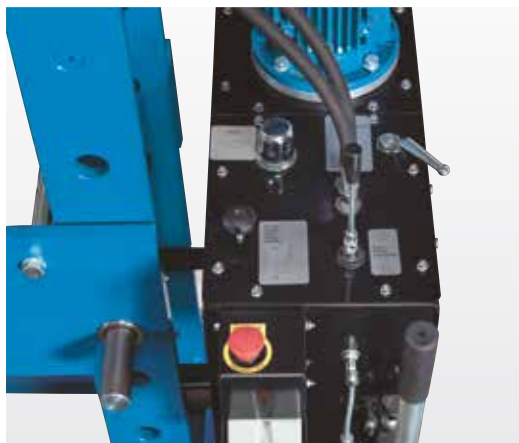

The press is operated via joystick



KNWP 100 HM is shown

### Specifications KNWP HM

		60	100 L	100	160 L	160	200
Pressure force	t	60	100	100	160	160	200
Operating pressure (max.)	bar	259	258	258	255	255	243
Stroke	mm	380	380	380	400	400	400
Forward motion speed	mm/s	8,69	7,54	7,54	7,48	7,48	5,73
Press speed	mm/s	2,07	2,47	2,47	2,4	2,4	1,84
Return speed	mm/s	10,79	9,06	9,06	9,35	9,35	7,08
Throat width	mm	750	1.500	1.100	1.500	1.100	1.300
Motor rating hydraulic pump	kW	1,5	2,2	2,2	3	3	3
Hydraulic tank volume	l	41	46	46	57	57	64
Weight	kg	540	1.145	970	1.430	1.195	1.690
Part No.		131744	131765	131745	131766	131746	131747





V-shaped support set



Foot control (KNWP 30 / 50 M) only



KNWP 30 M is shown

### For any repair and installation work, e.g.:

- removal and installation of press-fit bearings, bolts and bushings
- straightening beams, shafts, axles and sections
- pressing and crimping
- load tests and weld sample testing
- straightening of workpieces
- material testing



See this machine  
in action on  
YouTube



Specifications KNWP M		15	30	50
Pressure force	t	15	30	50
Operating pressure (max.)	bar	382,2	374,6	399,5
Total piston stroke	mm	160	160	160
Throat width	mm	560	565	750
Hydraulic tank volume	l	1,65	1,65	1,65
Weight	kg	117	150	250
Overall dimensions	m	0,83x0,6	0,83x0,64	1,1x0,76
ϕ(length x width x height)		x1,93	x2,05	x2,12
Part No.		131742	131741	131743

- rigid machine frame featuring a carefully machined weldment structure
- 2-step hydraulics - with change-over switch for changing between quick-stroke and work stroke
- hydraulic pump can be operated by hand or foot control (KNWP 30 / 50 M)
- Automatic reset of piston, controllable by user via throttle valve and spring
- the support table features a rigid design, but is easy to handle with adjustable height
- Includes multi-function die for straightening flat material and corrugation
- Table lifting system (KNWP 50 M)
- Hydraulic cylinder with side adjustments (KNWP 30/50 M)

## KHP 28 NC

Bending and straightening - powerful and compact



**Made in Europe**



Manual side stop for batch production



Angle lines are engraved in the work table for easy orientation

- The horizontal bending and straightening press features a stamp and a 4-channel die for machining up to 200 mm wide material
- The hydraulic system can be regulated via pressure and flow valves, allowing the user to control the pressing force and work speed according to requirements
- Practically arranged control panel, and easy to read LED display showing the work cylinder positions
- The operator can choose between manual or automatic control, and up to 4 different programs can be stored

### Specifications

		<b>KHP 28 NC</b>
Pressure force	t	28
Hydraulic pressure max.	bar	200
Y-axis stroke	mm	180
Piston diam.	mm	130
Motor rating main drive	kW	4
Overall dimensions (length x width x height)	m	1,15x0,75x1,1
Weight	kg	650
Part No.		131547

### Standard Equipment

stamps and dies, material stop, operator instructions



Compact hydraulic unit located accessibly inside the base



Long, supporting, hardened bending die guideways with central lubrication system

- The horizontal bending and straightening press features a powerful hydraulic drive plus a stamp and a die for machining up to 160 mm wide flat material
- The large, very rigid support table provides superior structural strength
- The large mount for the bending v-block is anchored to the table for maximum rigidity
- An adjustable side stop simplifies workpiece positioning

## Specifications

		KHP 40 NC
Pressure force	t	40
Hydraulic pressure max.	bar	260
Y-axis stroke	mm	250
Piston diam.	mm	50
Motor rating main drive	kW	1,5
Overall dimensions (length x width x height)	m	1,55x0,8x1,36
Weight	kg	680
Part No.		130611

## Standard Equipment

upper tool 60°, 160 x 88 mm, bending die, 80 mm opening width, central lubrication, Touchscreen operator panel with foot switch, side gauge 550 mm, operator instructions

## Machine accessories

3-axis position displays, turning, milling and drilling protection shields, collet chucks, collet set, pull studs, thread cutting unit, and accessory set for drilling machines

from page 286, 301 onwards



## Workshop equipment

Load steering, load rollers, vibrating elements and LED work lights

from page 284 onwards

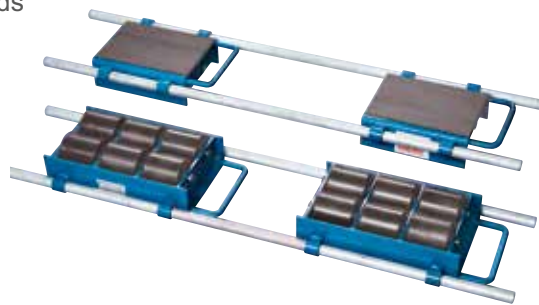

## Clamping systems and accessories

Dividing attachment, dividing head, rotary tables, cross tables, vices, lathe chuck, quick-change tool holder, clamping tool assortment, stud bolts and T-slot nuts assortment, step block assortment and lever clamps

from page 291 onwards



## Measuring equipment

Dial gauge, precision dial gauge, precision magnet measuring tripods and micrometer gauges

Page 298



Load Guidance		L 6	L 12
load capacity	t	6	12
number of rollers	pcs.	8	8
roller material		plastic	steel
dimensions	mm	630 x 400 x 115	630 x 410 x 100
intrinsic weight	kg	50	66
Part No.		140 206	140 212



Load Rollers, adjustable

## R 6 • R 12

For machine transportation, at least one load control and one adjustable load roller will be required. For example: L6 and R6 (total load capacity 12 t)

Adjustable Load Rollers		R 6	R 12
load capacity	t	6	12
number of rollers	pcs.	8	12
roller material		plastic	plastic
dimensions	mm	250 x 200 x 115	350 x 200 x 115
intrinsic weight	kg	30	38
Part No.		140 106	140 112

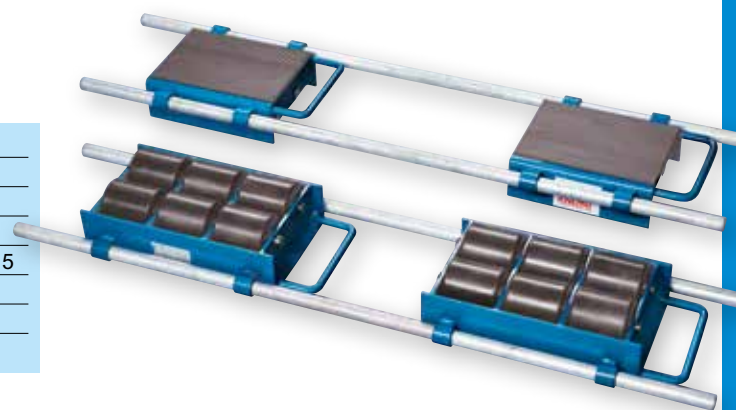

Pivoted Mounts

## LK

- damper elements absorb shock and vibration
- vibration-free machine operation
- set screws allow for easy machine alignment

	NI	D	H	L	g
LK 3	12	120	32	100	M 12
LK 5	12	160	35	120	M 16
LK 6	12	180	39	160	M 20

Specifications load capacity per element (kg)	LK 3	LK 5	LK 6
Lathes	270	380	900
Milling machines	370	500	1,600
Surface grinders	500	900	2,400
Punch press / strokes 100	420	800	2,000
Punch press / strokes 150	260	400	1,000
Punch press / strokes 200	180	200	450
Part No.	103 330	103 331	103 332

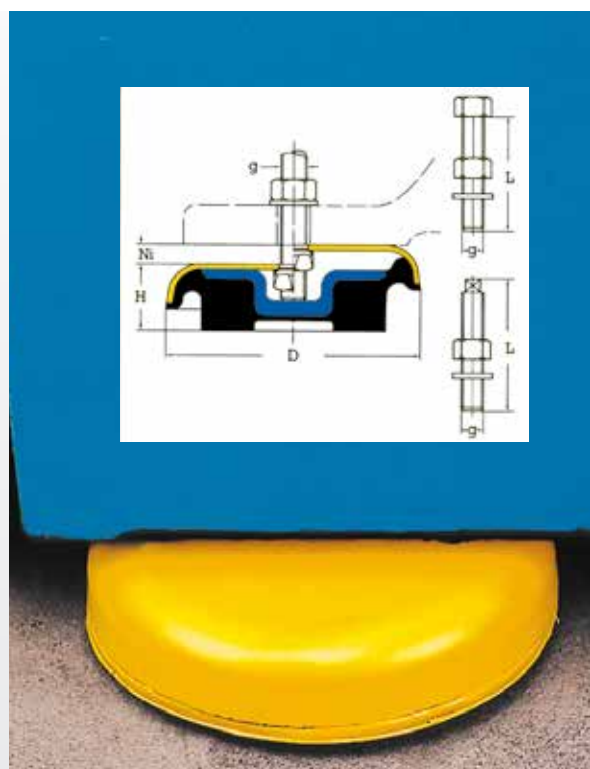
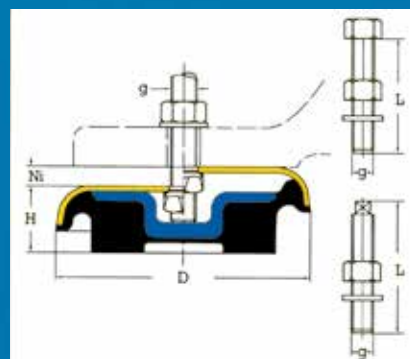

**Excellent illumination with low energy consumption and long service life**

- a true advancement in lighting technology – perfect for any production situation, where good lighting is needed
- the high-power LED module generates light with a color temperature corresponding to natural light; it is vibration and shock resistant and provides a mean service life of 50.000 hours – ideal for harsh operating conditions
- LED lights provide virtually the same light intensity as conventional halogen lights, but they save energy and cost
- the lamp enclosures are very rugged and protected against ingress of water, oil and dust (IP 65)



**LED - Strip Lights and Ring Lights**

- strong magnets on the back ensure quick mounting and reliable hold even in areas that are difficult to access, like angles and corners
- 12 / 24 Volt supply directly from the control cabinet via included mains transformer and cable

Specifications		LED rings			LED strips			
dimensions	mm	85	100	200	270	570	870	1120
Part No.		670 600	670 601	670 602	670 603	670 604	670 605	670 606



Specifications		LED flex	LED 100	LED 280	LED 400
arm length	mm	500	-	320 + 280	320 + 400
light source		HI POWER LED 3 W / 3 bulbs	HI POWER LED 1 W / 8 bulbs	HI POWER LED 1 W / 8 bulbs	HI POWER LED 1 W / 8 bulbs
service life	hours	50000	50000	50000	50000
light angle		30°	70°	70°	70°
color temperature	K	6000-7000	6000-7000	6000-7000	6000-7000
light intensity		>1100 LUX (700)	>1100 LUX (700)	>1100 LUX (700)	>1100 LUX (700)
surface temperature		<50°	<50°	<50°	<50°
voltage	V	AC/DC24	AC/DC24	AC/DC24	AC/DC24
current	mA	700	700	700	700
power	W	9	8	8	8
IP		IP 65	IP 65	IP 65	IP 65
cable length	m	1.2	1.2	1.2	1.2
Part No.		110 030	110 031	110 032	110 033

## Lathe headstock

- Incl. chrome-plated fastening rod and safety micro-switches
- Easy mounting via screws at the headstock

Inside Ø	Part No.
400 mm	103 030
500 mm	103 031
600 mm	103 032



## Lathe support

- Incl. safety micro-switch
- Rigid steel construction, swivels to both sides
- Polycarbonate viewing window

Dimensions (HXW)	Part No.
1500 x 150 mm	103 033
1500 x 200 mm	103 034



## Lead screw and feed shaft guards

- Resistant against oil, heat and acid, meets safety class M2
- High-strength aramide belt with strong polyurethane connection for high loads
- Individually mountable at machine

Dimensions (LxH)	Part No.
1500 x 150 mm	103 035
1500 x 200 mm	103 036
2000 x 200 mm	103 037
3000 x 250 mm	103 038



## Drill Press Quill

- Incl. safety micro-switch
- Adjustable to boring depth
- Polycarbonate viewing window

Model	Part No.
BP 1	103 043
BP 2	103 044

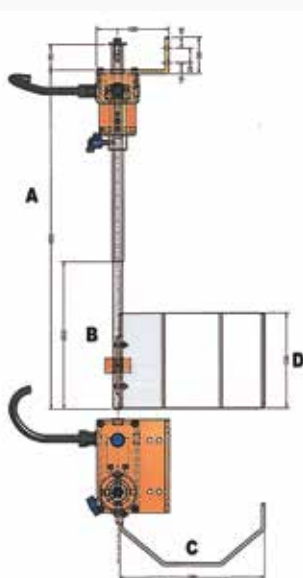

A	465 mm
B	202 mm
C	200 (BP 1) / 300 mm (BP 2)
D	130 (BP 1) / 200 mm (BP 2)



## Milling machine - cutter spindle

- Strong construction with robust connectors
- Individually adjustable arms
- Easy mounting via screws
- 2 electric safety switches
- Can be mounted left or right

Disk diameter	Part No. right side	Part No. left side
400 mm	103 039	103 041
500 mm	103 040	103 042



III.  
Part no. 108 770

- 5 turning tools for steel working
- 5 forms (left, right, centered)

III.  
Part no. 108 680

III. Part no. 108 670

**Clamped Turning Tool Set:** Part no. 108 670  
P25 indexable insert for forged, rolled and tempered steel. All tools with indexable inserts, 1 indexable insert set (s.above), tools, specifications, shank height 25 mm

**Indexable insert set:** 30 pc. Part no. 108 675

**Clamped turning tool set:** Part no. 108 778  
shank height 20 and 25 mm, shanks 20 mm, 9 tools

**Indexable insert set:** 30 pc. Part no. 108 779

**Clamped turning tool set:** Part no. 108 780  
5 tools cutting height 16 mm, shanks 20 mm  
3 tools cutting height 20 mm, shanks 20 mm  
1 tool cutting height 24 mm, shanks 20 mm

**Indexable insert set:** 30 pc. Part no. 108 782

## Clamped Turning Tool Set

Shank	Part No.	5 replacem.
10 mm	108 770	108 774
12 mm	108 771	108 775
16 mm	108 772	108 775
20 mm	108 773	108 775

## Turning Tool Set

with soldered-on carbide plates for steel, 8 pieces

shank 12 mm, Part no. 108 680

shank 16 mm, Part no. 108 690

shank 20 mm, Part no. 108 700

## Knurl Holder

• shank H20, B14, total 140 mm

• incl. 2 knurl sets, angled 1 mm

Part no. 108 520

## knurl set, angles

Part no. 108 521



## Clamped Turning Tool Set

Includes 8 different clamped turning tools, listed in the sequence shown (Part no. 108 670):

### 1. necking turning tool, clamping system C, workpiece Ø 60 mm

size	cutting point height	V	f	a
25x25x140 mm	-	100 m/min.	0,4-0,5 mm	4 mm

### 2. tapping turning tool 60°, clamping system C

size	cutting point height	V	f	a
18x18x180 mm	25 mm	-	-	-

### 3. stepped, right-hand turning tool, plate form S, clamping system M, cutting length 16 mm, incl. chip chute

size	cutting point height	V	f	a
25x20x125 mm	-	80 m/min.	0,6-0,7 mm	6 mm

### 4. curved, right-hand turning tool, plate form S, clamping system M, cutting length 16 mm, incl. chip chute

size	cutting point height	V	f	a
25x20x125 mm	-	80 m/min.	0,4-0,5 mm	4 mm

### 5. stepped, right-hand inside turning tool, clamping system C

size	cutting point height	V	f	a
18x18x180 mm	14 mm	60 m/min.	0,2 mm	4 mm

### 6. curved, right-hand turning tool, plate form S, clamping system C, cutting length 16 mm, incl. chip chute

size	cutting point height	V	f	a
18x18x180 mm	14 mm	60 m/min.	0,2 mm	4 mm

### 7. stepped, right-hand turning tool, plate form S, clamping system M, cutting length 20 mm, incl. chip chute

size	cutting point height	V	f	a
20x20x125 mm	-	100 m/min.	0,4-0,5 mm	4 mm

### 8. female thread turning tool, clamping system C

size	cutting point height	V	f	a
18x18x180 mm	25 mm	-	-	-

## Collet Chuck MAS-BT

Model	D	D1	L1	Part No.
BT30-ER25	42	31,75	70	104 200
BT30-ER32	50	31,75	70	104 201
BT40-ER32	50	44,45	100	104 202
BT40-ER40	63	44,45	80	104 206
BT50-ER32	50	69,85	100	104 204
BT50-ER40	63	69,85	100	104 205



### ER Collet Set

DIN 6499

Form B

		Part No.
ER 25, 16-pieces	1 - 16 mm	106 050
ER 32, 6-pieces	6, 8, 10, 12, 16, 20 mm	106 052
ER 40, 15-pieces	3, 4, 5, 6, 8, 10, 12, 14, 15, 16, 18, 20, 22, 24, 25 mm	106 075

For other chucks for MT 3 / MT 4, visit [www.knuth.com](http://www.knuth.com)



### ER Collet Chucks

ER 32				
Mount	MT 3	MT 4	ISO 30	ISO 40
Part No.	106 057	106 058	106 055	106 056
ER 40				
Part No.	106 063	106 064	106 061	106 062

### Draw Bolts DIN 69872

Model	Part No.	
	A	B
SK 30 (A) (B)	103 600	103 604
SK 40 (A) (B)	103 601	103 605
SK 50 (A) (B)	103 603	103 607





- integrated quick-return acts promptly upon feed direction change
- slip coupling torque adjustable to 4 levels
- including MT 2 and MT 3 shank or MT 3 and MT 4 shank
- for thread cutter

- M 2 - M 7 (MT 2 + MT 3)  
Part No. 106 033

- M 5 - M 12 (MT 3 + MT 4)  
Part No. 106 035

- M 8 - M 20 (MT 3 + MT 4)  
Part No. 106 037

### Thread-Cutting Chuck

Compact design featuring high stability and safety features

- Wide setup range - in addition to metric, British, and US standards, it also accommodates custom sizes
- Applications: Thread cutters, drill presses, high-speed lathes, and CNC machining centers



Specifications GSF		M2-13/B16	M5-20/B18	M6-24/MK4
Diameter	mm	48	54	60
Length	mm	73	85	205
Part No.		104 710	104 712	104 713

### Accessories for Drill Presses

- includes quick-action drill chuck and bits
- packed in a wooden case



Contents / Set:	MT 2 (6-piece)	MT 3 (7-piece)	MT 4 (8-piece)	ISO 30 (4-piece)	ISO 40 (5-piece)
Reducing Sleeve	MT 2 / MT 1	MT 3 / MT 2	MT 4 / MT 3	ISO 30 / MT 2	ISO 40 / MT 2
Reducing Sleeve	-	MT 3 / MT 1	MT 4 / MT 2	ISO 30 / MT 3	ISO 40 / MT 3
Reducing Sleeve	-	-	MT 4 / MT 1	-	ISO 40 / MT 4
Extension Sleeve	MT 2 / MT 3	MT 3 / MT 4	MT 4 / MT 5	-	-
Tool-Holder Bits	MT 2 / B 16	MT 3 / B 18	MT 4 / B 18	ISO 30 / B 18	ISO 40 / B 18
Tool-Holder Bits	MT 2 / B 18	MT 3 / B 16	MT 4 / B 16	-	-
Quick-action Chuck	3 - 16 mm / B 18	3 - 16 mm / B 18	3 - 16 mm / B 18	3 - 16 mm / B 18	3 - 16 mm / B 18
Quick-action Chuck	1 - 13 mm / 16	1 - 13 mm / B 16	1 - 13 mm / B 16	-	-
Part No.	104 592	104 593	104 594	104 595	104 596

## Quick-Set Spindle Bore Stop

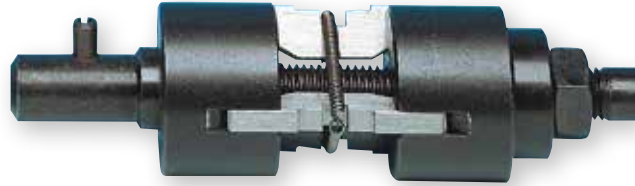
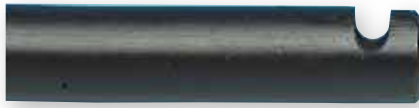

- for lathes
- quick and easy adjustment to any hollow-spindle point
- easy adjustment - just tightening with a safety wrench

Size	Range	Wrench length	Part no.
1	19-23	540	103 010
2	22-26	540	103 012
3	25-31	540	103 014
4	30-38	640	103 016
5	38-48	640	103 018
6	46-58	740	103 020
7	56-66	740	103 022
8	64-81	940	103 024
9	79-91	940	103 025
10	90-110	940	103 026
11	110-130	940	103 027



## Radius Cutting Head

Clamps into the turning tool just like a tool-holder.

- For inside and outside machining of convex and concave forms.
- For turning of 90°, 180° radius. Radius from 0 to 25 mm.
- Machining depth up to 7 mm in ST50.

Part no. 103 350

## Live centers

- Precision needle bearings
- Center is hardened and ground, 60°



Morse taper	Center Ø	Body	Length	Part No.
MT 2	22	38	125	106 745
MT 3	26	50	165	106 750
MT 4	30	59	200	106 755
MT 5	45	70	240	106 760

## ST 130 • 155

- gear ratio 1:90, disengages for direct division, manual 360° rotation of chuck
- hand wheel with scale ring
- Nonius division 10"
- 6 masks for direct division of 2, 3, 4, 6, 8, 12, 24 parts
- hardened and ground teeth with 3-jaw chuck, 160 or 200 mm



**Optional accessory set for ST 130 & ST 155:**

dividing plate A 26, 28, 30, 32, 34, 37, 38, 39, 41, 43, 44, 46, 47, 49, 51, 53, 57, 59  
 dividing plate B 61, 63, 67, 69, 71, 73, 77, 79, 81, 83, 87, 89, 91, 93, 97, 99

**Tailstock**

ST 130 Part No. 110 970  
 ST 155 Part No. 110 971

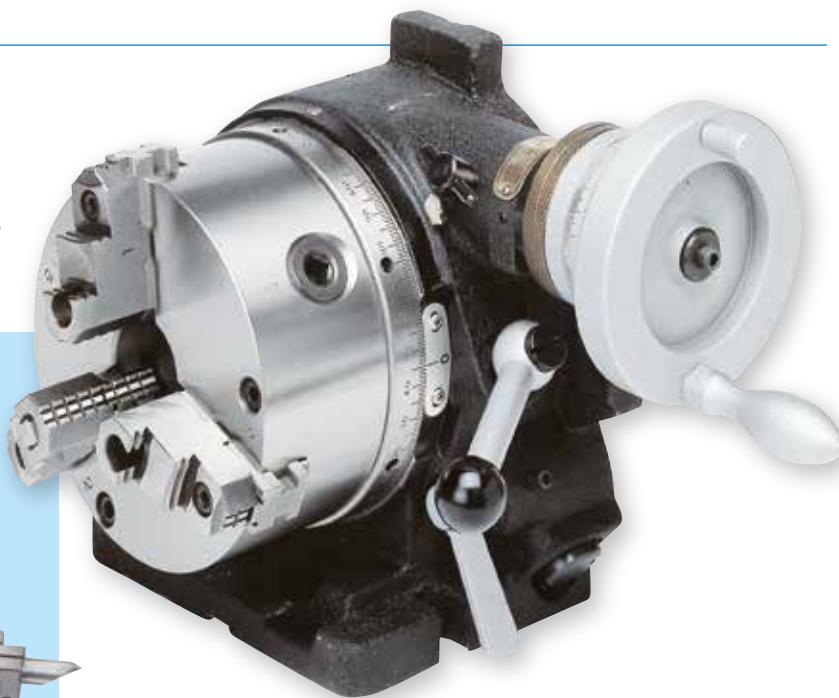

ST 130 Part No. 110 960  
 ST 155 Part No. 110 965

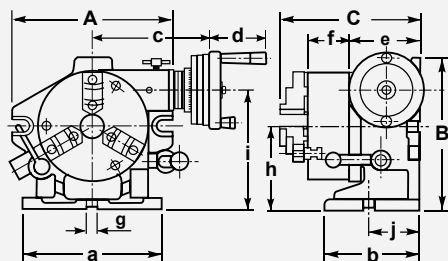

Typ	A	B	C	a	b
ST 130	250	235	221	220	150
ST 155	310	285	243	225	160
Typ	c	d	e	f	g
ST 130	184	82	112	66	16
ST 155	201	82	125	75	16
Typ	h	i	j	Weight	
ST 130	130	186	80	48 kg	
ST 155	155	232	90	76 kg	

Direct indexing head

## S 200

The **S 200 Direct Indexing Head** can be used in a **horizontal** or **vertical** setup. The indexing unit is enclosed in the resistant cast-iron body of the divider, where it is protected from contamination to ensure precise and constant divisions of 2, 3, 4, 6, 8, 12, and 24. An easy-to-read circumferentially mounted Nonius scale provides exact divisions up to 360°. A sturdy clamping lever is provided for the torsion-proof fixture of the chuck at any set position

Specifications	S 200	
Center height	mm	150
Manual 3-jaw-chuck diameter	mm	210
Divisions		2, 3, 4, 6, 8, 12, 24
Spindle concentricity radial	mm	0,01
Indexing accuracy	"	25
Weight	kg	59
Part No.		110966



**Standard Equipment**

5 indexing masks, chuck, operating tools

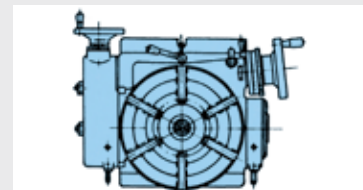
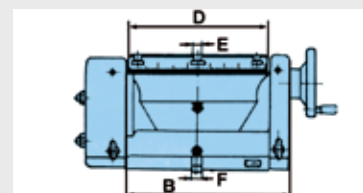
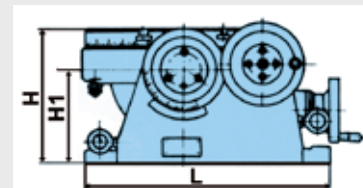

### Options

Options	Part No.
• INDEX-feature / RT 160-320	125805
• Tailstock / RT 200/250	125820

Type	D	H	H1	B	L	F	E	d	MT	Ratio	Weight	Part No.
RTS 250	250	205	140	252	310	14	12	30	Nr.3	1:90	78 kg	125 810
RTS 320	320	255	175	322	380	18	14	40	Nr.4	1:90	133 kg	125 815

### Rotary Table

# RT 100 • 160 • 200 • 250 • 320

### Options

Options	Part No.
• INDEX-feature / RT 160-320	125805
• Tailstock / RT 320	125825
• 3-jaw-chuck 250mm with flange for RT 320	125846

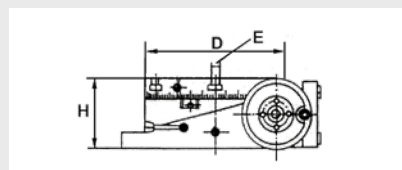
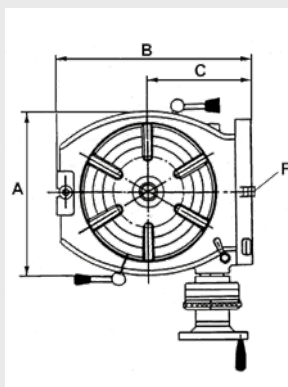

Type	D	H	A	B	C	E	F	MT	d	Ratio	Weight	Setup	Part No.
RT 100	110	85	118	150	90	10	10	2	25	1:90	7,25	hor. + vert.	125 800
RT 160	160	75	196	260	125	10	12	2	25	1:90	16,5 kg	horizontal	125 830
RT 200	200	100	236	285	150	12	14	3	30	1:90	30,5 kg	hor. + vert.	125 835
RT 250	250	110	286	328	170	12	14	3	30	1:90	44 kg	hor. + vert.	125 840
RT 320	320	120	360	410	210	14	18	4	40	1:90	75 kg	hor. + vert.	125 845

## Swivel Table

### ST

For precise machining or corner bores, angular cutting, angular grinding, etc.



- 1 scale gradation direct read-out at the table
- cast-iron frame, ground table surface and guideways

Specifications	ST 250	ST 300	ST 380
number of T-slots	3	3	3
T-slot spacing	mm 55	60	90
T-slot width	mm 12	12	16
swivel angle	± 50°	± 50°	± 50°
weight	kg 20	37	45
dimensions (LxWxH)	mm 254x178 x127	300x240 x165	381x254 x165
Part No.	129 335	129 340	129 345



## Swivelable Rotary Table

For small cutting operations on the bench or floor drill press

- dovetail guideways
- cast-iron construction

table size	235x145	320x145	510x240
height	mm 154	154	197
cross travel	mm 120	120	190
longitud. travel	mm 160	260	350
T-slots	mm 10	10	13
max. table load capacity	kg 85	100	140
swivel range	360°	360°	360°
handwheel incr.	mm 0,025	0,025	0,05
weight	kg 25	30	86
Part no.	106 001	106 003	106 006

## Compound Sliding Tables

Rigid and precise compound sliding table for coordinate drilling on radial, column, and bench drill presses

- cast-iron construction
- T-slot, coolant groove
- dovetail guides, adjustable

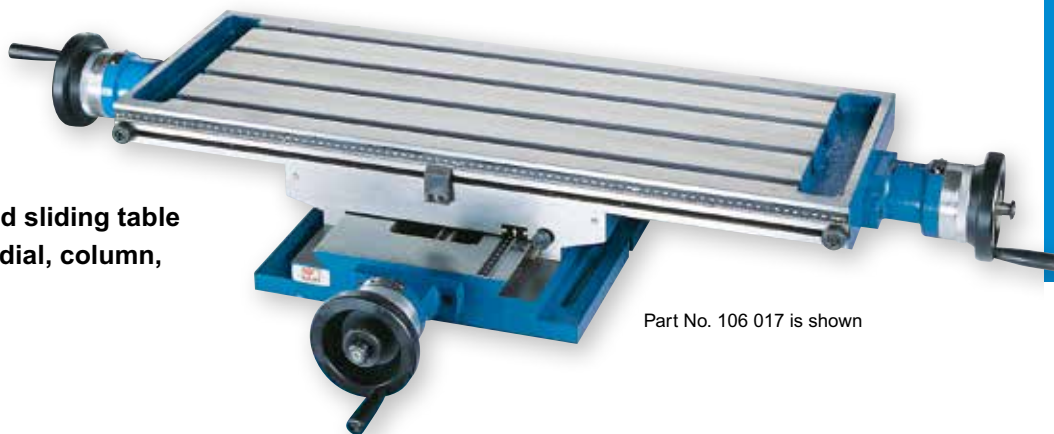

Part No. 106 017 is shown

Specifications			
table setup area	mm	730x210	855x295
table height	mm	196	160
X / Y axis travel	mm	500x210	620x240
T-slot width	mm	14	12x22

hand-wheel scale divisions		0.05	0.05
dimensions	mm	1065x625	1267x621
weight	kg	98	130
Part No.		106 009	106 017

## Hydraulic Machine Vise

# HNCS

High-grade machine vise for hydraulic clamping of parts

- hardened and ground surfaces ensure high-precision clamping, even when working with in-series connected vises
- 4 work surfaces
- pull-down system for maximum secure clamping
- spindle safety guard protects from chips
- face parallelism 0.02 mm



HNCS		100V	130V	160V	200V
jaw width	mm	100	130	160	200
clear opening	mm	0-125	0-180	0-240	0-280
jaw height	mm	48	55	58	63
overall height	mm	133	150	163	173
holding force	kN	36	46	56	71
weight	kg	25	38	57	78
Part No.		104 930	104 932	104 934	104 936



### Optional Equipment:

Dial for HNCS		100V	130V	160V	200V
dial diam.	mm	248	296	312	378
dial height	mm	27	30	34	44
Part No.		104 931	104 933	104 935	104 937

## Hydraulic Machine Vise

# HS

- hardened and precision-ground jaws and body
- clamping pressure is up to ten times as high as with conventional machine vises



HS 100 is shown

Specifications		HS 100	HS 125	HS 150	HS 200
width	mm	110	135	150	210
jaw height	mm	36	48	51	65
throat	mm	180	220	293	300
weight	kg	26	42,5	75	125
Part No.		105 096	125 024	125 028	125 029

- swivel-base mounted vise body, 360° swivel
- constant clamping pressure, unaffected by vibration and shock
- hydraulic power booster

## Precision Grinding and Control Vise

# PSS 70

- swivels on 2 levels, 360° horizontal, ± 45° vertical
- scale for precise minute readout
- screw for upward and downward swing
- for grinding, boring, milling, eroding
- weight: 12 kg

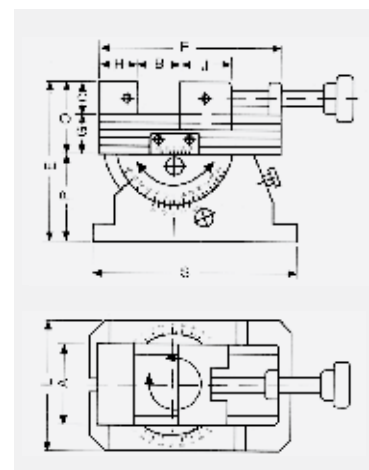

	A	B	C	E	F	G	H	J	L	O	P	S	N.W.	Part no.
PSS 70	70	80	30	137	160	32	33	45	110	62	75	180	12 kg	128 815



## Machine vise with pull-down system

### NZM

Made of high-quality cast-iron

- pull-down system: absolutely secure workpiece hold even during cutting of heavy parts
- hardened and precision-ground steel jaws
- dial turns 360° and has 1° scale division
- parallelism  $\pm 0,03$  mm / 100 mm
- precise, hardened jaw guides

Specifications		NZM100	NZM125	NZM160	NZM200
jaw width	mm	100	125	160	200
jaw height	mm	32	40	45	50
opening capacity	mm	100	125	170	230
height	mm	118	136	157	179
dial diameter	mm	160	187	230	268
weight	kg	16	24	34	56
Part No.		104 916	104 918	104 920	104 922

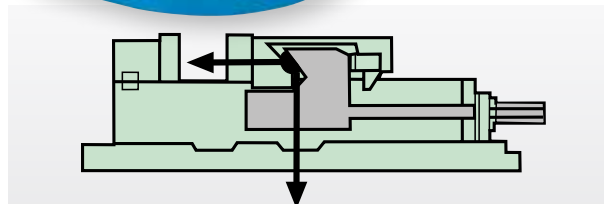

## Precision Machine Vise

### PMS

- swivels on 2 axes
- high precision vise for accurate and exact precisionmechanics work (also suitable for watch making, jewellery industries)
- swivels from horizontal (180°) to vertical (90°)
- turns 360° on a dial
- jaws are made of hardened and precision-ground tool steel

Specifications		PMS 50	PMS 75	PMS 100
width	mm	50	75	104
jaw height	mm	23	34	42
throat	mm	50	75	102
weight	kg	3,8	9,6	17,3
Part No.		125 010	125 011	125 012



III. PMS 50

## Universal Machine Vise

### UMS

- solid vise, ideal for drill presses
- deep hole bores for flexible clamping
- low height for cost-effective use of machine

Specifications		UMS 100	UMS 140	UMS 200
jaw width	mm	100	144	205
opening	mm	105	147	222
jaw depth	mm	42	50	63
assembly width	mm	170	189	250
height	mm	72	89	114
length	mm	460	610	788
deep hole dim.	mm	88 x 12	105 x 14	163 x 14
weight	kg	13	18	32
Part No.		125 030	125 031	125 032

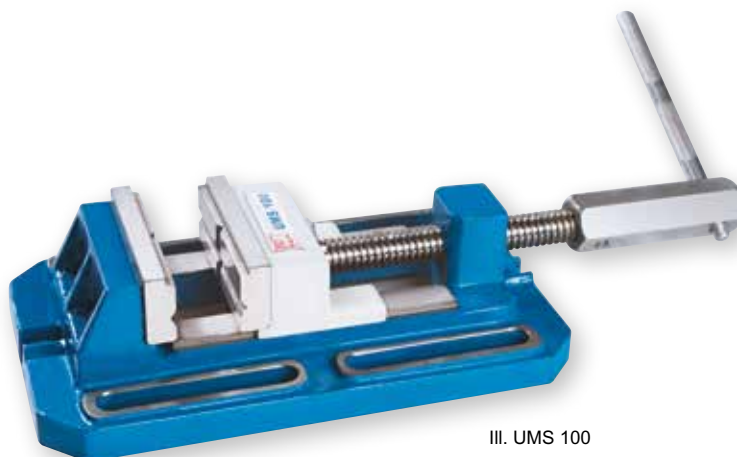

III. UMS 100

- Manually operated lathe chucks with spiral ring and centric clamping action for DIN 55029 spindle heads with Camlock stud bolts
- Lathe chucks are available with diameters up to 500 mm and short tapers up to size 11
- Precision-machined lathe chuck bodies are available in cast-iron and steel



### 3-Jaw Lathe Chuck



#### 3-jaw chuck / steel

Ø mm	Camlock mount	Speed rpm	Bore mm	Weight kg	Part No.
160	D1-4	4500	42	9	146 378
200	D1-4	4000	55	19	116 501
200	D1-6	4000	55	19	146 372
250	D1-6	3500	76	32	146 377
250	D1-8	3500	76	32	146 373
315	D1-6	2800	103	51	146 374
315	D1-8	2800	103	51	146 383
315	D1-11	2800	103	51	116 505
400	D1-8	2000	136	150	116 506
400	D1-11	2000	136	150	116 507

#### Soft Jaw Pads for 3-jaw chuck (cast-iron / steel)

Ø mm	Length mm	Width mm	Height mm	Part No.
160	78	25	41,5	116 550
200	90	27	43,0	116 551
250	103	32,5	51,5	116 552
315	120	37	55,0	116 553
400	140	42	64,5	116 554
500	140	42	74,5	116 555

### 4-Jaw Lathe Chuck



#### 4-jaw chuck / steel

Ø mm	Camlock mount	Speed rpm	Bore mm	Weight kg	Part No.
160	D1-4	4500	41	9	116 600
200	D1-4	4000	55	19	116 601
200	D1-6	4000	55	19	146 472
250	D1-6	3500	76	32	146 477
250	D1-8	3500	76	32	146 473
315	D1-6	2800	103	51	116 604
315	D1-8	2800	103	51	146 483
315	D1-11	2800	103	51	116 605
400	D1-8	2000	136	101	116 606
400	D1-11	2000	136	101	116 607

#### Soft Jaw Pads for 4-jaw chuck (cast-iron / steel)

Ø mm	Length mm	Width mm	Height mm	Part No.
160	78	25	41,5	116 650
200	90	27	40,0	116 651
250	103	32,5	51,5	116 652
315	120	37	55,0	116 653
400	140	42	64,5	116 654
500	145	60	82,0	116 655



## Quick-Change Tool Holder

5-piece Sets

### Set WA:

1 ea head A  
3 ea WAD 20x90  
1 ea WAH 20x90  
Part No. 103 193

### Set WB:

1 ea head B  
3 ea WBD 25x120  
1 ea WBH 32x120  
Part No. 103 195

### Set WD1:

1 ea head D1  
3 ea WD1D 63x180  
1 ea WD1H 63x180  
Part No. 103 197

### Set WE:

1 ea head E  
3 ea WED 20x100  
1 ea WEH 30x100  
Part No. 103 194

### Set WC:

1 ea head C  
3 ea WCD 32x150  
1 ea WCH 40x160  
Part No. 103 196

### Set WD2:

1 ea head D2  
3 ea WD2D 63x220  
1 ea. WD2H 70x220  
Part No. 103 198



- fits all standard german quick-change tool holder
- tool holder head and tool holder feature profileground gearing
- tool holders are clamped against the central body's gears by means of 2 chuck halves and an eccentric bolt
- repeat accuracy 0,01 mm
- tool holders can be adjusted to 40 different angles on the central body
- angle scale provided on head
- holder height adjustment with a thumb screw

**fits onto machine** (Part No. 270 021)

### Selection of tool holder head according to the respective table

size	W	A	E	B	C	D1	D2
Tool changer size	D	16 20	20 25	25 32	32 40	45 63	50 63
Machine:							
- Drive power, max.	kW	2.2	4.4	6.6	13.2	20	28
- Turning diameter	mm	150-300	200-400	300-500	400-700	500-1000	600-1100
Slide width, max.	z mm	100	120	150	180	200	250
Cutting edge height							
- min.	x mm	h + y	h + y	h + y	h + y	h + y	h + y
- max.	mm	x + hv	x + hv	x + hv	x + hv	x + hv	x + hv
Height adjustability	hv mm	11	17 15	20 11	40 35	30 35	30 20
Tool support	y mm	9	10 11	12.5 14	15 16	17 20	20 25
Height of tool							
max.	h mm	16 20	20 25	25 32	32 40	45 63	50 63
Overall width, max.	v mm	100	125	150	192 202	202 230	234 242
Overall height	s mm	54	68 75	75	105	122	135
Throat, max.	u mm	48	60 71	71	92 102	102 112	116 124
Bore, max.	t mm	31	31	51	70	40	80



WA 103 189	WB 103 191	WC 103 192	WD1 103 360	WE 103 190
WAD a 16 l 75 103 271 WAD 16 90 103 272 WAD 20 75 103 273 WAD 20 90 103 274	WBD 25 120 103 291 WBD 25 140 103 292 WBD 32 120 103 293 WBD 32 140 103 294	WCD 32 150 103 301 WCD 32 170 103 302 WCD 40 150 103 303 WCD 40 170 103 304 WCD 45 170 103 305	WD1D 40 180 103 364 WD1D 50 180 103 365 WD1D 65 180 103 361	WED 20 100 103 281 WED 25 100 103 282
WAH d 20 l 85 103 275	WBH 34 130 103 295 WBH 18 120 103 298	WCH 40 160 103 306 WCH 50 160 103 307	WD1H 63 180 103 362	WEH 30 100 103 283
WAJ d 30 l 80 103 276	WBJ 40 120 103 296	WCJ 40 160 103 308 WCJ 50 160 103 309	WD1J 63 180 103 363	WEJ 30 100 103 284 WEJ 40 100 103 285
WAA-AO 103 277	WBA-A2a 103 297	WCA-A3a 103 310		WEA-A2a 103 286

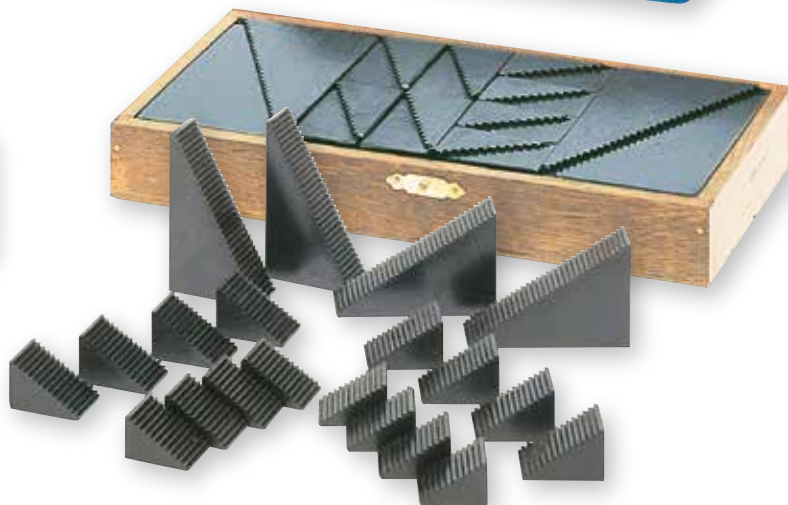
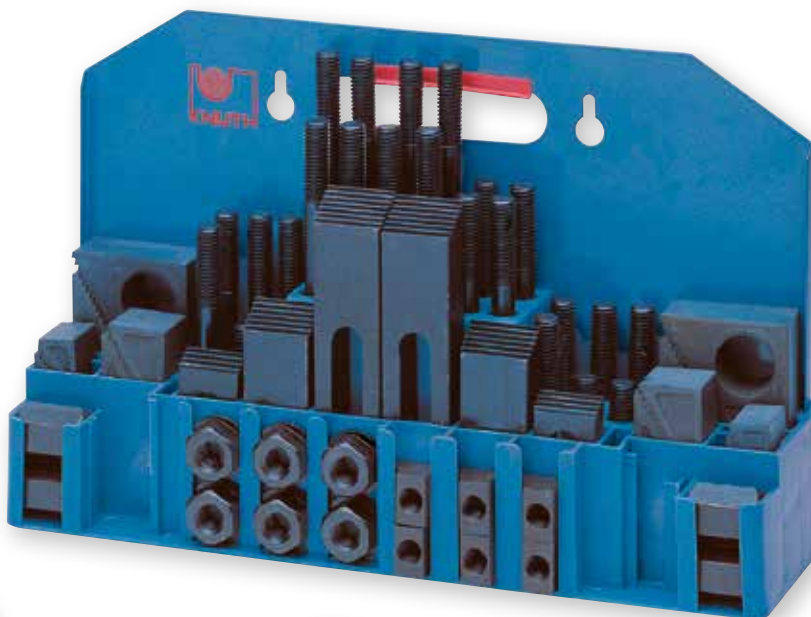

### De Luxe Clamping Tool Set

- in a convenient, sturdy steel magazine, 52 parts
- 24 stud bolts, 4 each in the lengths 75, 100, 125, 150, 175, 200 mm
- 4 extension nuts, 6 stepped clamps (3 pair), 6 T-slot nuts, 6 hexagon nuts flanged, step blocks

### Stud Bolt Set, and T-Slot Nuts

- 38 parts
- 24 stud bolts, 4 ea in the lengths 75, 100, 125, 150, 175, 200 mm
- 6 T-slot nuts
- 4 extension nuts
- hexagon nuts flanged

### Set of Step Blocks

- 20 each (10 pairs) in wooden box
  - black-finished steel
- Part No. 105 340

Thread	Part No.
M 10	105 290
M 12	105 295
M 14	105 300
M 16	105 305

Thread	Part No.
M 12	105 355
M 14	105 360



### 2-PC. swivel hold-down clamp sets

- high quality steel, black-finished
- available in pairs only

Length	Bore for stud bolts	Part No.
100	M 12	105 790
100	M 14	105 795
125	M 16	105 800



### Dial Gauge

- accuracy acc. to DIN 878
  - matte-finish chrome-plated metal encl.
  - clamping shaft 8mm h6
  - outer race with 2 adjustable tolerance markers
  - gradation 0.01 mm
  - measuring range 10 mm
- Part No. 129 020



### Precision Dial

- accuracy and design acc. to industry standard
  - measuring range 0 - 1.27 mm
  - clamping shaft 8 mm
  - smallest increment 0.002 mm
- Part No. 129 022



### Precision Dial Gauge

- accuracy acc. to DIN 2270
  - automatically reversing tracer arm
  - rotating outer race for zeroing
  - stainless steel precision bearing for friction-free adjustment of tracing point
  - gradation 0.01 mm
  - measuring range 0.8 mm (0-40-0)
  - including wooden case
- Part No. 129 065

## Magnetic micrometer Holders

### 3-in-1 Clamping

- Just turn the clamping knob for a quick and secure fixation of all 3 motion points
- foot dimensions 63 x 50 x 55 mm
  - holding power 60 kg
- Part No. 108 796



shown with optional equipment

### Hydraulic high-precision magnetic measuring tripod

- central clamping with 1 rotating knob
  - high clamping force via hydraulics
  - foot dim. 65x50x55mm
  - holding power 50 kg
- Part No. 108 810



### Individual clamping

- measuring column 12 mm Ø x 181 mm
  - transverse arm 10 mm Ø x 150 mm
  - foot dimensions 63 x 50 x 55 mm
  - holding power 60 kg
  - plus fine adjustments
- Part No. 108 800



## External Micrometer Set

### 6-pcs. 150 - 300 mm

- measuring range 25 mm each
- accuracy in acc. with DIN 863
- readout 0.01 mm
- satin chrome-plated scales
- micrometer screw diam. 8 mm
- C-frame with hand protection
- thimble diam. 17 mm
- including ratchet
- spindle pitch 0.5 mm
- with adjustment gauge
- including wooden case
- measuring range 150-175, 175-200, 200-225, 225-250, 250-275, 275-300 mm

Part No. 129 012



## External Micrometer Set 6 pcs. 0 - 150 mm

- accuracy acc. to DIN 863
- readout 0.01 mm
- satin chrome-plated scales
- micrometer screw diam. 6.35 mm
- tungsten carbide tipped measuring surfaces
- C-frame with hand protection
- thimble diam. 17 mm
- including ratchet
- spindle pitch 0.5 mm
- measuring range 25 mm a. up with adjustm. gauge
- including wooden box
- measuring range 0-25, 25-50, 50-75, 75-100, 100-125, 125-150 mm

Part No. 129 010



# Clamping tools

Quick and easy online orders



**Basic chuck**

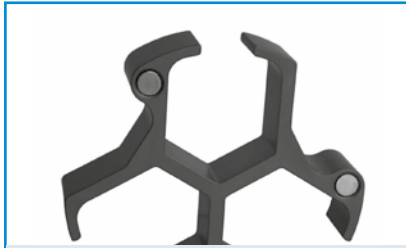

**Lathe Chuck Stop**



**2- / 3-jaw power chuck**



**3-Jaw Wedge Bar Power Chuck**

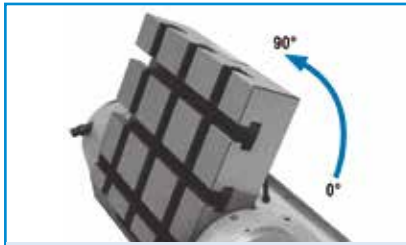

**Swiveling Setup Table**

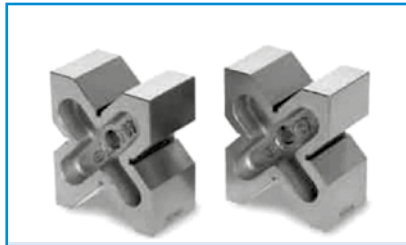

**V-Blocks**

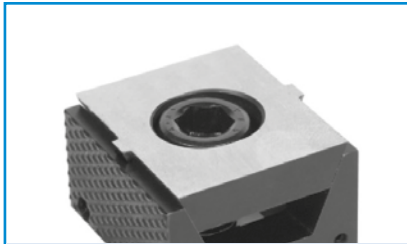

**Wedge-actuated chuck**



**Driven coordinate tables**

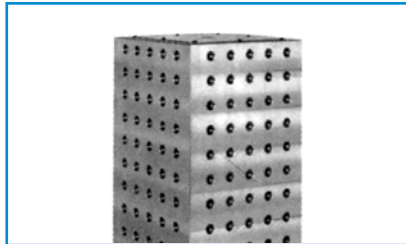

**Grid cube**



**Tap holder**



**Face driver**

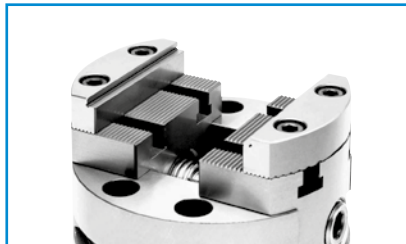

**Centric chuck**

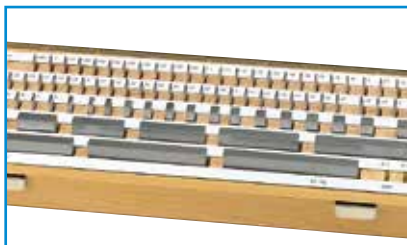

**Set of blocks gauges**



**Dial gauges**



**Safety guard with magnetic foot**

## X.Pos 3.2

Position Indicators - an absolute necessity for all machine tools



- As new addition or for retrofitting machine tools like milling machines and lathes, including measuring machines
- The new generation of displays is more powerful, robust, and reliable
- High-resolution 7" color display and powerful CPU for instant display of all functions and values
- The new generation of displays uses system-on-chip technology to integrate all functions on a chip for a more compact and reliable design
- Easy mounting and maintenance-free operation
- Increased accuracy
- Reduced error rate
- Higher operator safety
- Significant time savings
- Increased productivity
- User-specific functions
- Resolution 0.005 mm
- Default coordinates
- Pocket calculator function
- Conversion mm/inch

### Milling Machine Functions:

- Calculation of hole circle pattern
- Calculation of hole line pattern
- Coordinate storage
- Skew coordinate function
- Arc coordinate function
- Radius machining function, simple

### Lathe Functions:

- Display of top slide (Z0) and bed slide (Z1) either individually or as differentiation/summation circuit for lathes
- Storage for 9 tools
- Taper function
- Radius / diameter toggle
- Fully compatible with older X.pos scales - upgrade now! X.pos - Increase your productivity, quality, and comfort, available in many languages (English, German, Spanish, Italian, French, Czech, Portuguese, Russian, Turkish, Swedish, Romanian, Japanese, Korean, Arabic, Hindi, and many more)

Art.-Nr. 123461

### Mini precision gauges (including metal jacket)

Measuring length*	Part No.
100 mm	111 501
150 mm	111 502
200 mm	111 503
250 mm	111 504
300 mm	111 505
350 mm	111 506
400 mm	111 507
450 mm	111 508
500 mm	111 509
550 mm	111 510
600 mm	111 511
650 mm	111 512
700 mm	111 513
750 mm	111 514
800 mm	111 515
850 mm	111 516
900 mm	111 517
950 mm	111 518
1000 mm	111 519
1100 mm	111 521
1200 mm	111 523
1300 mm	111 525
1400 mm	111 527
1500 mm	111 529
1600 mm	111 531
1700 mm	111 533
1800 mm	111 535
1900 mm	111 537
2000 mm	111 539
3000 mm	111 559

\* Minimum length = max. mechanical travel  
Longer measuring lengths upon request

**We set up your new machine, make all adjustments and perform a test run on site.**

Individualized customer care at your site, which includes instructing the operator in the use of all standard functions of the new machine, is the quickest and safest way to implement new technology into your production.

**Your advantages at a glance**

- Professional assembly and installation
- Set up and final acceptance test
- Geometric adjustments on site
- Function test and operator instruction

Our StartUp packages are customized to meet the technology requirements of the respective machine and can be tailored for any system size. We offer this service for all KNUTH machines.

**Set up and initial start up of a cutting system**

- After transporting the machine to its final location and after all required energy/utility connections have been provided by the customer
- Support provided to our technicians by the buyer's personnel and devices (forklift/crane)
- Instruction/training of operators in the use of the cutting system by our technicians on site for about 1 to 2 days

**StartUp cutting system**

**Part No. 270300**

**Set up and initial start up of a CNC-controlled or conventional machine tool**

- Removal of transportation locks
- Assembly of machine components
- Alignment of machine tool
- Fill up operating fluids
- Check operation of all machine components
- Turn on machine
- Test run
- Training on how to use the machine functions
- Training on how to maintain the machine

**StartUp conventional machine tool**

**Part No. 270100**

**StartUp for CNC Machine Tool**

**Part No. 270200**



**Operator training for CNC machine tool**

- Set-up and operating your CNC machine
- Programming your machine using a sample workpiece

**CNC machine tool training  
Part No. 270202**





Machine Insurance

## KNUTH-Protect

Financial security in case of unforeseeable events

Production machines are exposed to a wide variety of risks every day. Despite advanced technology, careful handling and proper maintenance, expensive damages are possible in the long term - just the time and the extent are unknown factors. With the KNUTH-Protect Machine Insurance, the damage risk can be reduced to a predictable dimension.

In general, this warranty covers machine damages that are caused by human error, technical defects and force majeure / natural hazards. The machine is warranted for 24 months or 3,600 operating hours from the date of delivery.

### KNUTH Protect Machine Insurance

up to € 75,000

Part No. 270500

up to € 150,000

Part No. 270501

up to € 250,000

Part No. 270502



Maintenance

## KNUTH-Maintenance

Regular maintenance will pay for itself

A deciding factor and important goal for the success of production businesses is the reliability of their machine fleet. Regular maintenance is an important building block to achieve this goal.

In addition to completing all required routine maintenance tasks, like oil changes or readjustments, the KNUTH service technician will also provide you with a report on the current condition and state of your machine. Our expertise can help you take the correct measures in time, so your machine will continue to be a reliable component of your production facility or workshop.

In our 380 sqm large spare parts warehouse, we keep up to 35,000 original replacement parts in stock to guarantee high availability.

### Customized maintenance package for cutting systems

- Testing of machine function
- Testing of peripherals
- Testing of safety features
- Monitoring and adjustment of all machine components
- All work according to maintenance plan
- Report/log of performed work

### Maintenance package for cutting system\*

Part No. 270303

### For CNC and conventional machine tools we offer:

- Testing of machine function
- Testing of safety features
- Checking machine geometry
- Monitoring and adjustment of all machine components
- All work according to maintenance plan
- Report/log on performed work

### Maintenance packages for CNC machine tool\*

Part No. 270203

### Maintenance package conv. machine tool\*

Part No. 270103

\* Prerequisites: Operational and accessible machine. Package price plus travel expenses, materials not included



## KNUTH Live Demo

Don't miss this opportunity to check out machines at our headquarters in Germany!



Nothing is more convincing than your own experience!

Visit us at our company headquarters in Wasbek or at one of our branches for an individual demonstration of our machines, and talk to our technicians and engineers.

Take a look behind the scenes! Learn more about our expertise and services and meet the employees that make it possible!

Let these machines convince you of their superior quality and performance.

**Make an appointment for a personal demonstration!**

We are looking forward to your visit.

## Just like live

If you cannot visit in person, KNUTH provides videos which show machining operations on test pieces. In these videos you see and hear how the workpiece is machined. These videos provide you with a good basic understanding, and you can clarify the smallest details with our technician. Talk to one of our sales experts.





## Everything for metalworking under one roof

In 16.000 m<sup>2</sup> of exhibition area at our company head office in Wasbek, customers will find machines and technologies from all areas of machining and sheet metal working ready for demonstration and available for delivery at short notice.



**Open for you 24/7:** Take a virtual tour through our warehouses, spare parts warehouses and workshop with Google Street View.

### Corporate Headquarters in Wasbek

**KNUTH Werkzeugmaschinen GmbH**

Schmalenbrook 14  
24647 Wasbek / Neumünster

Tel. **+49 4321 - 609-0** • Fax +49 4321 - 68900  
**info@knuth.com**

Business hours: Mon - Thu: 8:00 a.m. - 05:00 p.m.  
Fri 8:00 a.m. - 03:00 p.m.  
Saturday: by appointment only

### Customer Care Export

Tel. +49 4321-609-1116 • Fax +49 432-1609-197  
**sales-export@knuth.com**

### Customer Care GUS / Russia

Tel. +49 4321-609-1115 • Fax +49 432-1609-197  
**sales-cis@knuth.com**

### MACHINE SERVICE

KNUTH Technical Service Help Desk

**E-Mail** **service@knuth.com**  
**Tel.** **+49 4321 609-273 / -268**

KNUTH Spare Parts Service

**E-Mail** **info@knuth.com**  
**Tel.** **+49 4321 609-258 / -265**

### KNUTH SA (Pty) Ltd

1 Sam Green Street, Tunney Ext 7  
Germiston South Africa

Tel. **+27-11-822-4610** • Fax +27-11-822-4710  
**info@knuth.co.za**

Business hours:

Monday - Thursday 08.00 a.m. - 05.00 p.m.  
Friday 08.00 a.m. - 03.00 p.m.

Managing Director: Karsten Knuth, Philip Knuth, Kristian Knuth  
Legal Structure: Gesellschaft mit beschränkter Haftung (GmbH)  
[Incorporated with Limited Liability]

Registry Court: Amtsgericht Kiel  
Commercial Register: HRB 1554  
Sales Tax ID No.: DE 214088559

# The KNUTH Fabricating Center

## Cutting and Forming Expertise

Machines for all areas of fabrication from a single source!

We offer comprehensive consultation.

The complete portfolio starts on page 214.



**Plasma-Jet Options:** Tube cutting systems, cutter heads for bevels, oxy-fuel cutting



**Water-Jet 2D and 5-axis machines,** cutting solutions for any material



**ACE Laser:** Complete solutions for your cutting tasks

# Your application is the deciding factor

Productive bending machines for customized solutions starting on p. 254



[www.knuth.com](http://www.knuth.com)

KNUTH Werkzeugmaschinen GmbH • Schmalenbrook 14 • D-24647 Wasbek • Tel. +49 (0)4321 609-0 • [info@knuth.com](mailto:info@knuth.com)

V0/EN-11-2021