

**Product Brochure**



## Compressed air at its best

**Our mission:** The SPX Dehydration & Process Filtration corporate group has united some of the market leaders in compressed air treatment. This united operation allows SPX Hankison to provide you with comprehensive systems solutions, a wealth of experience and technical competence and provide added value from a single source. In aiming to satisfy our customers' needs we follow the guideline that the sum of all features makes up the optimum. You can therefore have confidence in our outstanding product range and rely on our experienced specialist dealer network to provide assistance and support, ensuring we play our part in your success.

**Constant innovation:** continuous developments, trend-setting innovations and evaluation of the latest technical advances allow us to provide our clients with the best technical and economic solutions to satisfy their individual needs. Constant evaluation of products and the focus on the reduction of operating and energy costs are not mutually exclusive, on the contrary. However we will demonstrate this and more in the following pages.

**Discernible quality:** is a living tradition within our company. Trust in the market leader in compressed air treatment and take advantage of our recognised ability and experience. Numerous awards and certificates are a testament to our history of innovation and expertise and present an unmistakable argument in favour of our being your No1 choice. All our products for the treatment of compressed air carry the Hankison commitment to quality and performance, it is not in our nature to compromise, and with Hankison you do not have to.

**Clear philosophy:** our commitment to the customer, their requirements, their individual needs and the provision of an optimal solution to them form the focus of our product development and passion. SPX Hankison, assure you of their commitment to providing the perfect balance between product and service. Our user-friendly control systems as well as our modular filter systems facilitate their usage and integration into existing processes without problems. The simplicity and functionality of our products are designed to provide ease of use and application.

**Our passion:** is to provide cost effective, efficient, quality products to provide clean, dry compressed air. We are passionate about what we do and our satisfaction comes from knowing that we are playing our part in optimising our clients processes. Please come along with us. The following pages will fully detail the products and equipment available to provide effective process solutions.

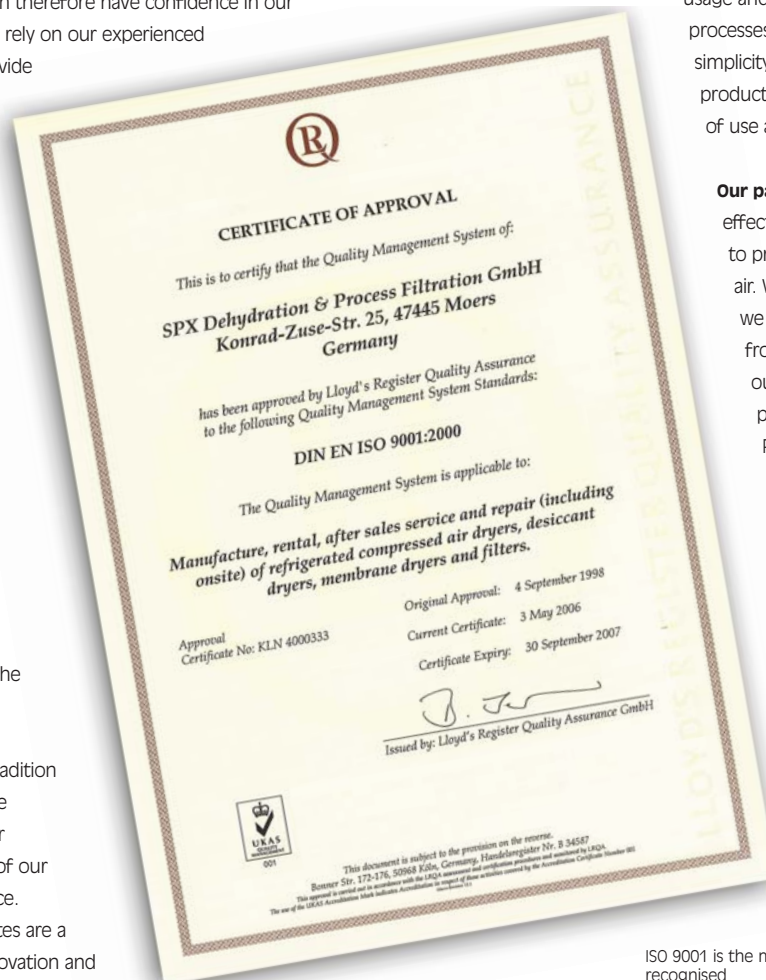

ISO 9001 is the most internationally recognised and accepted quality assurance certification programme

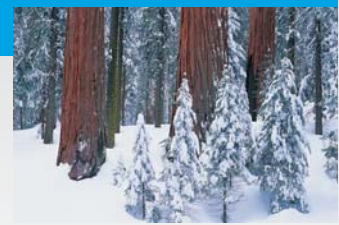

## Your needs....

a perfect solution to moisture and contaminanation

## ... & our solution

### Introduction

4



### The Dryers...

... are units designed to remove water vapour and lower the dew point temperature of compressed air, preventing liquid water from being transported downstream, however it does not eliminate all the entrained contaminants.

### Refrigerated Compressed Air Dryers

Ideal for minimum dew point temperatures of +3°C.

These are used where the air system is installed in locations where temperatures will always be maintained above freezing point.

6



### Desiccant Dryers

For dew point temperatures from +3°C to -70°C or lower.

These are used where the air system is exposed to temperatures below freezing or extremely dry air is required for critical applications. The water vapour adsorbed during the drying process is extracted by the desiccant media.

17



### Membrane Dryers

For dew point temperatures from +4°C to -40°C.

These are used for applications where there is limited installation space, no power source available, or explosive or corrosive conditions exist.

20



### Filters...

... and Separators are used to remove liquid water, solid and gaseous contaminants that can adversely affect the air system. Our compressed air filter range can provide the exact degree of filtration required for every application.

22

### Engineering Figures

24

## Compressed Air a source of energy

Are you aware? Compressed air has been effectively used in a wide variety of manufacturing and commercial operations for more than 2000 years. Many processes are only possible because of compressed air.

The safe, cost-effective production, treatment and application of compressed air is very important, both in general terms and especially for your processes.

## Air treatment - convincing arguments

### Contaminants of compressed air

Compressed air is contaminated because solid particles and water vapour enter the compressor along with the atmospheric air. Once atmospheric air passes through a compressor operating at 7 bar, the air is compressed to 1/8th of its previous volume, yet still contains the same amount of contaminants. Those contaminants are wear particles, oil aerosols and oil vapour which are concentrated inside the compressor while rust and pipe scale are added into the air distribution system.

Compressed air at 7bar contains over 8 times more water, oil and other contaminants than the atmospheric air.

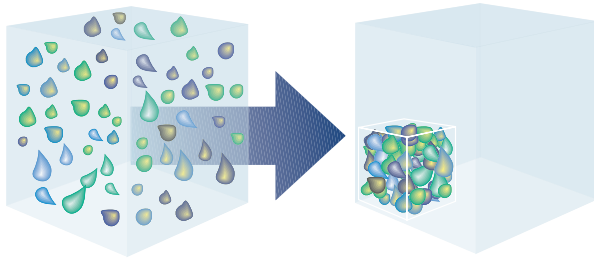

### Where does moisture come from?

Relative humidity is the amount of moisture in the air compared to the total amount the air could hold at a certain temperature.

The amount of moisture air can retain is determined by its temperature and, to a lesser extent, its pressure. Any sufficient drop in temperature or increase in pressure will cause moisture to condense out of the air.

## Consequences

Without proper treatment, compressed air contains solid, liquid and gaseous contaminants reducing the efficiency of your compressed air system, increasing your operating expenses, causing instrument and control failure, and jeopardizing product quality.

You can eliminate contaminants and provide the quality of compressed air your processes require. Take a look at our air treatment products presented in this brochure.



## General contaminations of compressed air are:

**Liquid contaminants:** water and oil droplets

**Solid contaminants:** wear particles, dust and dirt

**Gaseous contaminants:** as oil vapour and water

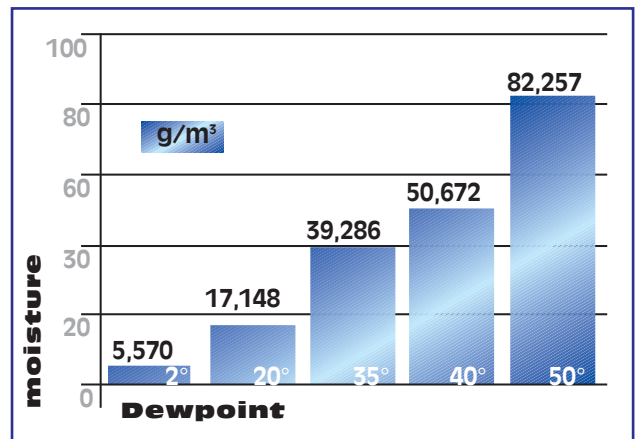

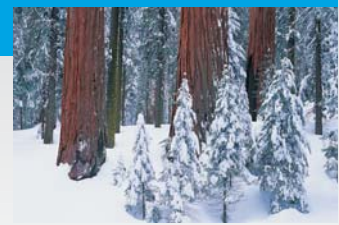

## Condensation



is... the changing of physical conditions from water vapour into liquid. Increases in pressure would normally cause moisture to condense out of the air. However, during the compression process, the air temperature rises due to frictional heat, increasing its ability to hold water vapour.

As air leaves the compressor and travels throughout the system, its temperature will drop. Once the air temperature drops below the pressure dew point temperature, water droplets begin to condense. It is necessary to remove the moisture and contaminants from the air system in order to lower the dew point and to avoid operating problems, costly maintenance, and repair expenses.

**Think about this:** Do you own a swimming pool? One 5m<sup>3</sup>/min compressor (based on an ambient temperature of +20°C, 1 bar, 70% air moisture) generates within 50 weeks (24h use) over 21.600 litres from your compressed air. That's just enough to fill your swimming pool. Provided that you have one, of course!

To prevent water from harming your air system choose a dew point temperature below the lowest ambient temperature to which your compressed air system will be exposed.

**SPX Hankison meets the toughest standards and therefore offers certified quality to you.**

Member of



Meeting global standards



**SZU CRN UDT**

**We are able to guarantee more efficiency:**

- Service
- User-friendly features
- We can assure you of the innovation, quality and reliability you deserve.
- Trust in the market-leader.

## Air treatment a question of efficiency

**The situation:**

- Contaminants in compressed air adversely affect all components of the air distribution system
- In addition, precious energies are wasted

**With the proper compressed air treatment equipment:**

- Operating costs are reduced
- System power/production is maintained
- Production quality is improved.

Don't risk poor quality and a bad reputation, when you can offer the best product quality possible to your customers.

### Worth a mention!

Pressure drop is a logical consequence of the process of air treatment. This pressure drop affects your operating costs. A high pressure drop increases your expenses incalculably. Minimize your costs - keep your pressure drop to a minimum.

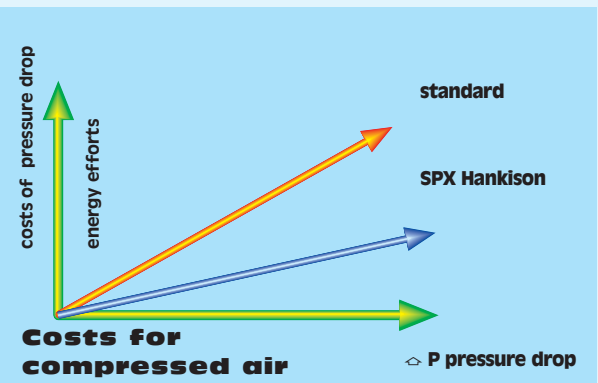

The special design of our dryers and filters ensure a minimum of pressure drops. Just think about your potential savings for a moment and then make a decision.

**How to select the perfect dryer for your application -**

**This depends on your individual requirements:**

- Pressure dew point (°F, °C)
- Flow capacity (scfm, Nm<sup>3</sup>/hr, Nm<sup>3</sup>/min, l/sec)
- Inlet air pressure (psig, bar, kg/cm<sup>2</sup>)
- Inlet air temperature (°F, °C)
- Ambient or cooling water temperature (°F, °C)

## HHD Series Refrigerated Air Dryers - Improving Productivity

### Hankison HHD Series Refrigerated Air Dryers Improve Productivity

Since 1948, people around the globe have relied on Hankison to deliver the right solutions to efficiently meet the needs of today's applications for compressed air treatment. HHD Series non-cycling refrigerated compressed air dryers offer the right combination of technology and simplicity to keep your air system at a dry +3°C pressure dew point, from 20 through 800 m<sup>3</sup>/h.

### Gain Efficiency

Air-powered products and processes operate best with clean and dry compressed air. Productivity improves. Rejects decrease. Maintenance personnel are able to be proactive and work from their schedule. The entire facility runs smoothly and contributes to financial stability and competitiveness.

### Built-in Durability and Reliability

All HHD Series dryers are built for durability, in a space-saving design. Sturdy sheet steel is formed and protected by an epoxy-based powder coat finish. Reliable reciprocating refrigeration systems use environmentally friendly R-134a refrigerant. R-134a is known for its ability to maintain stable temperatures to protect the integrity of the +3°C pressure dew point. HHD Series can handle the pressure.

### Dry Compressed Air - Pure & Simple

Research indicates that many customers want reliability and dry compressed air at an affordable price. No fancy bells and whistles - just dry air, pure and simple. The HHD Series non-cycling dryers were designed to meet these demands.

### How it Works

#### Models HHD 21 through HHD 101

Warm saturated air enters the Evaporator (A) where it is cooled by refrigerant being controlled by a Constant Pressure Expansion Valve (B). Water vapor condenses into a liquid for removal at the moisture separator (C) by an Automatic Drain (D). The cold, dry air is reheated as it passes through the Reheater (E). This prevents pipeline sweating. The Static Condenser (F) eliminates the need for a cooling fan and simplifies the system.

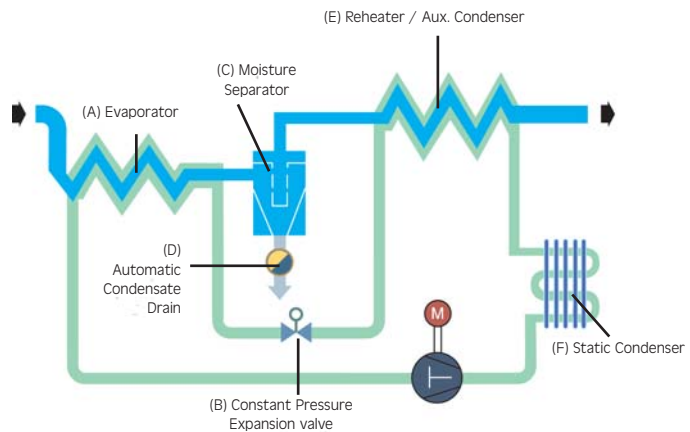

#### Models HHD 151 through HHD 800

Warm saturated air enters the air-to-air heat exchanger (A) where it is pre-cooled by the outgoing chilled air, and then passes through the air-to-refrigerant (evaporator) heat exchanger (B) where it is further cooled by the refrigeration system. Water vapor condenses into liquid droplets to be removed by the Moisture Separator (C) then, discharged from the dryer by an automatic drain (D). Chilled dry air returns through the air-to-air heat exchanger (A) where it is reheated before exiting the dryer.

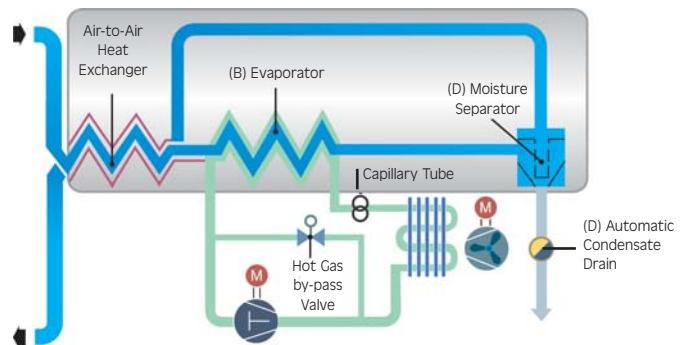



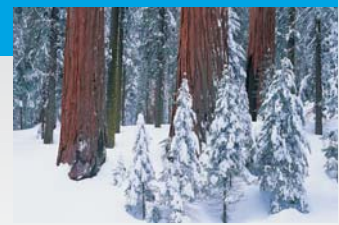

## HHD Series - Standard Features

- Easy to install package saves time. Simply connect the pipes and plug in the power cord.
- Adapts to system needs without complicated controls. Fully automatic operation saves money.
- Every unit comes pre-assembled with quality components. Long service life.
- Steady +3°C pressure dew point. Ensures maximum moisture removal every day.
- On/off switch illuminates when compressor is on
- At-a-glance control panel dew point indication verifies performance (HHD 31 - HHD 800)

## HHD Series - Models through 100 m<sup>3</sup>/h

- Static condenser recycles waste heat to eliminate cold, sweaty pipes
- Integral Moisture Separator
- Timer operated drain with isolation valve/strainer (float drain on HHD 21)
- On/off switch illuminates when compressor is on

## HHD Series - Models 150 to 800 m<sup>3</sup>/h

- Integral 304 stainless steel heat exchanger, mesh demister and, moisture separator for long life
- Timer operated drain includes isolation valve/strainer to protect valve from rust and scale
- Panel mounted drain timer controls (HHD 400 - 800)
- LED style dew point indicator (HHD 400 - 800)
- Panel filter captures ambient dirt and dust to keep condenser clean



Refrigerated Compressed Air Dryers

## **COLDWAVE™ REFRIGERATED COMPRESSED AIR DRYERS HHD*plus* SERIES & HDS SERIES**

Hankison ColdWave™ refrigerated dryers feature our most advanced heat exchanger technology. Being the global leader in compressed air treatment is what continues to set the Hankison brand apart. Since L.E. Hankison patented the Condensifilter™, (forerunner to the refrigerated air dryer) in 1943, Hankison engineers have set the industry standard for refrigerated dryer technology. ColdWave™ heralds the next generation of Hankison high performance refrigerated dryers designed for quality and reliability.



### **COLDWAVE DRYERS REDUCE OPERATING COSTS Manufacturing Energy Efficient Solutions.**

For more than half-a-century, Hankison quality, performance and reliability set the standard for global compressed air treatment products. The tradition continues. Industry leading ColdWave™ Technology infuses the latest generation of refrigerated dryers with rugged durability, energy-efficiency and long service life. It's no wonder that leaders of industry specify Hankison products to protect their critical products and processes from contaminants.

Our mission is to reduce the operating expenditures of compressed air users by removing impurities from their air systems. Utilizing environmentally friendly refrigerants, Hankison ColdWave™ dryers deliver stable ISO8573.1 Quality Class 4 and Class 5 pressure dew points and, remove solid particulates, and oil from compressed air systems across all operating flows.

#### **COMPRESSED AIR SYSTEM IMPURITIES**

<b>Impurities</b>	<b>HHD<i>plus</i> &amp; HDS Series Air Treatment Stations</b>	<b>Reduce General Plant Operations Costs</b>
<b>Moisture (Water)</b>	ISO 8573.1 Quality Class 4 and Class 5 pressure dew points	<ul style="list-style-type: none"> <li>• Reduce wear and maintenance costs of pneumatic devices</li> <li>• Reduce product spoilage</li> </ul>
<b>Particles (Rust &amp; Dust)</b>	HF Series Grade 9 Separator/Filter 3 micron particulate	<ul style="list-style-type: none"> <li>• Reduce work stoppages</li> <li>• Reduce rust, scale and leaks in air lines</li> </ul>
<b>Oil (Liquid)</b>	HF Series Grade 5 Oil Removal Filter 0.008 ppm (0.01 mg/m <sup>3</sup> )	<ul style="list-style-type: none"> <li>• Reduce malfunctions of control and air logic instruments</li> </ul>





### ISO 8573.1 CLASS 4 AND CLASS 5 DEW POINT SPECIFICATIONS SAVE ENERGY

All compressed air systems must be evaluated individually to develop a specification for compressed air treatment. The majority of compressed air users benefit from Quality Class 4 and Class 5 moisture control due to the low overall cost of operation and low initial purchase price. This technology is ideal for pressure dew point requirements above freezing. Systems with more stringent dew point requirements benefit from desiccant or membrane technologies that offer dew points to ISO8573.1 Quality Class 1.

### DEW POINT CONTROL IMPROVES PRODUCTIVITY

At 1700 m<sup>3</sup>/h, the difference between a 3°C and 16°C pressure dew point can result in 360 l of liquid water going downstream...every week. That is why Hankison strongly recommends high-performance products for maximum contamination removal at the lowest overall operating cost.

### DEVELOP AN AIR DEMAND PROFILE TO SAVE ENERGY

Compressed air demand in most plants fluctuates significantly. Hankison offers compressed air users who specify ISO 8573.1 Quality Class 4 and Class 5 pressure dew points, two refrigerated drying technologies to choose from. High performance HHD*plus* Series and HDS Series dryers include integral 3 micron Grade 9 filtration to deliver high-quality air. Add the integral 0.008 ppm (0.01 mg/m<sup>3</sup>) w/w Grade 5 Cold Coalescing filtration option to gain premium air quality, simplify installation and benefit from true, Air Treatment Stations. Both optimize energy saving opportunities for various compressed air demand profiles. The chart below will help you determine which solution is best for your application

### MATCH AIR DEMAND PROFILES WITH THE OPTIMUM COLDWAVE SOLUTION TO SAVE ENERGY

#### ColdWave HDS Series, 1500 - 10800 m<sup>3</sup>/h



##### Energy Saving Air Treatment

- Optimize energy savings for variable air demand profiles that range from 0% to 100% capacity.
- Digital control PLC allows user to track cumulative energy savings.
- Digital Evaporator coupled with an innovative Digital Scroll refrigeration system.

#### ColdWave HHD*plus* Series, 211 - 10800 m<sup>3</sup>/h

##### Continuous Demand Air Treatment

- Rugged reliability and value for steady demand profiles with 75% to 100% total average air flows.
- Energy Management Monitor (emm™) PLC comes with "schedule mode" which turns dryer on and off to optimize energy savings in one or two shift operations. (Models HHDp 381 and larger)

Air Demand Profile	Hankison Solution
 <p>Fluctuating Demands (1 to 3 shifts)</p>	HDS Series
 <p>Reduced Demands (1 to 3 shifts)</p>	HDS Series or HHD <i>plus</i> Series in schedule mode
 <p>Peak Demands (1 to 3 shifts)</p>	HDS Series or HHD <i>plus</i> Series in schedule mode

## THREE HANKISON TECHNOLOGY PLATFORMS FOR PURE, CLEAN, DRY AIR

### 1. HANKISON COLDWAVE™ HEAT EXCHANGER TECHNOLOGY

The ability to select and tailor the most reliable and efficient heat transfer systems for the application of compressed air has been a Hankison tradition for decades. Hankison only uses environmentally-friendly HFC R-134a and R-404a refrigerants that comply with the Montreal Protocol of 1989, for all HHD*plus* and HDS Series ColdWave™ dryers. Each features Hankison's most advanced heat exchanger designs.

Featuring non-fouling, large-bore, smooth heat exchange surfaces, ColdWave™ heat exchangers shrug off airborne contaminants. Dirt, rust and scale have no place to get trapped and are swept through these heat exchangers by the compressed air. Unlike many competitive designs, these do not require pre-filtration thereby, reducing capital, installation and operating costs.

#### ColdWave™ Technology

Advanced metal forming and bonding techniques produce industry leading ColdWave™ heat exchangers. Crafted from premium grade 316SS, layers of sinusoidal flow paths form large, smooth channel flow cavities that provide low-pressure drop, unparalleled performance and superior reliability. These are the most advanced high-performance heat exchangers in the industry, and are standard equipment on all HHD*plus* Series and HDS Series ColdWave™ dryers.

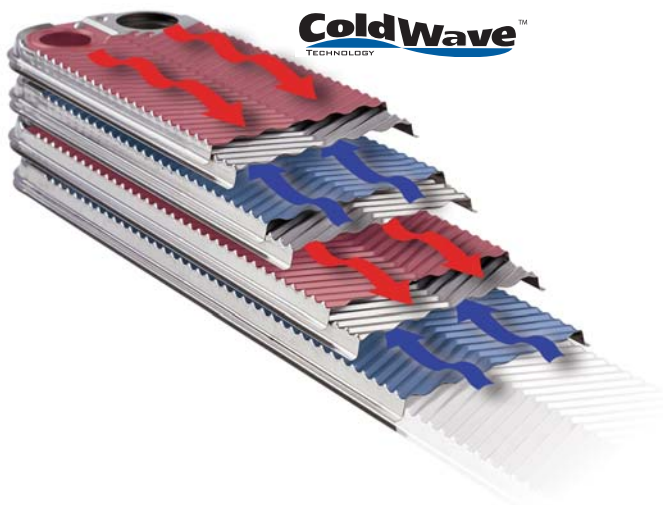

### 2. FILTRATION TECHNOLOGY

#### The Integrated HF Series Grade 9 Coalescing Separator/Filter

Once compressed air is cooled thermally, the condensed moisture must be effectively removed. A poorly designed separator can allow moisture to re-entrain itself into the compressed air stream. It is particularly challenging to consistently remove moisture at lower velocities (lower loads). The HF Series Grade 9 Separator/Filter effectively solves these challenges by utilizing two stages of filtration to remove bulk liquid and solid particulates to 3 micron in size.

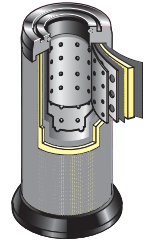

- **First stage** – two stainless steel orifice tubes provide 10 micron mechanical separation
- **Second stage** – in-depth fiber media captures solid and liquid particles to 3 micron in size

#### Make it an Air Treatment Station Integrated HF Series Grade 5 Coalescing Oil Removal Filter - Optional

Space and time savings can be achieved by integrating an oil removal coalescing filter into all HHD*plus* and HDS Series ColdWave™ refrigerated dryers. Instead of having a separate filter vessel and piping installed outside of the dryer...simply integrate it into the refrigerated dryer. This concept is what we call an "Air Treatment Station." The HF Series Grade 5 high efficiency oil removal filter effectively uses two stages of filtration to remove oil aerosols to 0.008 ppm (0.01 mg/m<sup>3</sup>) and solid particulates to 0.01 micron in size.

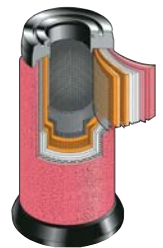

- **First stage** – multiple layers of fiber media and media screen remove larger particles, pre-filtering the air for the second stage
- **Second stage** – multiple layers of bonded, blended fiber media for fine coalescence captures fine oil aerosols and solid particles



### 3. DESIGN TECHNOLOGY

ColdWave™ dryers feature user friendly designs to empower you with a better solution. It begins with compressed air Inlet/Outlet connections located on one side (models through 1450 m³/h) or out the top (models 1500 m³/h and larger) to reduce piping complexity and to allow the back of the dryer to be positioned close to a wall so you have a more efficient use of floor space. Improved cabinet construction channels cooling air flow and reduces fan noise for quieter operation and better performance. Lift-out cabinet panels are designed for easy removal to provide easy and complete access to the interior for general maintenance.

- Compact Footprint: back-side of dryer can be placed against the wall
- Less Complex: Optional Grade 5 – premium air quality without piping complexity
- Easy Access: Lift-out panels provide easy access to the interior
- Quiet: Flow path for better ventilation and noise reduction
- Durable: proven reciprocating or scroll refrigeration compressors
- Environmentally Friendly Refrigerants: Complying with the Montreal Protocol of 1989, HFC refrigerants R-134a and R-404a, provide long-term availability at a reasonable cost
- Informative Controls: simple user interface, indicator lights and LCD text readouts (380 m³/h and larger) keep you informed
- Energy Efficient Drains: electric demand operated drain valves operate automatically without wasting any valuable compressed air
- Clean air: standard Grade 9 moisture separator/filter provides two-stage contaminant removal effective to 3 micron
- Cleaner air: add Grade 5 cold coalescing filtration to remove oil aerosols to 0.008 ppm w/w and 0.01 micron

#### Better Quality, Lower Costs

Hankison designs integral Grade 9 filtration into the air-side circuit of each ColdWave™ dryer. This minimizes costly system pressure drop, and delivers improved air quality – all without adding complexity or ancillary installation costs to your air system.

#### "Pre-Filter Required" Method

0,27 bar  $\Delta p$  + 0,34 bar  $\Delta p$  = 0,62 bar pressure drop



#### Energy Saving Hankison Method

0,35 bar  $\Delta p$  = 0,35 bar pressure drop

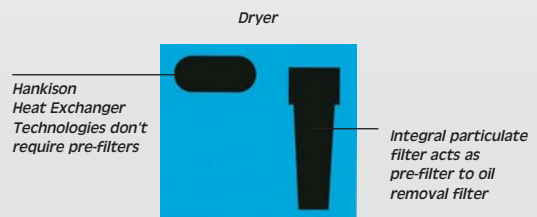

#### Hankison Heat Exchangers Eliminate the Pre-Filter: Calculate First-Year Savings

Air Flow		Pre-Filter Capital Cost	Pre-Filter Pressure Drop Cost*	Total First Year Cost of Pre-Filter
scfm	m³/h	€	€	€
100	172	429	292	720
250	429	762	729	1.490
500	859	1.310	1.456	2.765
1000	1717	1.905	2.912	4.817
2000	3434	3.214	5.825	9.039
3000	5151	4.405	8.737	13.142

\* Assuming a 0,27 bar pressure drop, 8,760 hours per year operation and € 0.10 / kWh energy cost.



## **COLDWAVE™ ENERGY SAVING REFRIGERATED DRYERS HDS SERIES, 1500 TO 10800 m<sup>3</sup>/h**

The Hankison Energy Saving (HDS) Series is one of the world's most commonly installed refrigerated air dryers for plants with varying levels of air demands. The Hankison technology platforms of precision design, engineered heat exchangers, quality filtration, and energy efficient digital evaporator refrigeration technology (see pgs 4-5), which are UL/CSA and wired to CE standards, represent the best value solution available for inconsistent heavy-duty air demand profiles.



### **DIGITAL EVAPORATOR TECHNOLOGY**

The HDS Series features groundbreaking technologies for the refrigerated dryer industry. The Digital Evaporator continues the Hankison tradition of low, stable dew point control – while providing tremendous energy savings for a rapid return-on-investment. Unlike most anything in the industry, the HDS Series, with proprietary Digital Evaporator Technology offers energy saving advantages over traditional non-cycling, cycling, and variable speed designs.

### **RAPID RETURN ON INVESTMENT (ROI)**

The HDS Series is designed to provide a rapid return on investment by:

- Reducing the dryer's energy consumption down to 9% (91% savings) at 0% load
- Precise matching of average air flow (heat load) with the required input kW power...No More...No Less
- Qualifying for energy rebates offered by utility companies
- Maintaining stable Class 4 and Class 5 dew points with no dew point spikes which send water downstream and cause high maintenance and downtime costs

### **HDS SERIES ENERGY SAVINGS PER YEAR**

Average Air Flow	Energy Consump.	HDS Series Energy Savings per Year by Model								
		1500	1800	2250	2700	3150	3600	4500	5400	
100%	100%	-	-	-	-	-	-	-	-	-
75%	78%	435	1281	1083	520	826	924	1089	1210	
50%	54%	774	1606	1587	1260	1652	1849	2252	2641	
25%	33%	1114	1931	2073	2001	2477	2773	3415	4071	
0%	9%	1453	2255	2567	2471	3303	3698	4578	5502	

Compared to non-cycling dryers: Assuming 35°C inlet and 25°C ambient temperature, 7 bar operating pressure, 8,760 working hours per year, € 0.084 / kWh energy cost.

### **THE HDS REFRIGERATION SYSTEM**

Digital Evaporator Technology controls the actions of the three core components in the refrigeration system (Digital Evaporator, Digital Control board, Digital Scroll refrigeration compressor) to provide true load-matching energy savings while maintaining low, stable dew point control.



## DIGITAL EVAPORATOR

Technology embedded in the Digital Evaporator recognizes varying heat loads between 0-100%, which result from the ever-changing Air Demand Profiles of compressed air users, and communicates dew point status to the Digital Control Board.

The air-to-air and air-to-refrigerant (Digital Evaporator) heat exchangers are uniquely sized and custom made. Each utilizes Hankison's advanced ColdWave™ heat exchanger technology (see page 4), crafted from premium grade 316 stainless steel. Pre-filtration is not required.

## DIGITAL CONTROL

The control board receives information from the Digital Evaporator and sends signals to the Digital Scroll refrigeration compressor. This determines the amount of cooling energy sent back to the Digital Evaporator. With a 60% air demand, for example, the control board tells the compressor to run loaded 60% of the time.....No More.....No Less.

### The HDS Series emm™ controller automatically scrolls through five LCD screens that display:

- Date/Time/Operating Status
- Hours-to-Service
- Total Compressor Operating Hours
- Instantaneous Load<sup>1</sup>
- Cumulative Energy Savings<sup>2</sup>

In addition, this control board has all the same standard features as found on the emm™ Energy Management Monitor of the HDD<sub>plus</sub> Series (see page 8), including the "schedule mode" for automatic start-stop operation.

## DIGITAL SCROLL



These innovative refrigeration scroll compressors are capable of running loaded or unloaded. Digital Scroll compressors unload by allowing the fixed upper scroll to move axially from the orbiting lower scroll.

<sup>1</sup> "Instantaneous Load" is displayed in "real time" as a percentage of design capacity. In the example above, it would display 60% load.

<sup>2</sup> "Cumulative Energy Savings" accept a cost/KwH value and projects the savings while using US Dollars or Euros for display symbols.

### True Load-Matching Energy Savings

Compare the 4 major technologies that compete in the refrigerated dryer segment. HDS Series (Energy Saving Dryers) are clearly the leader in energy savings, in all percentages of air demand. HDS Series refrigerated dryers add more profit to your bottom line.

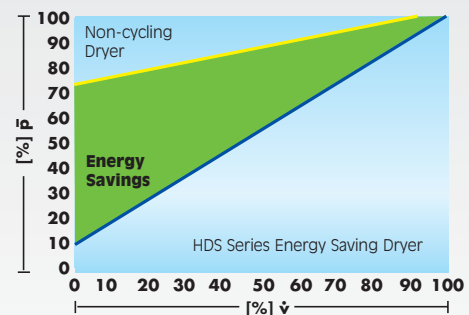
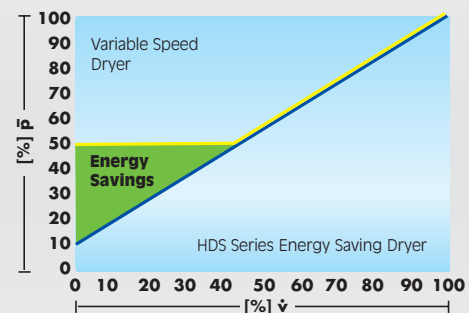
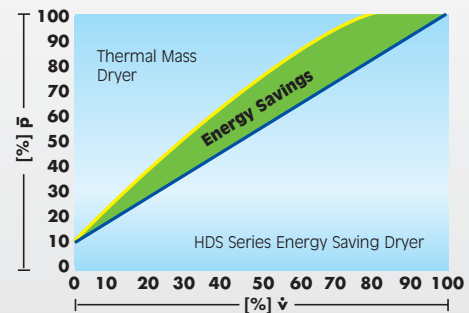

## **COLDWAVE™ NON-CYCLING REFRIGERATED DRYERS HHDplus SERIES, 211 TO 108000 m<sup>3</sup>/h**

The Hankison Performance and Reliability *plus* Filtration (HHD*plus*) Series is one of the world's most commonly installed refrigerated air dryers. The Hankison technology platforms of precision design, engineered heat exchangers, quality filtration, and rugged refrigeration (see pgs 4-5), which are UL/CSA and wired to CE standards, represent the best value solution available for heavy-duty air demand profiles.



### **HHDplus Series Operation and Filtration Models HHDP 211 to 301**

- On/off switch, Power-on light, and dew point temperature indicator- alerts operator to overload condition or refrigeration system fault
- HF Series Grade 9 Filter/Separator
- Optional HF Series Grade 5 coalescing oil removal filter

### **Models HHDP 381 to 10800 with the emm™ Energy Management Monitor**

- This advanced 24 volt electronic control package has many user-friendly interfaces which can save energy, automate service intervals, communicate in ten languages, and add functionality
- Energy-saving "schedule mode" allows compressed air users (see page 9) with one or two-shift operations to schedule the dryer to turn on and off in accordance with their work schedule
- Automatic service intervals can be set for predictive maintenance schedules: to ensure that the condenser on air-cooled units is maintained dust-free and to advise the replacement of the standard HF Series Grade 9 Separator/Filter element every 12 months, and the optional HF Series Grade 5 cold coalescing, oil removal filter
- Operator interface with read-outs comes standard in ten languages (English, German, French, Spanish, Italian, Polish, Danish, Dutch, Norwegian and Finnish). Read-outs include current time, operating status such as manual or schedule running modes, hours to service, and total operating hours.
- Functionality features include a drain push-to-test button, power-on and compressor-on lights, an operator alert light which indicates that service is required or that there is a refrigeration system or drain fault, dew point temperature indicator
- Remote monitoring of the emm™, from your computer, possible through the RS-232 Communication Port
- Standard NO and NC voltage-free alarm contacts and RS-232 Communication Port
- Fault condition diagnostics with user-friendly text display



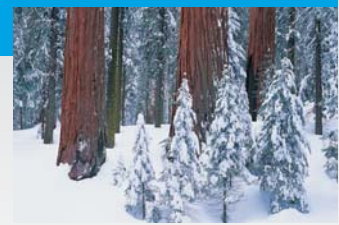

## COLDWAVE™ REFRIGERATED DRYERS, HOW THEY WORK

### AIR DRYING CIRCUIT - (Figure 1)

Compressed air, saturated with water vapor, enters the air-to-air heat exchanger (A), is pre-cooled by the outgoing chilled air, and then directed to the air-to-refrigerant (evaporator) heat exchanger (B) where it is further cooled by the refrigeration system. As the air is cooled, water vapor condenses into liquid droplets are removed by the Separator/Filter (C) and discharged from the dryer by an automatic drain (D). Air then goes through an Oil Removal Filter (optional) (E) and dry, oil-free, chilled air returns through the air-to-air heat exchanger where it is reheated before exiting the dryer.

### DIGITAL EVAPORATOR REFRIGERATION CONTROL

#### HDS Series - (Figure 2)

Digital Evaporator Technology monitors the incoming heat load to determine how much cooling energy is required to maintain stable dew point control. The digital emm™ control interprets the raw data from the Digital Evaporator and translates it into the amount of cooling energy that is needed. The digital emm™ control opens or closes the scrollenoid valve in precise time blocks that load or unload the Digital Scroll refrigeration compressor to match the varying heat loads. Dew point stability is achieved using the least amount of electrical energy that is necessary. No more...no less.

### HOT GAS BYPASS VALVE REFRIGERATION CONTROL

#### HHDp Series - (Figure 3)

Designed for rugged durability, the refrigeration compressors in HHDp dryers are the workhorses of the industry. Hot high-pressure refrigerant gas exits the compressor and changes state into a high-pressure liquid as it is cooled in the condenser. A thermal expansion valve controls the flow of cold low-pressure liquid refrigerant into the evaporator to ensure it is kept flooded for optimal heat transfer and dew point control. Warm low-pressure refrigerant gas exits the evaporator and completes the circuit as it returns to the suction-side of the refrigeration compressor. When operating at less than full design heat load conditions, the hot gas bypass valve introduces high-pressure gas into the cool low-pressure refrigerant to ensure low-pressure gas returns to the suction-side of the refrigeration compressor.

Figure 1 - Air Drying Circuit

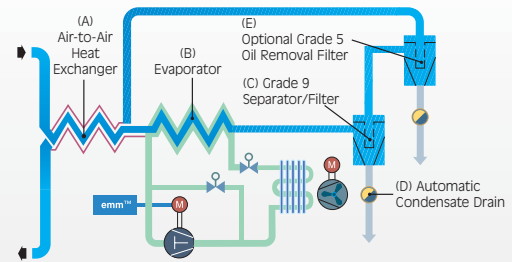

Figure 2 - Digital Evaporator Refrigeration Control

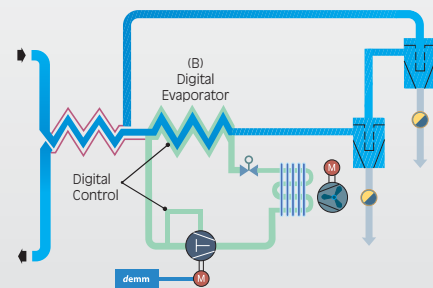
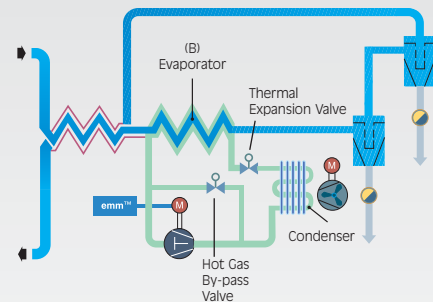

Figure 3 - Hot Gas Bypass Valve Refrigeration Control



## High Pressure Refrigerated Compressed Air Dryer, HPET Series for flows from 510 to 5550m<sup>3</sup>/h

PET is a polymer which is enjoying substantial growth as a packaging material - across global markets and for diverse applications. The growth of PET in packaging, as a replacement for glass, metal and other plastic materials, has been extraordinary. No other rigid plastic packaging sector has experienced the level of growth of PET bottles over the last 20 years. PET bottling machines use compressed air at 40 bar operating pressures and require a +3°C pressure dew point. Our High Pressure Refrigerated Compressed Air Dryer, HPET Series provides the consistent quality of air required, with a max working pressure of 45 bar.

Space-Saving Heat Exchangers compact, high-quality heat exchangers maintain stable +3°C dew points for the life of the unit.

Integrated Filter/Separator and Condensate Management: programmable electronic timed drains include highly accurate solid state timers with adjustments for valve open time.

### User-friendly instrumentation:

- Easy-to-read instrumentation includes: high dew point temperature, air-inlet temperature, dew point-temperature-display, air-outlet pressure, evaporation pressure gauge
- Lights are included
- A high pressure rest switch is also standard

Efficient and environmentally friendly refrigeration system

Complete your installation with the integration of compressed air filters Grade 9 (bulks liquid) before and 5 (High Efficiency Oil Removal Filter) after the high pressure refrigerated compressed air dryer.



max. working pressure of 45 bar

**The world market for PET-packaging is constantly growing - annual increases of 10% are usual. Take advantage of this opportunity with our HPET Series, you should not miss the opportunity.**

## High Inlet Temperature Compressed Air Dryer, HIT Series for flows from 26 to 177m<sup>3</sup>/h

### HIT makes it possible:

- Continuously dries and cleans without adjustments
- Pre-engineered systems...no need to select, purchase, install and maintain separate components
- Low pressure drop
- Easy to install: simply connect inlet and outlet connections to the air system, plug in and it is ready to operate
- Cools - accepts hot air directly from a compressor
- Dries - eliminates troublesome water from downstream air lines
- Cleans - includes an integral 3 micron coalescing filter- removing contaminants and oil aerosols
- Reheats - saves energy and prevents pipe sweating

All for one and One for all your needs:

Replaces the separate aftercooler, separator, dryer and filter package normally applied to a high temperature solution.



**Accepts high temperature air of up to +82°C directly from your compressor, no separate aftercooler and separator required.**



## Desiccant Dryer, DKC Series for flows from of 9 to 45m<sup>3</sup>/h



### Advantage at first sight:

#### Easy to install:

Dryers are supplied complete, pre-wired and ready for operation.

#### Easy to operate:

Individual adjustment of your desired dew point:

- 4 minutes cycle  
(dew point temperature of -70°C, inlet temperature of +35°C)
- 10 minutes cycle  
(dew point temperature of -40°C, inlet temperature of +35°C)

Perfect for wall mounting

Filtermonitor optional

## Activated carbon Tower, AK Series for flow capacities from 70 to 3600 m<sup>3</sup>/h

Perfect for the removal of remaining oil and hydrocarbon vapour after the applicable air drying and pre-filtration processes.

The result is high compressed air quality which can be used for many sensitive applications. Maintenance can be reduced as well. This dryer does not reduce CO/CO<sub>2</sub> or other methane, noxious gas or vapour.



## Pressure Swing Desiccant Dryer, HHL and HHS Series for flows from 70 to 9300m<sup>3</sup>/h



- Space-saving inter-connecting pipework
- Extremely user-friendly: the unique SensaSorb desiccant media allows an extremely long lifetime (up to 5 years)
- Space-saving integrated filtration
- Space-saving compact design provides the perfect solution for many different types of operation and application
- Moisture indicator - alerts operator of elevated dew point
- Large SensaSorb desiccant beds ensure long contact times and ensures wet saturated air at the dryer inlet, is dried to the required dew point

### The operating principle of desiccant dryers

Specifically for dew point temperatures from +3°C to -70°C or lower. These dryers are used where the air system is exposed to temperatures below freezing or when very dry air is required for critical applications.

Air passes through a tower containing desiccant media where water vapour is attracted to the surface of the desiccant. The saturated desiccant is continually regenerated and its lifespan, dependent upon the quality of air, can be several years. These regenerative dryers utilise twin towers technology, where the air supply is switched from tower to tower so that one tower is on-line drying while the other tower is off-line being regenerated.

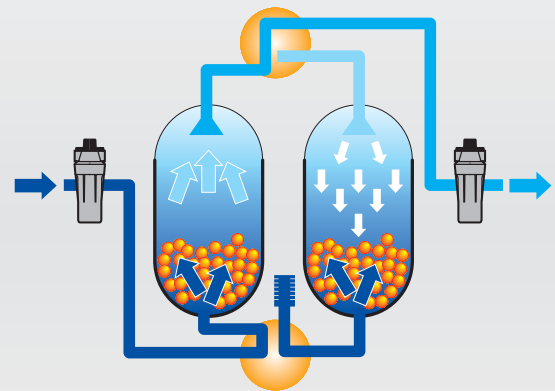

### The power of our Desiccant Dryers:

- Low investment costs
- Low maintenance costs  
(because of its simple construction and user-friendly operation)
- Easy installation and maintenance
- Constant low pressure dew point
- Most reliable performance!
- Exceptionally dry air (dew points from +3°C to -70°C)

Perfect harmony between service and products:  
All our desiccant dryers, DKC Series, HHL Series and HHS Series are all supplied ready for connection and immediate operation and include pre and after filters.

### Advantages for you:

- Gauges indicating storage pressure
- Front mounted operation panel
- Easy to handle and install
- Ready to operate



### Individual adjustment of your desired dew point:

- 4 minutes cycle (dew point temperature of  $-70^{\circ}\text{C}$ , and inlet temperature of  $+35^{\circ}\text{C}$ )
- 10 minutes cycle (dew point temperature of  $-40^{\circ}\text{C}$ , inlet temperature of  $+35^{\circ}\text{C}$ )
- 16 minutes cycle (dew point temperature of  $-20^{\circ}\text{C}$ , inlet temperature of  $+35^{\circ}\text{C}$ )
- 24 minutes cycle (dew point temperature of  $+3^{\circ}\text{C}$ , inlet temperature of  $+35^{\circ}\text{C}$ )

### The HHL Series:

- Level 1 Controller includes:
  - automatic drain and differential pressure gauge
  - (optional: Level 2 Controller)
- Operator alert light which indicates alarm messages



### Options on the HHS Series:

- Cabinet version up to model HHS Series 800
- The Level 2 controller allows you to choose your dew point. Includes tower pressure gauges, moisture indicator, purge flow indicator, tower status lights, mode selection indication, switching failure alarm.
- Failure alarm in 5 languages possible
- Level controlled condensate discharger

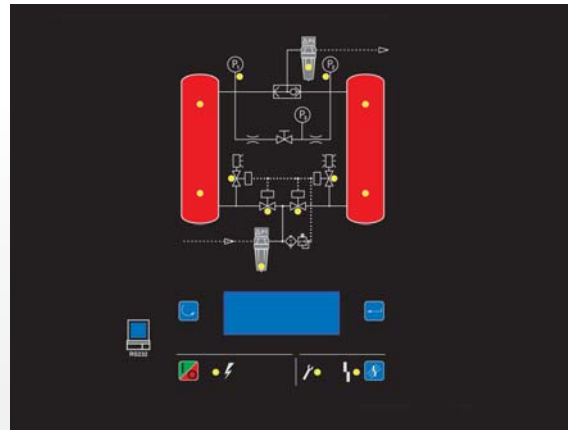

### Level2 Controller

#### Saves Energy:

- Minimizes purge air usage when operating at reduced loads
- Automatically matches purge air use with the demand of the system

#### User-friendly:

- Safe and reliable control of the loading phases and regeneration stage
- User selects between a normal and a severe service interval

#### That's already standard:

Filter monitors and level controlled drains are integrated into our filters.

#### Benefits to you:

- The Level 2 controller monitors the temperature rise within the desiccant compressed air dryer. Based on the readings, the control system manages the continuity of the drying and regeneration phases
- There are a choice out of four operating modes  $-70^{\circ}\text{C}$ ,  $-40^{\circ}\text{C}$ ,  $-20^{\circ}\text{C}$ ,  $+3^{\circ}\text{C}$
- Demand actuated Sensatherm-Energy savings for  $-40^{\circ}\text{C}$ ,  $-20^{\circ}\text{C}$ ,  $+3^{\circ}\text{C}$
- Service reminder LED lights for filters and drains, valves and desiccant
- Operational LED lights for power-on, tower status, valve status and tower pressure
- Alarm LED for tower switching failure, electronic demand drain alarms on filters
- Vacuum fluorescent text display communicates energy savings, operating mode and service reminders
- RS-232 communications port is standard Standard for HHS Series, as an option available for HHL Series

## The operating mode of the membrane dryer for dew point temperatures from +4°C to -40°C

The membrane dryers are used for applications where there is limited installation space, no power source available, or explosive or corrosive conditions exist. Choose the level of dryness your application requires.

Air passes through the inside of a semi-permeable hollow membrane fibre where water vapour diffuses through the fibre walls.

The diffusing process reduces the water content of the compressed air. Resulting in a pressure dew point reduction of 30°K, related to the inlet condition. The temperature of the compressed air is not affected, only it's dew point.

### HMM Series Drying with confidence

#### Convince yourself:

- Eliminate damaging water by reducing system pressure dew points as desired
- No moving parts to wear out
- Modular connections of the HMM Series and HF Series pre-filters and after-filters made for quick, clean and easy installations

#### Our advanced design features

- Special membrane fibre coating prevents hydrocarbon adsorption and maximizes handling of liquid water
- Helically wound fibre bundles gain an extremely high drying capacity in a space-saving package
- Structured fibre packing with consistent cross-sectional density provides greater energy efficiency, reduces pressure drop and eliminates by-pass channelling
- Rugged welded aluminium housings are lightweight and rugged for security under pressure
- Epoxy powder coated (both inside and out) for element protection

#### The Point-of-Use Alternative for low dew point application

- Revolutionary membrane design
- Unique outside-to-inside permeation increases surface area for more efficient drying
- Replaceable membrane bundles combine the convenience of a filter with the reliability of a dryer

#### No Oxygen loss - profit from the available oxygen for your further processes

#### Flexibility is one of our strengths:

Perfect for a desired flexible dew point. Dryers can be sized to produce dew point temperatures according to your needs.

Choose the level of dryness your application requires.

Perfect for climatic zones with high-temperature: Compressed air inlet temperature of up to +65°C are possible.







**NEW**  
**No oxygen loss**  
**GENERATION**

## HMD Series The next generation in membrane technology

### Extremely flexible:

- Maintains margin of drying protection

### Installation versatility:

- Operates in any orientation making it easy to install into existing equipment
- Lightweight-HMD Series dryers can be installed in air lines without additional support
- Operates in a wide variety of environments—high and low temperatures, corrosive and explosive atmospheres, indoors or outdoors and severe environments
- No power source is required
- No cooling-water needed
- Choice of pre-filter packages

### Install a HMD Series dryer and walk away:

- No operator required, no gauges to read, no adjustments to make
- No moving parts to maintain, repair or wear out
- No consumables (like deliquescent tablets) to replace
- Water is removed as vapour - no liquid condensate to eliminate from your pipes

### Scope of supply:

- Hankison HF Series Grade 5 High Efficiency Oil Removal Filter
- Automatic drain
- Differential pressure gauge

### High flow rates

*the design allows higher inlet and outlet flows*

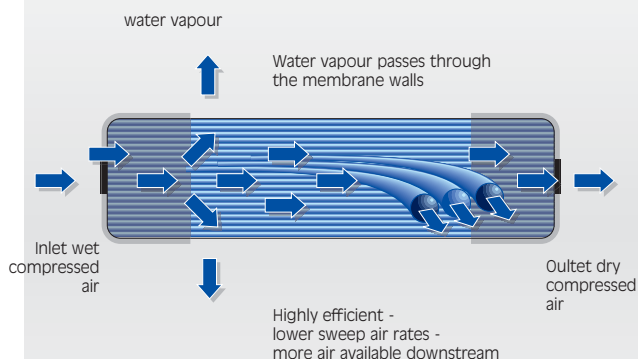

*The pressure dew point is influenced - among other conditions - by the size of the membrane surface and the time the air stays in contact with it. The longer air contacts the surface and the larger this surface actually is, the bigger the decrease of the dew point. Other conditions influencing the dew point are inlet temperature, inlet pressure dew point.*

Our membrane dryers are maintenance-free!  
Take advantage of this attribute!

## Compressed Air Filters: The 2-Stage Filtration makes the difference of purity

### Easy to operate

The pressure differential indicator shows the actual pressure drop

Enlarged flow paths reduce pressure drop

1/8 turn, self locking bayonet head to bowl connections (Size 12-28) from size 32 to 48 threaded headup to size 52: Filter Vessels

Large effective surface area - improves capture rate - ensure high efficiencies

### Easy to maintain

Can be mounted for either left or right entry

Integrated condensate drain for reliable discharge of collected liquids prevents air loss



### Easy to install

Modular connections - allow housings to be connected in series easily, while saving space  
Push on elements - make element replacement quick and easy

Manufactured from top quality aluminium and steel

Chromed and epoxy powder painted (interior and exterior) for additional durability and corrosion resistance

**Our 19 models are applicable for flows from 35 to 14850m<sup>3</sup>/h.**

## Methods of removing liquid contaminants:

### Separators

Liquid droplets are forced out of the air stream as the air is forced to spin or change direction. Separators remove heavy liquid loads and are effective on larger water droplets.

They are not, however, effective on sub-micronic oil aerosols.

◆HF Series Grades 11 & 9

### Coalescing-Filters/ In-Depth Filters

Coalescing filters are made of microfibers, which are pressed in a paper-like structure. This means, that the pore size is not exactly defined, as it is for absolute- or surface filtration. Coalescing filters work to the principle of depth filtration, where impingement due to Brownian movement plays an important rule. This principle enables filtration of water- and oil droplets down to 0.01 micron particle size. Coalescing filters filter from the inside to the outside of the filter element, in order to drain of the coalesced liquids into the sump of the filter housing.

◆HF Series Grades 7, 5, 3

HF Series Grade 6 removes dust and particles. The airflow takes place in the opposite direction, from the outside to the inside. ◆HF Series Grade 6

### Adsorbent Filters

These filters use a bed of active carbon to adsorb oil vapour and eliminate its subsequent odor. ◆HF Series Grade 1





### Filter Monitor

Audit your Compressed Air Filters for Energy Savings 50% Δp Savings Potential!

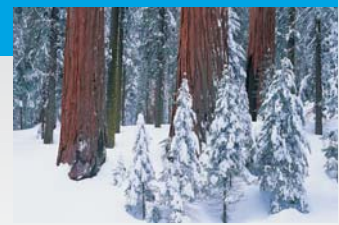
The Filter Monitor will allow you to control the exact amount of pressure drop you incur from centralized and point-of-use compressed air filtration. Timely warning and maintenance represents a Δp-savings of over 50%

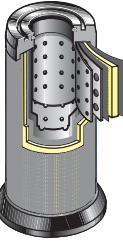
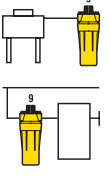
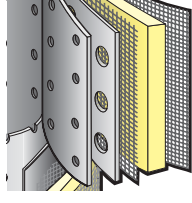
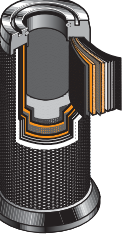
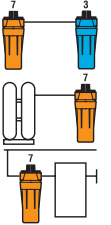
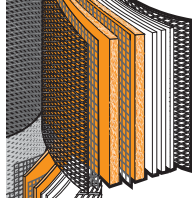
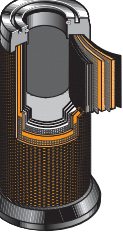
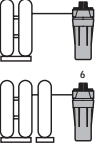
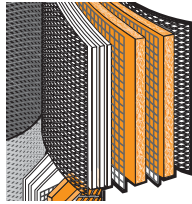
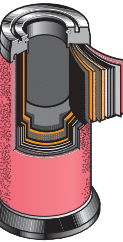
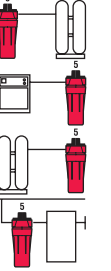
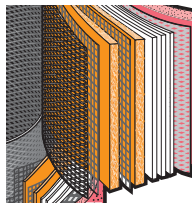
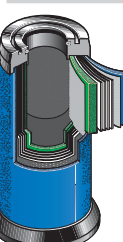
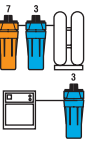
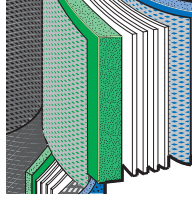

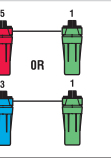

Model	Where used	The 2-Stage Filtration
 <p><b>HF 9:</b> Separator/Filter for bulk liquid removal. Features a 3 micron coalescing-filter. Removes water and oil aerosols up to 5.0 mg/m<sup>3</sup></p>	<p>Downstream of aftercoolers At point-of-use if no aftercooler/separator used upstream (heavily contaminated air)</p> 	<p>First Stage: two stainless steel orifice tubes provide 10 micron mechanical separation Second Stage: in-depth fibre media captures split and liquid particles to 3 microns</p> 
 <p><b>HF 7:</b> General purpose air line filter for removal of liquid water and oil. Removes solid particles to 1 micron (≤1.0mg/m<sup>3</sup>).</p>	<p>Upstream of ultra high efficiency oil removal filters Downstream of pressure-swing (heatless) desiccant dryers At point-of-use if aftercooler/separator installed upstream</p> 	<p>First Stage: captures larger particles with alternate layers of fibre media and media screen Second Stage: Coalesces aerosols and captures solid particles with multiple layers of epoxy bonded, blended fibre media</p> 
 <p><b>HF 6:</b> The standard filter for dust and particles removes dust and particles up to 1 micron.*</p>	<p>Downstream of pressure-swing (heatless) desiccant dryers Downstream of activated carbon towers</p> 	<p>First Stage: Captures larger particles with alternate layers of fibre media and media screen Second Stage: Captures solid particles with multiple layers of epoxy bonded, blended fibre media</p> 
 <p><b>HF 5:</b> High efficiency oil removal filter for coalescing fine water and oil aerosols; removes solid particles to 0.01 micron (≤0.01mg/m<sup>3</sup> remaining oil content*) Corrosion resistant inner and outer cores</p>	<p>Upstream of desiccant or membrane dryers Downstream of refrigerated dryers Downstream of pressure-swing desiccant dryers for fine particulate removal At point-of-use (may be used if light liquid load is present)</p> 	<p>First Stage: multiple layers of fibre media and media screen remove larger particles, prefiltering the air for the second stage. Second Stage: multiple layers of bonded, blended fibre media for fine coalescence Outer coated, closed cell foam sleeve</p> 
 <p><b>HF 3:</b> Ultra high efficiency oil removal filter Removes solid particles, water and oil aerosols to 0.01 micron (≤0.001mg/m<sup>3</sup> remaining oil content)</p>	<p>Upstream of desiccant or membrane dryers; use a filter No. 7 as a prefilter if heavy liquid loads are present Downstream of refrigerated dryers</p> 	<p>First Stage: coated, closed cell foam sleeve acts as prefilter and flow disperser Second Stage: multiple layers of matrix blended fibre media for ultra-fine coalescence Outer coated, closed cell foam sleeve To optimize the life-time install the prefilter grade 7</p> 
 <p><b>HF 1:</b> Oil vapour removal filter Active Carbon Filter for removal of oil aerosols and odours Remaining of oil content as vapour ≤ 0.003mg/m<sup>3</sup>.*</p>	<p>Downstream of high efficiency oil removal filters</p>  <p>fine carbon particles remove the remaining oil vapour. Multiple layers of fine media prevent particle migration. Outer coated, closed cell foam sleeve prevents fibre migration. Designed for 1000hour life at rated conditions (based on inlet temperature of +20°C and working pressure of 7bar. This dryer does not reduce CO/CO2 or other methane, noxious gas or vapour. To optimize the life-time install the prefilter grade 5</p>	<p>First Stage: A stabilized bed of finely divided carbon particles removes the majority of the oil vapour. Second Stage: Multiple layers of fibre media with bonded micro</p> 

\* All remainings of oil content based on inlet temperature of +20°C

## Refrigerated Compressed Air Dryer, HHD Series

Model	m <sup>3</sup> /h flow capacity	Working pressure max.	KW	Voltages	Connection	Dimensions			weight kg
						H	W	D	
HHD 21	20	16	0,21	230/1/50	3/8"	392	320	320	29
HHD 31	30	16	0,24	230/1/50	3/8"	392	320	320	31
HHD 61	60	16	0,47	230/1/50	3/4"	568	368	394	40
HHD 81	80	16	0,47	230/1/50	3/4"	568	368	394	42
HHD 101	100	16	0,63	230/1/50	3/4"	568	500	500	46

Dates are in accordance to DIN ISO 7183-1.  
Maximum operating pressure: 16bar, max.  
inlet temperature: +49°C. Conditions for dryer ratings are: compressed air at dryer inlet: 7bar and +35°C saturated, ambient temperature: +25°C Pressure dew point +3°C is ISO 8573.  
HHD21-101 230V/1PH/50HZ



correction factors for various inlet temperatures (°C)

inlet-temperatures	+25°C	+30°C	+35°C	+40°C	+45°C	+50°C	+55°C
Correction-factor	1,60	1,24	1	0,82	0,69	0,59	0,5

correction factors for various working pressures

bar	2	3	4	5	6	7	8	9	10	11	12	13	14	15	16
Correction Factor	0,70	0,80	0,87	0,92	0,96	1	1,03	1,05	1,07	1,08	1,10	1,11	1,12	1,13	1,14

Correction factors for various ambient temperatures: no correction necessary up to 49°C

## Refrigerated Compressed Air Dryer, HHD Series

Model	m <sup>3</sup> /h flow capacity	Working pressure max.	KW	Voltages	Connection	Dimensions			Weight kg
						H	W	D	
HHD 151	150	16	0,65	230/1/50	3/4"	510	483	526	42
HHD 180	180	16	0,61	230/1/50	1"	525	336	763	46
HHD 250	250	16	0,61	230/1/50	1 1/2"	525	336	763	51
HHD 295	295	16	0,88	230/1/50	1 1/2"	525	336	763	55
HHD 400	400	16	1	230/1/50	2"	718	440	915	73
HHD 500	500	16	1,46	230/1/50	2"	718	440	915	86
HHD 605	600	16	1,46	230/1/50	2"	760	520	966	86
HHD 800	800	16	1,97	230/1/50	DN 80	760	544	966	95



Date is in accordance to DIN ISO 7183-1.

Maximum operating pressure: 16bar, max. inlet temperature: +49°C. Conditions for dryer ratings are: compressed air at dryer inlet: 7bar and +35°C saturated, ambient temperature: +25°C Pressure dew point +3°C is ISO 8573.

HHD 151-HHD 800 230V/1PH/50H



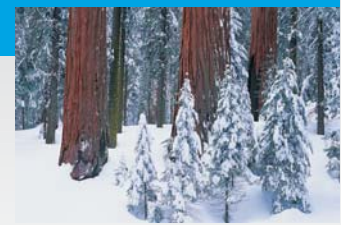

## Refrigerated Compressed Air Dryer, HHDp Series

Model	m <sup>3</sup> /h flow capacity	Working pressure max.	KW	Voltages	Connection	Dimensions			Weight kg
						H	W	D	
HHDp 211	210	16	0,55	230/1/50	1"	960	650	500	110
HHDp 261	260	16	0,55	230/1/50	1"	960	650	500	120
HHDp 301	300	16	0,98	230/1/50	1"	960	650	500	130
HHDp 381	380	16	1,00	400/3/50	1 1/2"	1230	820	820	210
HHDp 481	480	16	1,46	400/3/50	1 1/2"	1370	820	820	230
HHDp 601	600	16	1,60	400/3/50	1 1/2"	1370	820	820	260
HHDp 791	790	16	1,75	400/3/50	2"	1370	820	820	280
HHDp 951	950	16	2,25	400/3/50	2 1/2"	1510	820	1060	335
HHDp 1151	1150	16	2,55	400/3/50	2 1/2"	1510	820	1060	340
HHDp 1451	1450	16	2,99	400/3/50	2 1/2"	1510	820	1060	366
HHDp 1800	1800	16	4,90	400/3/50	DN 80	2162	1232	1039	780
HHDp 2250	2250	16	5,10	400/3/50	DN 100	2162	1232	1288	789
HHDp 2700	2700	16	6,40	400/3/50	DN 100	2162	1232	1288	839
HHDp 3150	3150	16	9,10	400/3/50	DN 150	2162	1400	1512	907
HHDp 3600	3600	16	9,80	400/3/50	DN 150	2162	1400	1512	953
HHDp 4500	4500	16	10,8	400/3/50	DN 150	2162	1400	1512	1015
HHDp 5400	5400	16	13,4	400/3/50	DN 150	2162	1400	1512	1027
HHDp 6300	6300	16	18,2	400/3/50	DN 200	2800	1438	2965	1850
HHDp 7200	7200	16	19,6	400/3/50	DN 200	2800	1438	2965	1950
HHDp 9000	9000	16	21,6	400/3/50	DN 200	2800	1438	2965	2080
HHDp 10800	10800	16	26,8	400/3/50	DN 200	2800	1438	2965	2090



## Energy Saving Compressed Air Treatment Plant, HDS Series

Model	m <sup>3</sup> /h flow capacity	Working pressure max.	KW	Voltages	Connection	Dimensions			Weight kg
						H	W	D	
HDS 1800	1800	16	3,1	400/3/50	DN 80	2162	1232	1039	780
HDS 2250	2250	16	4,3	400/3/50	DN 100	2162	1232	1288	789
HDS 2700	2700	16	5,9	400/3/50	DN 100	2162	1232	1288	839
HDS 3150	3150	16	6,7	400/3/50	DN 150	2162	1400	1512	907
HDS 3600	3600	16	7,5	400/3/50	DN 150	2162	1400	1512	953
HDS 4500	4500	16	9,4	400/3/50	DN 150	2162	1400	1512	1015
HDS 5400	5400	16	11,5	400/3/50	DN 150	2162	1400	1512	1027
HDS 6300	6300	16	13,4	400/3/50	DN 200	2800	1438	2965	1850
HDS 7200	7200	16	15,0	400/3/50	DN 200	2800	1438	2965	1950
HDS 9000	9000	16	18,8	400/3/50	DN 200	2800	1438	2965	2080
HDS 10800	10800	16	23,0	400/3/50	DN 200	2800	1438	2965	2090



correction factors for inlet temperatures and inlet pressures

Inlet Pressure:	Inlet Temperature:					
	25°C	30°C	35°C	40°C	45°C	50°C
3	1,42	1,00	0,79	0,63	0,51	0,43
4	1,50	1,08	0,87	0,72	0,60	0,52
5	1,57	1,13	0,92	0,77	0,65	0,56
6	1,63	1,18	0,96	0,81	0,68	0,60
7	1,67	1,22	1	0,84	0,71	0,63
8	1,72	1,25	1,03	0,87	0,74	0,65
9	1,76	1,29	1,07	0,91	0,78	0,67
10	1,81	1,33	1,10	0,93	0,80	0,70
11	1,84	1,36	1,13	0,96	0,82	0,73
12	1,87	1,38	1,16	0,98	0,84	0,75
13	1,90	1,41	1,18	1,00	0,86	0,77
14	1,93	1,44	1,21	1,02	0,88	0,80

correction factors for various ambient temperatures

Ambient Temperature	+25°C	+30°C	+35°C	+40°C	+45°C
Multiplier	1	0,94	0,89	0,83	0,78

HHD 211-10800 and HDS 1800-10800

Standard - 3 micron filter, Option 0,01 micron filter from HHDp380 EMM-Board and electric demand drain are included. Date is in accordance to DIN ISO 7183-1.

Maximum operating pressure: 16bar, max. inlet temperature: +49°C. Conditions for dryer ratings are: compressed air at dryer inlet: 7bar and +35°C saturated, ambient temperature:

+25°C Pressure dew point +3°C is ISO 8573.

HHD211-HHDp301 230V/1PH/50HZ/  
HHDp380-10800 400V/3PH/50HZ

## High Pressure Ref. Compressed Air Dryer, HPET Series

Model	m <sup>3</sup> /h flow capacity	Working pressure max.	KW	Voltages	Connection	Dimensions			Weight
						H	W	D	
HPET 1.0-700 E	510	45	1,05	400/3/50	DN 50	1277	1026	1223	168
HPET 1.5-700 E	740	45	1,46	400/3/50	DN 50	1277	1026	1223	172
HPET 2.0-700 E	1090	45	1,97	400/3/50	DN 50	1277	1026	1223	211
HPET 3.0-700 E	1360	45	2,93	400/3/50	DN 50	1277	1026	1223	218
HPET 5.0-700 E	1730	45	4,48	400/3/50	DN 50	1277	1026	1223	268
HPET 7.5-700 E	2900	45	5,19	400/3/50	DN 80	1464	1370	1605	465
HPET 10.0-700 E	3280	45	8,02	400/3/50	DN 80	1464	1370	1605	590
HPET 11.0-700 E	4100	45	10,21	400/3/50	DN 80	1464	1370	1605	710
HPET 12.0-700 E	5550	45	13,36	400/3/50	DN 80	1464	1370	1605	719



Rated flow capacity: max. working pressure at Tu = +25°C; Te = +35°C and 50Hz.  
HPET-1.0-700-HPET-12.0-700 = 400V/3Ph/50Hz

correction table inlet temperatures

inlet temperatures	+30°C	+35°C	+40°C	+45°C	+50°C	+55°C	+60°C
V(m <sup>3</sup> /h) to multiply by	1,18	1	0,84	0,73	0,64	0,55	0,49

correction table ambient temperatures

ambient temperatures	+25°C	+30°C	+35°C	+40°C	+45°C
V(m <sup>3</sup> /h) to multiply by	1	0,95	0,89	0,84	0,78

## High Inlet Temperature Air Dryer, HIT Series

Model	m <sup>3</sup> /h	Working pressure max.	KW	Voltages	Connection	Dimensions			Weight	Pressure lost
						H	W	D		
HIT 20	26	12	0,54	230/1/50	1/2"	718	257	327	35,8	0,2
HIT 25	33	12	0,54	230/1/50	1/2"	718	257	327	36,3	0,17
HIT 35	42	12	0,54	230/1/50	1/2"	718	257	327	36,7	0,2
HIT 50	78	12	0,99	230/1/50	3/4"	933	429	429	68	0,31
HIT 75	95	12	0,99	230/1/50	3/4"	933	429	429	70,3	0,15
HIT 100	141	12	1,99	230/1/50	3/4"	1162	439	428	84,8	0,21
HIT 125	177	12	1,99	230/1/50	3/4"	1162	439	428	85,7	0,26



for Air Flow: F1\*F2  
for Differential Pressure: F3\*F4

correction table air flow

Inlet temperature	+82°C	+70°C	+60°C	+50°C	
Inlet Pressure Dew Point		+71°C	+70°C	+60°C	+50°C
Working Pressure	Faktor 1				
12 bar		1,23	1,41	1,88	2,57
9 bar		1,11	1,26	1,72	2,39
7 bar		1	1,13	1,56	2,21
5 bar		0,86	0,96	1,36	1,97
3 bar		0,66	0,73	1,08	1,62
Ambient Temperature	40°C	35°C	30°C	25°C	
Faktor 2		0,95	1	1,05	1,11

correction table differential pressure

Inlet temperature	+82°C	+70°C	+60°C	+50°C	
Working Pressure	Faktor 3				
12 bar		0,93	1,20	2,11	3,87
9 bar		0,98	1,25	2,28	4,33
7 bar		1	1,25	2,36	4,65
5 bar		0,98	1,19	2,39	4,93
3 bar		0,87	1,03	2,23	4,95
Ambient Temperature	40°C	35°C	30°C	25°C	
Faktor 4		0,90	1	1,10	1,23

Max. working pressure: 12bar, max. inlet temperature: +82°C, max. ambient temperature: +43°C.  
Electrical connection: 230V/50Hz, refrigerant R 407c. Accepts compressed air directly from compressor, no aftercooler required.

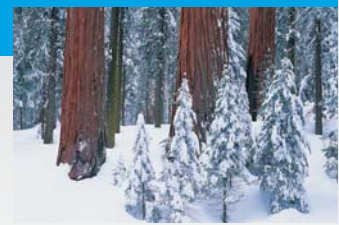

### Pressure Swing Desiccant Dryer, DKC Series

Model	m³/h	Working pressure max.	KW	Voltages	Connection	Dimensions			Weight kg
						H	W	D	
DKC 9	9	10	0,05	230/1/50	1/2" NPT	775	516	157	37
DKC 17	17	10	0,05	230/1/50	1/2" NPT	775	516	157	54
DKC 25	25	10	0,05	230/1/50	1/2" NPT	775	516	157	62
DKC 35	35	10	0,05	230/1/50	1/2" NPT	775	669	208	78
DKC 45	45	10	0,05	230/1/50	1/2" NPT	775	669	208	89



capacity correction factors for various inlet pressures

Inlet Pressure kgf/cm²	3	4	5	6	7	8	9	10
Multiplier	0,25	0,39	0,56	0,77	1	1,13	1,25	1,38

Air flow acc. to VDI 2045 based on: +20°C and 1bar absolute, working pressure: 7bar, max. working pressure: 10bar, max. inlet temperature: +49°C. Compressed air inlet temperature: +35°C, ambient temperature: +25°C, electrical connection 230V/50Hz, unit complete and ready for use, incl. each one pre- and afterfilter.

### Pressure Swing Desiccant Dryer, HHL / HHS Series

Model	m³/h	Working pressure max.	KW	Voltages	Connection	Dimensions			Weight kg
						H	W	D	
HHL / HHS 70*	70	16	0,05	230/1/50	R 1/2"	1920	750	750**	165
HHL / HHS 110*	110	16	0,05	230/1/50	R 3/4"	1920	750	750**	210
HHL / HHS 160*	160	16	0,05	230/1/50	R 3/4"	1930	750	750**	260
HHL / HHS 200*	200	16	0,05	230/1/50	R 1"	1950	1150	750**	310
HHL / HHS 300*	300	16	0,05	230/1/50	R 1"	1925	1150	750**	310
HHL / HHS 450*	450	16	0,05	230/1/50	R 1 1/2"	1965	1150	750**	460
HHL / HHS 650*	650	16	0,05	230/1/50	R 1 1/2"	1965	1150	750**	550
HHL / HHS 800*	800	16	0,05	230/1/50	R 2"	1965	1150	750**	615
HHL / HHS 1000	1000	10	0,05	230/1/50	DN 80	1950	1500	1300	1000
HHL / HHS 1350	1350	10	0,05	230/1/50	DN 80	1950	1500	1400	1225
HHL / HHS 1650	1650	10	0,05	230/1/50	DN 80	2070	1500	1450	1475
HHL / HHS 1950	1950	10	0,05	230/1/50	DN 80	2090	1500	1500	1700
HHL / HHS 2350	2350	10	0,05	230/1/50	DN 100	2190	1500	1700	1930
HHL / HHS 2700	2700	10	0,05	230/1/50	DN 100	2220	1700	1750	2180
HHL / HHS 3600	3600	10	0,05	230/1/50	DN 100	2300	1950	1900	2315
HHL / HHS 5150	5150	10	0,05	230/1/50	DN 100	2500	2400	2040	3860
HHL / HHS 7100	7100	10	0,05	230/1/50	DN 150	2610	2690	2300	4500
HHL / HHS 9300	9300	10	0,05	230/1/50	DN 150	2510	2820	2560	5445



\*Cabinet version up to model HHS Series 800 \*\* + 50mm

HHL and HHS  
Air flow acc. to VDI 2045 based on: +20°C and 1bar absolute, working pressure: 7bar, max. working pressure: 16bar, max. inlet temperature: +49°C. Compressed air inlet temperature: +35°C, ambient temperature: +25°C, electrical connection 230V/50Hz, unit complete and ready for use, incl. each one pre- and afterfilter.

inlet pressure correction factors

Working pressure	5	5,5	6	7	8	9	10	11	12	13	14	15	16
Multiplier	0,75	0,81	0,88	1	1,06	1,12	1,17	1,22	1,27	1,32	1,37	1,41	1,46

inlet temperature correction factors

Inlet Temperature	+38°C	+40°C	+43°C	+46°C	+49°C	+51°C
Multiplier	0,98	0,96	0,93	0,89	0,85	0,81

**Compressed Air Membrane Dryer, HMD Series**



Model	Working pressure max.	Connection	Length mm	Ø mm	Weight kg
HMD 20-1	14	R 3/8"	312	53	0,6
HMD 20-2	14	R 3/8"	671	53	0,8
HMD 20-3	14	R 3/8"	389	99	2,2
HMD 20-4	14	R 1/2"	683	99	3,1
HMD 20-5	14	R 1/2"	1041	99	4,9
HMD 20-6	14	R 3/4"	1050	125	6,0

HMD and HMM

For normal operation contains a Hankison HF Series Grade 5 high efficiency oil removal filter. Max. inlet liquid content: 1000ppm w/w, max. outlet oil content: 0,01 ppm w/w.

For highly contaminated systems or applications where the highest level of purity is required: contains a Hankison HF Series Grade 7 air line filter and a Hankison Grade 3 ultra high efficiency oil removal filter. Max. inlet liquid content: 2000 ppm w/w, max. outlet oil content: 0,001 ppm w/w.

⚡=m³/min /7bar DIN ISO 7183

**HMD 20-1**

inlet temperature		outlet pressure dew point					
		+10°C	+3°C	-10°C	-20°C	-30°C	-40°C
5 °C	Inlet				0,042	0,031	0,024
	Outlet				0,036	0,025	0,018
20 °C	Inlet			0,041	0,032	0,025	0,020
	Outlet			0,035	0,026	0,019	0,014
30 °C	Inlet		0,048	0,034	0,027	0,022	0,017
	Outlet		0,042	0,028	0,021	0,016	0,011
40 °C	Inlet	0,047	0,040	0,030	0,024	0,019	0,016
	Outlet	0,041	0,034	0,024	0,018	0,013	0,010
50 °C	Inlet	0,040	0,034	0,026	0,021	0,017	0,0147
	Outlet	0,034	0,028	0,020	0,015	0,011	0,008
66 °C	Inlet	0,032	0,028	0,022	0,018	0,015	0,012
	Outlet	0,026	0,022	0,016	0,012	0,009	0,006

**HMD 20-2**

inlet temperature		outlet pressure dew point					
		+10°C	+3°C	-10°C	-20°C	-30°C	-40°C
5 °C	Inlet				0,161	0,120	0,092
	Outlet				0,137	0,097	0,069
20 °C	Inlet			0,157	0,121	0,094	0,074
	Outlet			0,134	0,097	0,071	0,051
30 °C	Inlet		0,186	0,132	0,104	0,082	0,066
	Outlet		0,163	0,108	0,080	0,059	0,042
40 °C	Inlet	0,181	0,154	0,114	0,091	0,073	0,059
	Outlet	0,158	0,130	0,090	0,068	0,050	0,035
50 °C	Inlet	0,152	0,132	0,100	0,081	0,066	0,053
	Outlet	0,129	0,108	0,077	0,058	0,042	0,030
66 °C	Inlet	0,123	0,108	0,084	0,069	0,057	0,046
	Outlet	0,099	0,085	0,061	0,046	0,033	0,023

**HMD 20-3**

inlet temperature		outlet pressure dew point					
		+10°C	+3°C	-10°C	-20°C	-30°C	-40°C
5 °C	Inlet				0,256	0,201	0,162
	Outlet				0,222	0,167	0,127
20 °C	Inlet			0,252	0,202	0,165	0,135
	Outlet			0,218	0,167	0,130	0,101
30 °C	Inlet		0,291	0,217	0,178	0,147	0,122
	Outlet		0,256	0,182	0,144	0,113	0,087
40 °C	Inlet	0,284	0,247	0,192	0,160	0,134	0,111
	Outlet	0,250	0,212	0,158	0,126	0,099	0,077
50 °C	Inlet	0,245	0,217	0,173	0,146	0,122	0,102
	Outlet	0,210	0,183	0,139	0,111	0,088	0,068
66 °C	Inlet	0,204	0,184	0,150	0,128	0,108	0,091
	Outlet	0,170	0,150	0,116	0,093	0,073	0,056

**HMD 20-4**

inlet temperature		outlet pressure dew point					
		+10°C	+3°C	-10°C	-20°C	-30°C	-40°C
5 °C	Inlet				0,556	0,447	0,368
	Outlet				0,484	0,375	0,296
20 °C	Inlet			0,547	0,448	0,374	0,314
	Outlet			0,475	0,376	0,303	0,242
30 °C	Inlet		0,624	0,478	0,401	0,339	0,287
	Outlet		0,552	0,406	0,329	0,268	0,215
40 °C	Inlet	0,610	0,537	0,429	0,365	0,311	0,264
	Outlet	0,539	0,465	0,357	0,293	0,239	0,193
50 °C	Inlet	0,533	0,478	0,391	0,336	0,288	0,245
	Outlet	0,461	0,407	0,319	0,264	0,216	0,174
66 °C	Inlet	0,453	0,414	0,345	0,299	0,257	0,221
	Outlet	0,382	0,342	0,273	0,227	0,186	0,149

**HMD 20-5**

inlet temperature		outlet pressure dew point					
		+10°C	+3°C	-10°C	-20°C	-30°C	-40°C
5 °C	Inlet				0,922	0,735	0,601
	Outlet				0,802	0,615	0,480
20 °C	Inlet			0,907	0,737	0,611	0,509
	Outlet			0,787	0,617	0,491	0,389
30 °C	Inlet		1,039	0,789	0,657	0,552	0,463
	Outlet		0,918	0,669	0,537	0,432	0,343
40 °C	Inlet	1,016	0,889	0,705	0,596	0,504	0,425
	Outlet	0,895	0,769	0,584	0,475	0,384	0,305
50 °C	Inlet	0,882	0,790	0,640	0,546	0,465	0,394
	Outlet	0,762	0,669	0,520	0,425	0,344	0,273
66 °C	Inlet	0,746	0,679	0,562	0,483	0,414	0,352
	Outlet	0,626	0,559	0,441	0,363	0,293	0,232

**HMD 20-6**

inlet temperature		outlet pressure dew point					
		+10°C	+3°C	-10°C	-20°C	-30°C	-40°C
5 °C	Inlet				1,80	1,43	1,17
	Outlet				1,56	1,20	0,93
20 °C	Inlet			1,77	1,44	1,19	0,99
	Outlet			1,53	1,20	0,96	0,76
30 °C	Inlet		2,03	1,54	1,28	1,07	0,90
	Outlet		1,79	1,30	1,04	0,84	0,67
40 °C	Inlet	1,98	1,73	1,37	1,16	0,98	0,83
	Outlet	1,75	1,50	1,14	0,92	0,75	0,59
50 °C	Inlet	1,72	1,54	1,25	1,06	0,90	0,77
	Outlet	1,48	1,30	1,01	0,83	0,67	0,53
66 °C	Inlet	1,45	1,32	1,09	0,94	0,80	0,69
	Outlet	1,22	1,09	0,86	0,70	0,57	0,45



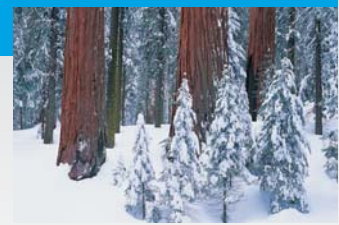

**Compressed Air Membrane Dryer, HMM Series**  
 $\dot{V} = \text{m}^3/\text{min} / 7\text{bar}$  **DIN ISO 7183**

Model	working pressure max.	Connection	Length mm	$\emptyset$ mm	Weight kg
HMM 1-3	16	R 3/8"	281	209	2,45
HMM 2-3	16	R 3/8"	387	209	2,77
HMM 3-4	16	R 1/2"	486	209	3,04
HMM 4-4	16	R 1/2"	696	209	3,58
HMM 5-6	16	R 3/4	498	267	4,9
HMM 6-6	16	R 3/4	696	267	6,19
HMM 7-8	16	R 1"	747	310	7,55
HMM 8-16	16	R 1"	885	346	15,88
HMM 9-16	16	R 1"	1040	346	18,14

**HMM-1**

inlet temperature		outlet pressure dew point					
		+10°C	+3°C	-10°C	-20°C	-30°C	-40°C
5 °C Inlet		x	x	0,047	0,030	0,022	0,016
Outlet		x	x	0,040	0,025	0,017	0,010
20 °C Inlet		0,077	0,049	0,030	0,022	0,017	0,013
Outlet		0,072	0,043	0,023	0,017	0,012	0,007
30 °C Inlet		0,047	0,355	0,025	0,019	0,015	0,011
Outlet		0,040	0,030	0,018	0,013	0,008	0,005
40 °C Inlet		0,034	0,029	0,021	0,017	0,013	0,010
Outlet		0,028	0,023	0,015	0,012	0,007	0,003
50 °C Inlet		0,028	0,024	0,018	0,015	0,012	0,009
Outlet		0,023	0,018	0,013	0,008	0,007	0,003
66 °C Inlet		0,023	0,020	0,015	0,013	0,010	x
Outlet		0,017	0,015	0,010	0,007	0,005	x

**HMM-2**

inlet temperature		outlet pressure dew point					
		+10°C	+3°C	-10°C	-20°C	-30°C	-40°C
5 °C Inlet		x	x	0,142	0,097	0,073	0,057
Outlet		x	x	0,125	0,080	0,057	0,042
20 °C Inlet		0,217	0,146	0,093	0,073	0,058	0,048
Outlet		0,202	0,130	0,078	0,057	0,043	0,033
30 °C Inlet		0,135	0,108	0,078	0,063	0,053	0,043
Outlet		0,120	0,093	0,063	0,048	0,037	0,028
40 °C Inlet		0,105	0,089	0,068	0,056	0,048	0,040
Outlet		0,090	0,073	0,053	0,042	0,0333	0,025
50 °C Inlet		0,088	0,078	0,062	0,052	0,044	0,037
Outlet		0,073	0,063	0,047	0,037	0,030	0,022
66 °C Inlet		0,073	0,066	0,053	0,046	0,039	x
Outlet		0,058	0,052	0,038	0,032	0,025	x

**HMM-3**

inlet temperature		outlet pressure dew point					
		+10°C	+3°C	-10°C	-20°C	-30°C	-40°C
5 °C Inlet		x	x	0,317	0,208	0,158	0,125
Outlet		x	x	0,277	0,168	0,118	0,085
20 °C Inlet		0,492	0,625	0,202	0,158	0,128	0,103
Outlet		0,453	0,487	0,163	0,120	0,090	0,065
30 °C Inlet		0,303	0,242	0,170	0,138	0,114	0,093
Outlet		0,265	0,203	0,132	0,100	0,077	0,055
40 °C Inlet		0,232	0,197	0,150	0,123	0,103	0,086
Outlet		0,195	0,160	0,133	0,087	0,065	0,048
50 °C Inlet		0,192	0,168	0,133	0,111	0,094	0,079
Outlet		0,155	0,131	0,097	0,075	0,057	0,042
66 °C Inlet		0,158	0,142	0,117	0,099	0,085	x
Outlet		0,122	0,105	0,080	0,063	0,048	x

**HMM-4**

inlet temperature		outlet pressure dew point					
		+10°C	+3°C	-10°C	-20°C	-30°C	-40°C
5 °C Inlet		x	x	0,425	0,287	0,222	0,175
Outlet		x	x	0,373	0,235	0,170	0,123
20 °C Inlet		0,633	0,433	0,280	0,217	0,180	0,147
Outlet		0,583	0,383	0,230	0,167	0,130	0,097
30 °C Inlet		0,400	0,317	0,233	0,192	0,160	0,133
Outlet		0,350	0,267	0,183	0,142	0,110	0,083
40 °C Inlet		0,308	0,267	0,205	0,173	0,145	0,123
Outlet		0,260	0,218	0,157	0,125	0,097	0,075
50 °C Inlet		0,258	0,230	0,183	0,157	0,133	0,113
Outlet		0,210	0,182	0,135	0,108	0,085	0,065
66 °C Inlet		0,217	0,197	0,163	0,140	0,122	x
Outlet		0,170	0,150	0,117	0,093	0,075	x

**HMM-5**

inlet temperature		outlet pressure dew point					
		+10°C	+3°C	-10°C	-20°C	-30°C	-40°C
5 °C Inlet		x	x	0,776	0,517	0,398	0,312
Outlet		x	x	0,673	0,423	0,305	0,218
20 °C Inlet		1,200	0,800	0,508	0,400	0,323	0,253
Outlet		1,110	0,710	0,418	0,310	0,233	0,173
30 °C Inlet		0,750	0,583	0,425	0,347	0,287	0,237
Outlet		0,662	0,495	0,337	0,258	0,198	0,148
40 °C Inlet		0,563	0,483	0,375	0,308	0,262	0,217
Outlet		0,477	0,397	0,288	0,222	0,175	0,130
50 °C Inlet		0,478	0,417	0,333	0,283	0,242	0,203
Outlet		0,392	0,330	0,247	0,197	0,155	0,117
66 °C Inlet		0,395	0,355	0,292	0,250	0,217	x
Outlet		0,312	0,272	0,208	0,167	0,133	x

**HMM-6**

inlet temperature		outlet pressure dew point					
		+10°C	+3°C	-10°C	-20°C	-30°C	-40°C
5 °C Inlet		x	x	1,183	0,817	0,633	0,508
Outlet		x	x	1,032	0,665	0,4782	0,357
20 °C Inlet		1,833	1,217	0,800	0,633	0,500	0,425
Outlet		1,687	1,070	0,653	0,487	0,362	0,278
30 °C Inlet		1,133	0,933	0,672	0,550	0,462	0,383
Outlet		0,988	0,788	0,527	0,405	0,317	0,238
40 °C Inlet		0,888	0,767	0,592	0,492	0,417	0,350
Outlet		0,747	0,625	0,450	0,350	0,275	0,208
50 °C Inlet		0,750	0,658	0,533	0,450	0,383	0,328
Outlet		0,610	0,518	0,393	0,310	0,243	0,188
66 °C Inlet		0,625	0,567	0,467	0,405	0,350	x
Outlet		0,488	0,430	0,330	0,268	0,213	x

**HMM-7**

inlet temperature		outlet pressure dew point					
		+10°C	+3°C	-10°C	-20°C	-30°C	-40°C
5 °C Inlet		x	x	2,233	1,550	1,192	0,925
Outlet		x	x	1,947	1,263	0,905	0,638
20 °C Inlet		3,416	2,333	1,500	1,167	0,950	0,783
Outlet		3,138	2,055	1,222	0,888	0,672	0,505
30 °C Inlet		2,133	1,750	1,267	1,033	0,850	0,705
Outlet		1,858	1,475	0,992	0,758	0,575	0,430
40 °C Inlet		1,675	1,442	1,100	0,917	0,767	0,650
Outlet		1,405	1,172	0,830	0,647	0,497	0,380
50 °C Inlet		1,417	1,250	0,988	0,833	0,717	0,605
Outlet		1,152	0,985	0,723	0,568	0,452	0,340
66 °C Inlet		1,167	1,050	0,867	0,742	0,642	x
Outlet		0,907	0,790	0,607	0,482	0,382	x

**Engineering Figures**

inlet temperature		outlet pressure dew point					
		+10°C	+3°C	-10°C	-20°C	-30°C	-40°C
5 °C	Inlet	x	x	3,195	2,333	1,833	1,500
	Outlet	x	x	2,795	1,933	1,433	1,100
20 °C	Inlet	4,833	3,342	2,283	1,833	1,500	1,250
	Outlet	4,443	2,952	1,893	1,433	1,110	0,860
30 °C	Inlet	3,167	2,583	1,950	1,617	1,350	1,133
	Outlet	2,783	2,200	1,567	1,233	0,967	0,750
40 °C	Inlet	2,500	2,167	1,725	1,450	1,250	1,050
	Outlet	2,123	1,790	1,348	1,073	0,873	0,673
50 °C	Inlet	2,133	1,900	1,550	1,333	1,150	0,975
	Outlet	1,763	1,530	1,180	0,963	0,780	0,605
66 °C	Inlet	1,783	1,642	1,367	1,200	1,033	x
	Outlet	1,422	1,280	1,005	0,838	0,672	x

HMM-8

inlet temperature		outlet pressure dew point					
		+10°C	+3°C	-10°C	-20°C	-30°C	-40°C
5 °C	Inlet	x	x	4,397	2,940	2,367	1,933
	Outlet	x	x	3,837	2,380	1,807	1,373
20 °C	Inlet	6,667	4,500	2,933	2,367	1,967	1,633
	Outlet	6,122	3,955	2,388	1,822	1,422	1,088
30 °C	Inlet	4,167	3,155	2,533	2,083	1,750	1,483
	Outlet	3,632	2,620	1,998	1,548	1,215	0,948
40 °C	Inlet	3,182	2,842	2,233	1,883	1,617	1,453
	Outlet	2,655	2,315	1,707	1,357	1,090	0,927
50 °C	Inlet	2,750	2,475	2,017	1,733	1,483	1,283
	Outlet	2,232	1,957	1,498	1,215	0,965	0,765
66 °C	Inlet	2,333	2,117	1,783	1,550	1,350	x
	Outlet	1,827	1,610	1,277	1,043	0,843	x

HMM-9

working pressure		5 bar	6 bar	7 bar	8 bar	9 bar	10 bar	11 bar	12 bar	13 bar
Dew point	+10°C	0,6	0,8	1,0	1,2	1,4	1,7	1,9	2,2	2,4
	+3°C	0,6	0,8	1,0	1,2	1,4	1,6	1,9	2,1	2,4
	-10°C	0,6	0,8	1,0	1,2	1,4	1,6	1,8	2,0	2,3
	-20°C	0,6	0,8	1,0	1,2	1,4	1,6	1,8	2,0	2,3
	-30°C	0,6	0,8	1,0	1,1	1,3	1,5	1,7	1,9	2,1
	-40°C	0,6	0,8	1,0	1,1	1,3	1,5	1,7	1,9	2,1

Correction factor is only an approximation for the inlet air flow

### Compressed Air Filters

Model	m³/h	Working pressure max.	Connection	Filterelement	Quantity	Dimensions		Weight kg
						H	W	
Modular Housings								
HF 9/7/6/5/3/1-12	35	16	3/8"	E-9/7/6/5/3/1-12	1	207	105	1,9
HF 9/7/6/5/3/1-16	60	16	1/2"	E-9/7/6/5/3/1-16	1	281	105	3,7
HF 9/7/6/5/3/1-20	105	16	1/2"	E-9/7/6/5/3/1-20	1	340	105	3,9
HF 9/7/6/5/3/1-24	170	16	3/4"	E-9/7/6/5/3/1-24	1	389	133	4,4
HF 9/7/6/5/3/1-28	290	16	1"	E-9/7/6/5/3/1-28	1	497	133	4,8
HF 9/7/6/5/3/1-32	425	16	1 1/2"	E-9/7/6/5/3/1-32	1	579	164	4,6
HF 9/7/6/5/3/1-36	640	16	1 1/2"	E-9/7/6/5/3/1-36	1	693	164	5,1
HF 9/7/6/5/3/1-40	825	16	2"	E-9/7/6/5/3/1-40	1	789	194	11,9
HF 9/7/6/5/3/1-44	1060	16	2 1/2"	E-9/7/6/5/3/1-44	1	935	194	13,7
HF 9/7/6/5/3/1-48	1325	13	2 1/2"	E-9/7/6/5/3/1-48	1	1091	194	15,5
Filter Vessels								
HF 9/7/6/5/3/1-52	1110	16	DN 80	E-9/7/6/5/3/1-PV	1	1038	260	16,3
HF 9/7/6/5/3/1-54	1700	16	DN 80	E-9/7/6/5/3/1-54	2	1219	406	41,3
HF 9/7/6/5/3/1-56	2125	16	DN 80	E-9/7/6/5/3/1-PV	2	1219	406	41,3
HF 9/7/6/5/3/1-60	3158	16	DN 100	E-9/7/6/5/3/1-PV	3	1245	413	54,4
HF 9/7/6/5/3/1-64	4250	16	DN 100	E-9/7/6/5/3/1-PV	4	1327	508	81,2
HF 9/7/6/5/3/1-68	5310	16	DN 100	E-9/7/6/5/3/1-PV	5	1327	508	82,6
HF 9/7/6/5/3/1-72	8490	16	DN 150	E-9/7/6/5/3/1-PV	8	1387	610	123
HF 9/7/6/5/3/1-76	11670	16	DN 150	E-9/7/6/5/3/1-PV	11	1589	711	235
HF 9/7/6/5/3/1-80	14850	16	DN 150	E-9/7/6/5/3/1-PV	14	1589	711	239

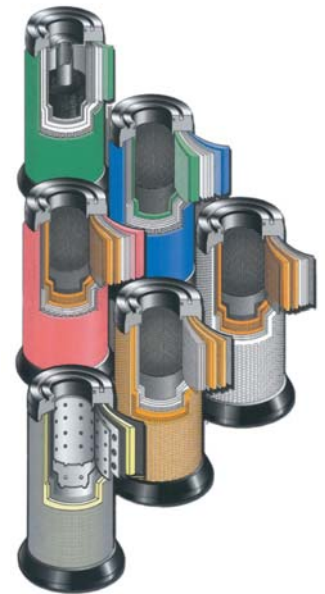

Working pressure: 7bar, max.  
working pressure: 16bar, max.  
working temperature: +66°C,  
flow calculated at 7bar.

Correction table air flow

min. working-pressure bar	2	3	4	5	6	7	8	9	10	11	12	13	14	15	16
Correction factor (HF 9-HF 3)	0,38	0,52	0,63	0,75	0,88	1	1,13	1,26	1,38	1,52	1,65	1,76	1,87	2,00	2,14

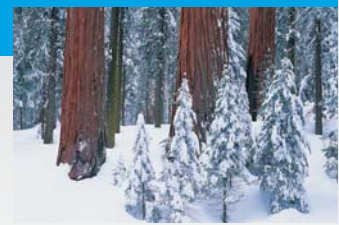

## ISO 8573.1 Air Quality Class

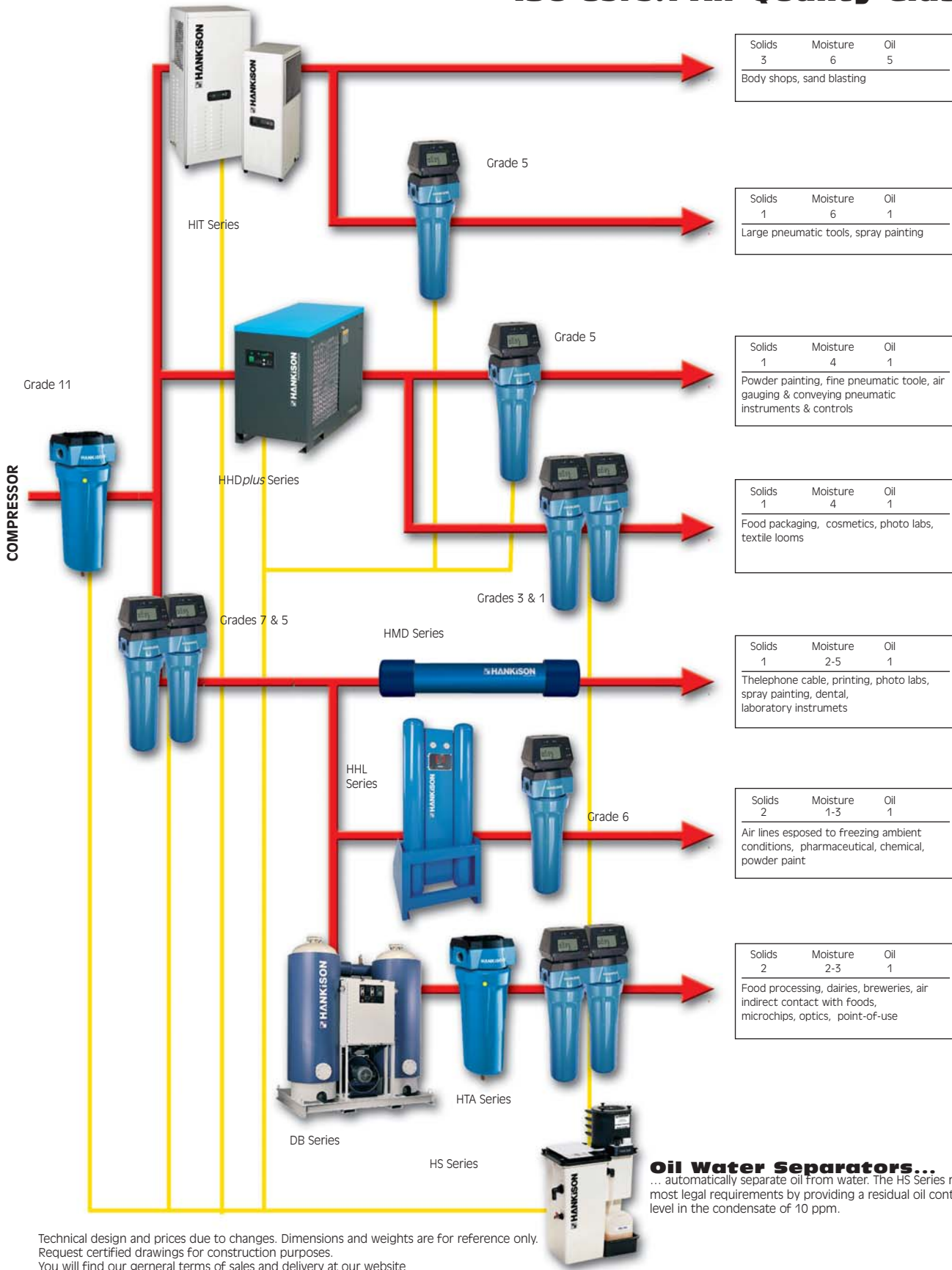

Technical design and prices due to changes. Dimensions and weights are for reference only. Request certified drawings for construction purposes. You will find our general terms of sales and delivery at our website <http://www.hankisonintl.de/agb.html>



From its early beginnings as a compressed air treatment pioneer in 1948, the Hankison brand has continued to expand its capabilities and technologies in designing and manufacturing compressed air dryers and filters.

Today we belong to the SPX Dehydration & Process Filtration group and are unified with other market leaders in compressed air treatment.

This permits us, Hankison, to ensure you the innovation, quality, reliability and availability you expect. You can rely on our unparalleled experience, advanced testing facilities, quality certifications, global presence, and competitive pricing.

We are able to meet your needs.

We are dedicated to supplying quality compressed air treatment products worldwide.

## **SPX** HANKISON

SPX Dehydration & Process Filtration GmbH  
 Konrad-Zuse-Straße 25  
 D-47445 Moers · Germany  
 Phone: + 49 (0) 28 41 / 8 19-0  
 Fax: + 49 (0) 28 41 / 8 19 83  
 email: [csc@dehydration.spx.com](mailto:csc@dehydration.spx.com)  
[www.hankisonintl.com](http://www.hankisonintl.com)

©2007 SPX Dehydration & Process Filtration. All rights reserved.

*Improvements and research are continuous at SPX Hankison  
 Specifications may change without notice.*

